



Introduction**Product Facts****Heavy Duty Seamless Electrical Lugs**

- High conductivity ETP copper
- Utilize seamless drawn body
- Flared wire barrel
- Copper and tin plating available
- Sight hole versions available for wire inspection
- Multiple tongue widths available
- Bent tongues available at angles up to 90°
- Many part numbers are UL listed

Heavy Duty Seamless Electrical Splices

- Utilize seamless tubular body
- Flared or chamfered wire barrel entry
- Dimpled wire stop for proper placement
- Tin plating

Industrial Electrical Lugs

- High conductivity ETP copper material
- Utilize seamless drawn body
- Tin plating
- Flared wire barrel
- Sight hole for wire inspection
- Color coding for crimp identification

Copper Compression Lugs and Splices

- Tubular copper body
- Sight hole for wire inspection
- Single and double stud hole available
- Long and short crimp barrel available
- Color coding for crimp identification
- Chamfered wire barrel entry
- Many part numbers are UL listed

Drawn Sleeves

- Capabilities to produce a wide range of custom drawn sleeves for electrical and electronic applications

The Heavy Duty Seamless and Copper Compression Lug and Splice line provides a robust terminal line for applications in the many industries. The product is used in applications including industrial and welding equipment, transportation/marine cable harness, and general-purpose harnesses. The Heavy Duty Seamless line utilizes deep-draw stamping technology to create a robust terminal without butted seams along the wire barrel or along the outer edge of the ring tongue. The Heavy Duty Splice line offers butt splice versions with either flared or chamfered wire barrels for ease of wire entry and dimpled wire stops to assist in proper wire placement.

The Copper Compression Lug and Splice line is a formed tubular line for use on cable assemblies in

Commercial equipment and Industrial machinery. The thicker tongue and wire barrel of this line provide added strength and rigidity for more challenging applications.

The Battery Lug and Splice line offers the thickest material and strength for your industrial equipment and transportation harness applications.

Tyco Electronics has extensive drawn sleeve capabilities to help meet your customized electrical sleeve needs. The company manufactures specialized sleeves used in general electrical applications and electronic components. Tyco Electronics has the capability to manufacture sleeves in a range of copper alloys and has extensive post electroplating capabilities. Contact us to review your application and discuss the benefits we can provide.

Need more information?

Call Technical Support at the numbers listed below.

Technical Support is staffed with specialists well versed in all Tyco Electronics products. They can provide you with:

- Technical support
- Catalogs
- Technical Documents
- Product Samples
- Tyco Electronics Authorized Distributor Locations

© Copyright 2002 by Tyco Electronics Corporation. All Rights Reserved.
AMP and TYCO are trademarks.

Table of Contents

Product Descriptions4-7

Stud Hole Size Chart/UL486A Chart8

Deep-Drawn Sleeves and Terminals

 Capabilities9

 Sleeve Illustrations and Part Numbers10

 Design Worksheet11

Heavy Duty Seamless Lugs and Splices

Seamless Ring Lugs12, 13

 8 AWG to 250 MCM

Seamless Ring Lugs with Sight Hole14, 15

 8 AWG to 250 MCM

Seamless Angled Ring Lugs16, 17

 8 AWG to 250 MCM

Seamless Angled Ring Lugs with Sight Hole18

 8 AWG to 250 MCM

Seamless Butt Splices19

 8 AWG to 4/0

Industrial Electrical Lugs and Splices

Industrial Lugs20

 8 AWG to 4/0

Industrial Butt Splices21

 8 AWG to 4/0

Copper Compression Lugs and Splices

Standard Barrel Lug with One Stud Hole22

 8 AWG to 500 MCM

Standard Barrel Lug with Two Stud Holes23

 8 AWG to 500 MCM

Long Barrel Lug with One Stud Hole24

 8 AWG to 500 MCM

Long Barrel Lug with Two Stud Holes25

 8 AWG to 500 MCM

Standard Barrel Butt Splices26

 8 AWG to 500 MCM

Long Barrel Butt Splices27

 8 AWG to 500 MCM

Design Worksheet28

Heavy Duty Starter/Battery Lugs and Splices

Super Lugs29

 4 AWG to 4/0

Super Butt Splices29

 4 AWG to 4/0

Crimp Tooling30

AMP to Former AET Part Number Cross Reference31-33

Former AET to AMP Part Number Cross Reference34-36

Part Number Index37-39

Heavy Duty Seamless Electrical Lugs

This line is made from high conductivity Electrolytic Tough Pitch (ETP) copper in a unique deep drawing process that enables the seamless characteristics. The seamless design provides advantages in a wide range of environmental and corrosive applications. The product incorporates a flared wire barrel to ease wire entry. The product has the wire gauge stamped on barrel for ease of identification. Different ring tongue pad widths and stud hole clearances are available for nearly any application. Versions with sight holes in the barrel are available to assist in wire inspection after crimping. Different angled versions are available to meet your many challenging applications, and custom bend angles can be quoted upon request. The product is available in copper or tin-plated copper varieties. The product is available in wire ranges from 8 AWG to 250 MCM.

**Angled Ring Tongue****Expanded Tongue**

Heavy Duty Seamless Butt Splices

This line incorporates high conductivity ASTM B-152 tubular copper material for a series of butt splices to meet most applications. The splices are available with either flared or chamfered barrels to ease in wire entry. Dimpled wire stop features are incorporated in each barrel to assist in proper wire placement for crimping. All products in this line are tin plated to provide additional corrosion protection.

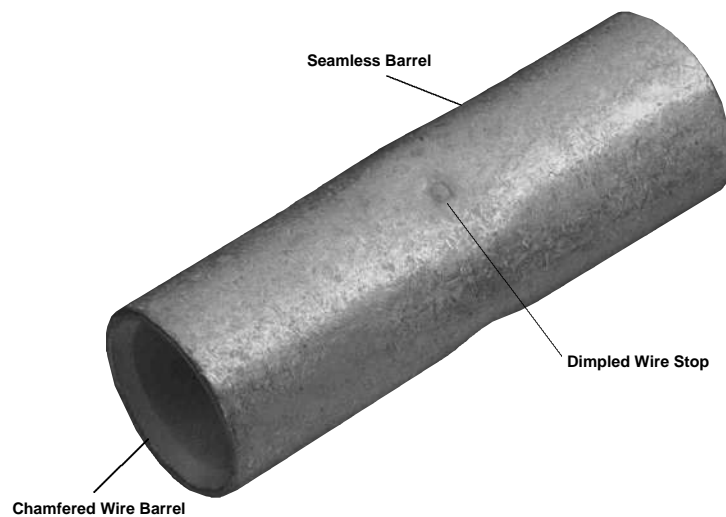
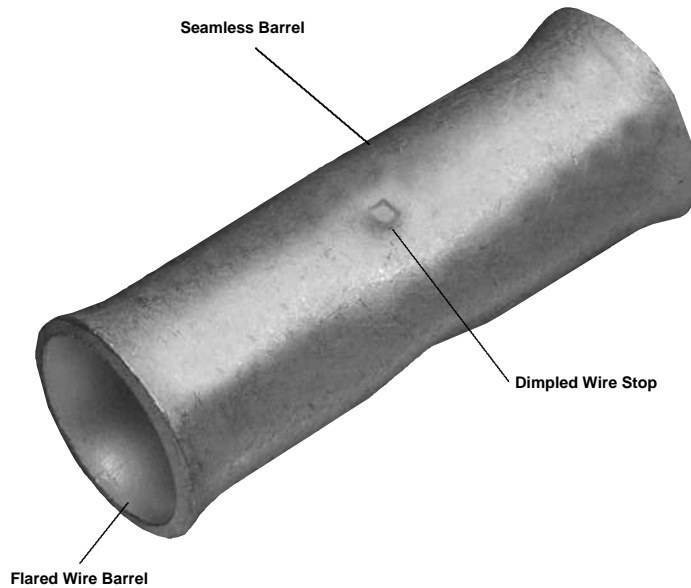

Industrial Electrical Lugs and Butt Splices

This line is made from high conductivity Electrolytic Tough Pitch (ETP) copper in a unique deep drawing process that enables the seamless characteristics. The seamless design provides advantages in a wide range of environmental and corrosive applications. The products in this line all have the wire size stamped on the barrel, a sight hole for wire inspection, tin plating, and coded barrels for wire and crimp identification. The product line is available in wire ranges from 8 AWG to 4/0.

The Butt Splices incorporate the same basic features as the standard Seamless Butt Splice line and are tin plated with color coded bands to wire and crimp identification.

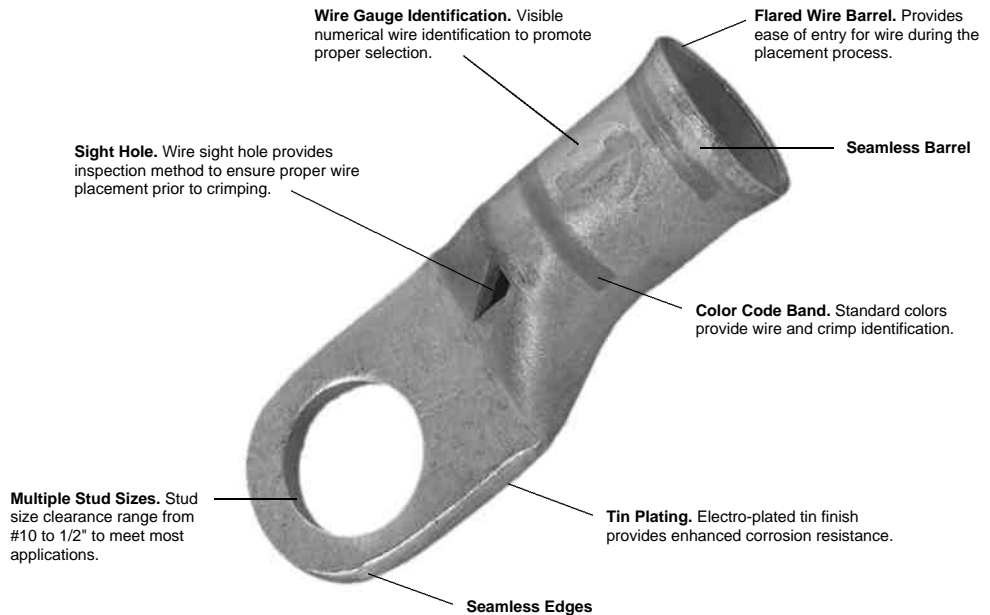

Copper Compression Lugs and Butt Splices

This line utilizes high conductivity ASTM B-75 tubular copper for a series of Copper Compression Lugs and Butt Splices for added strength and rigidity.

The Compression Lugs are available in single or double stud hole versions. A wide variety of stud hole sizes are available to meet most applications. The product line incorporates features including a chamfered wire barrel to ease wire entry, wire identification on the tongue, and a sight hole for wire inspection. The wire barrels are available in standard or long barrel to provide either a single or double crimp depending on the application. Each wire barrel has a color code band to identify the wire and crimp identification. The product line is available in wire ranges from 8 AWG to 500 MCM.



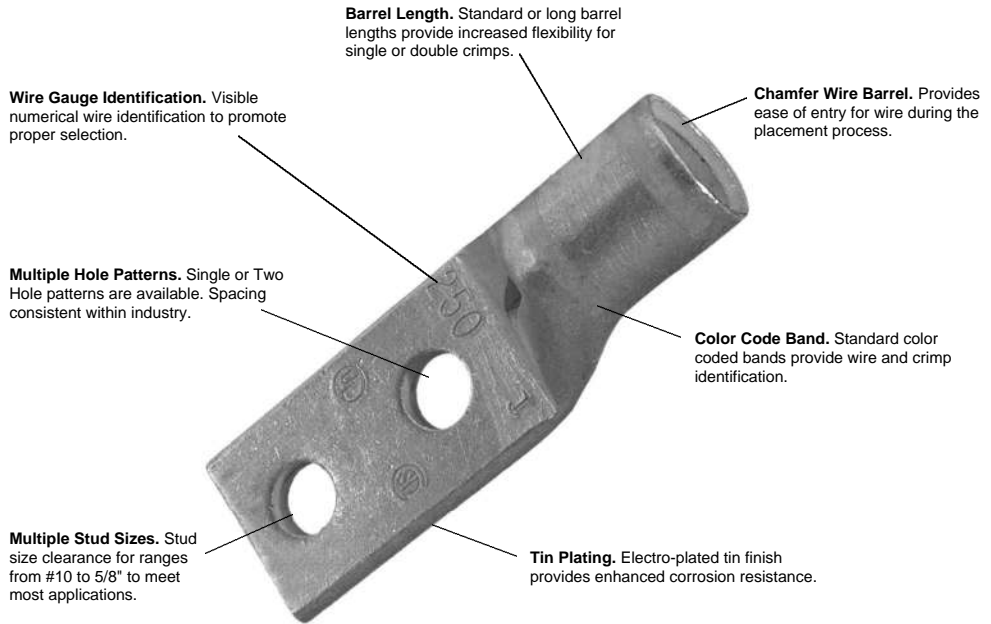





The Copper Compression Butt Splice line utilizes tubular copper for a series of standard and long barrel splices. All splices in this line have beneficial features including chamfered wire barrels and color coding for wire and crimp identification. Standard barrel products allow one crimp per wire, and long barrel products allows for two crimps for each wire. The product is available in wire ranges from 8 AWG to 500 MCM.







Stud Size Chart

Use to Select Proper Size Terminal

The chart shows sizes and dimensions of various studs and the corresponding terminal stud hole sizes used with AMP devices. For example, with stud #5 (.125 [3.18] Diameter), use AMP terminal device listed for #5 stud (.132 [3.35] Hole Diameter). Terminal stud hole sizes may easily be checked by fitting sample terminal to black circle.

| Stud Size | | Stud Dia. |  | Typical Terminal Stud Hole Diameter |
|------------|--------|--------------|---|-------------------------------------|
| U.S. Cust. | Metric | | | |
| #6 | M3.5 | .138 3.51 |  | .147 ± .005 3.73 ± 0.13 |
| #8 | M4 | .164 4.17 |  | .173 ± .005 4.39 ± 0.13 |
| #10 | — | .190 4.83 |  | .212 ± .005 5.38 ± 0.13 |
| #12 | — | .216 5.49 |  | .225 ± .005 5.72 ± 0.13 |
| #14 | — | .242 6.15 |  | .252 ± .005 6.40 ± 0.13 |
| 1/4" | M6 | .250 6.35 |  | .275 ± .005 6.99 ± 0.13 |
| 5/16" | M8 | .312 7.92 |  | .336 ± .005 8.53 ± 0.13 |
| 3/8" | — | .375 9.53 |  | .405 ± .005 10.29 ± 0.13 |

| Stud Size | | Stud Dia. |  | Typical Terminal Stud Hole Diameter |
|------------|--------|---------------|---|-------------------------------------|
| U.S. Cust. | Metric | | | |
| 7/16" | — | .437 11.10 |  | .463 ± .005 11.76 ± 0.13 |
| 1/2" | M12 | .500 12.70 |  | .525 ± .005 13.34 ± 0.13 |
| 5/8" | M16 | .625 15.88 |  | .645 ± .005 16.38 ± 0.13 |
| 3/4" | — | .750 19.05 |  | .780 ± .005 19.81 ± 0.13 |

Description of UL 486A Test Procedures and Requirements for Terminals

Wire Size Range AWG 8 to 500 MCM

Test Sequences

Test Group 1

Mechanical Sequence

1. Secureness
2. Pullout

Test Group 2

Mechanical Sequence

1. Secureness
2. Static Heat
3. Pullout

Pullout Test Requirements

Terminal must not be separate from wire when subjected to the listed load for one minute.

| Wire Size AWG | Pullout Force (lbs.) |
|------------------|-------------------------|
| 8 | 90 |
| 6 | 100 |
| 4 | 140 |
| 2 | 180 |
| 1/0 | 250 |
| 2/0 | 300 |
| 3/0 | 350 |
| 4/0 | 450 |
| 250 | 500 |
| 300 | 550 |
| 350 | 600 |
| 400 | 650 |
| 500 | 800 |

Note: Testing conducted on non-plated copper wire with UL approved insulation.

Static Heat Test Requirements

| Wire Size AWG | Test Current (Amperes) |
|------------------|---------------------------|
| 6 | 95 |
| 4 | 125 |
| 2 | 170 |
| 1/0 | 230 |
| 2/0 | 265 |
| 3/0 | 310 |
| 4/0 | 360 |
| 250 | 405 |
| 300 | 445 |
| 350 | 505 |
| 400 | 545 |
| 500 | 620 |

Requirement — Connector temperatures must not exceed the ambient temperature plus 50°C [90°F] after stability is attained.

Stability — A test sample is considered to have attained a stable temperature when three readings taken at not less than 10 minute intervals show no more than a 2°C [3.6°F] variation between any two readings.

Deep-Drawn Sleeve and Terminal Capabilities

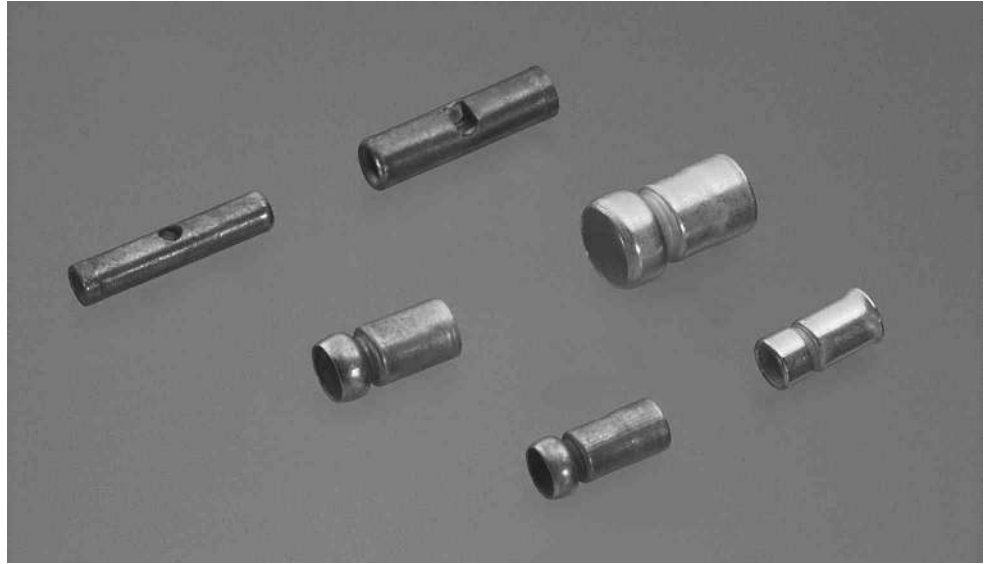

With the acquisition of American Electrical Terminal Co. in 2001, Tyco Electronics added extensive manufacturing capability for fabrication of high-volume precision seamless deep-drawn sleeves, thimbles, and terminal bodies. The deep-drawing process utilizes specialized high-speed equipment to extrude a wide range of materials into

customized electrical and electronic component bodies. Post-processing capabilities within Tyco include precision cleaning, secondary forming, and heat treatment processes. Furthermore, by utilizing the extensive precious and non-precious metal plating capabilities of Tyco Electronics, you can obtain completed components cost effectively from one source.

The table on page 10 lists some standard components and configurations available. The worksheet on page 11 can be used to specify a custom design for your application and receive a quote from Tyco Electronics.

Drawn Sleeves and Thimbles

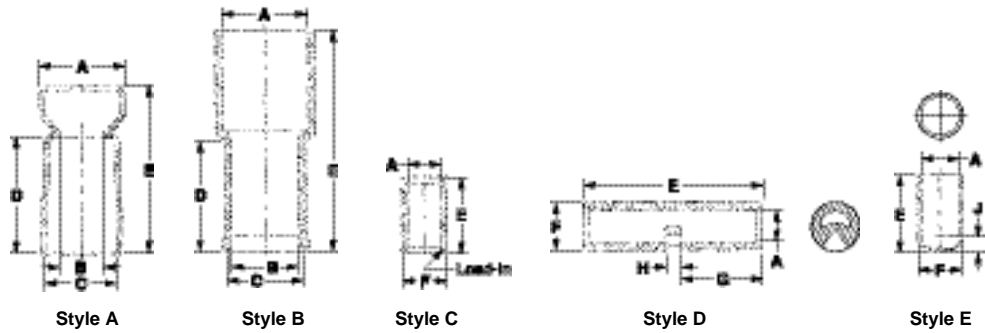

Drawn Funneled Sleeve

| Part Number | Style | A Dia. Min. | B Dia. Min. | C Dia. Min. | D Length Max. | E Length Max. | Material | Treatment | Finish |
|-------------|-------|--------------|--------------|--------------|---------------|---------------|----------|-----------|--------|
| 1527526-2 | A | .224 5.69 | .150 3.81 | .223 5.66 | .255 6.48 | .445 11.30 | Brass | — | Tin |
| 1527529-2 | A | .224 5.69 | .150 3.81 | .223 5.66 | .255 6.48 | .445 11.30 | Brass | Annealed | Tin |
| 1527530-2 | A | .157 3.99 | .100 2.54 | .161 4.09 | .263 6.68 | .378 9.60 | Brass | — | Tin |
| 1527531-2 | A | .157 3.99 | .100 2.54 | .161 4.09 | .258 6.55 | .378 9.60 | Brass | Annealed | Tin |
| 1527539-2 | A | .138 3.51 | .080 2.03 | .138 3.51 | .255 6.48 | .370 9.40 | Brass | Annealed | Tin |
| 1527546-2 | A | .138 3.51 | .080 2.03 | .138 3.51 | .255 6.48 | .370 9.40 | Brass | — | Tin |

Drawn Sleeve

| Part Number | Style | A Dia. Min. | B Dia. Min. | C Dia. Min. | D Length Max. | E Length Max. | Finish |
|-------------|-------|--------------|--------------|--------------|---------------|---------------|--------|
| 1527548-2 | B | .093 2.36 | .074 1.88 | .080 2.03 | .255 6.48 | .130 3.30 | Tin |

Drawn Inserts

| Part Number | Style | A Dia. Min. | F Dia. Max. | E Length Max. | Material | Treatment | Finish |
|-------------|-------|--------------|--------------|---------------|----------|-----------|--------|
| 1527514-2 | C | .150 3.81 | .202 5.13 | .340 8.64 | Steel | Annealed | Zinc |
| 1527516-2 | C | .088 2.24 | .135 3.43 | .310 7.87 | Steel | Annealed | Zinc |
| 1527523-1 | C | .150 3.81 | .202 5.13 | .340 8.64 | Steel | Annealed | — |

Drawn Butt Connector Barrels

| Part Number | Style | Wire Range | A Dia. Min. | F Dia. Max. | E Length Max. | G Length Nominal | H Nominal | Material | Treatment | Finish |
|-------------|-------|------------|--------------|--------------|---------------|------------------|--------------|----------|-----------|--------|
| 1527473-2 | D | 12-10 | .140 3.56 | .220 5.59 | .820 20.83 | .370 9.40 | .065 1.65 | Copper | Annealed | Tin |
| 1527480-2 | D | 16-14 | .095 2.41 | .160 4.06 | .670 17.02 | .300 7.62 | .065 1.65 | Copper | Annealed | Tin |
| 1527555-2 | D | 22-18 | .060 1.52 | .127 3.23 | .633 16.08 | .280 7.11 | .065 1.65 | Copper | Annealed | Tin |

Drawn Thimbles

| Part Number | Style | A Dia. Min. | F Dia. Max. | E Length Max. | J Nominal | Material | Finish |
|-------------|-------|---------------|---------------|----------------|--------------|----------|--------|
| 1526950-2 | E | .645 16.38 | .720 18.29 | 1.270 32.26 | .250 6.35 | Copper | Tin |

CUSTOMER INFORMATION: Review with Tyco Electronics Sales Engineer, Tyco Electronics Authorized Distributor, or fax to Tyco Electronics Technical Support.

Company Name _____ Your Name _____
 Address _____ City/State _____
 Telephone Number _____ Fax Number _____

SLEEVE STYLE

STRAIGHT 

FUNNELED 

PRODUCTION REQUIREMENTS

INITIAL QTY. _____ DUE DATE _____
 1ST YEAR QTY. _____ PROGRAM _____
 2ND YEAR QTY. _____ LIFE _____
 TARGET PRICE _____

CUSTOM SKETCH AREA
(Show Basic Shape & Dimensions)

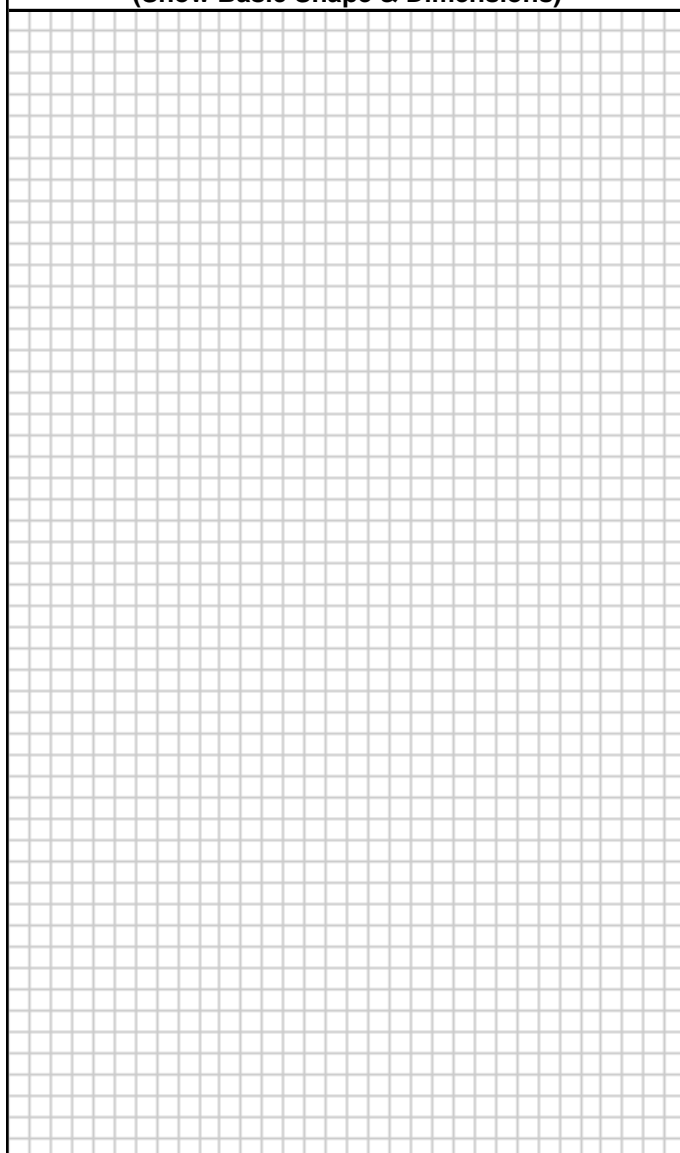

MATERIAL

BRASS SPECIFICATION _____
 COPPER _____
 STEEL _____
 OTHER _____



THICKNESS

.008" .010" .012"
 OTHER _____

PLATING

NONE TIN OTHER _____

SHAPE (LENGTH)

THIMBLE  TUBULAR 

SHAPE (WIDTH)

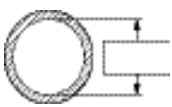
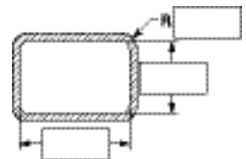
ROUND  SQUARE/RECTANGULAR 

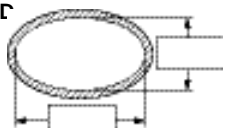
OVALIZED 

Fax or Mail to:
Attn: Tyco Electronics Technical Support, 2800 Fulling Mill Road, Middletown, PA 17057
Fax Number: 717-986-7575 Phone Number: 1-800-522-6752

Route to Product Manager GPL D90

Heavy Duty Seamless Lugs and Splices

Seamless Ring Lugs Wire Size Range 8 AWG to 1/0

Material

Terminal Body — Copper per ASTM B-152

Plating — Tin per ASTM B-545

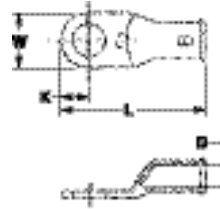

| Wire Size | Dimensions | | | | Stud Size | Part Numbers | | |
|----------------|---------------|----------------|---------------|---------------|--------------|--------------|------------|-----------|
| | D | L | W | K | | Plain Copper | Tin Plated | |
| 8 | .185 4.70 | 1.20 30.48 | .445 11.30 | .235 5.97 | 10 | 1526109-1 | 1526109-2 | |
| | | | | | 1/4 | 1526115-1 | 1526115-2 | |
| | | | | | 5/16 | 1526122-1 | 1526122-2 | |
| | | 1.305 33.15 | .605 15.37 | .315 8.00 | 1/4 | 1526128-1 | 1526128-2 | |
| | | | | | 5/16 | 1526134-1 | 1526134-2 | |
| | | | | | 3/8 | 1526142-1 | 1526142-2 | |
| | 1.48 37.59 | .765 19.45 | .395 10.03 | 3/8 | 1526148-1 | 1526148-2 | | |
| | | | | 1/2 | 1526154-1 | 1526154-2 | | |
| | | | | 10 | 1526160-1 | 1526160-2 | | |
| | 6 | .232 5.89 | 1.27 32.26 | .445 11.30 | .235 5.97 | 1/4 | 1526166-1 | 1526166-2 |
| | | | | | | 5/16 | 1526173-1 | 1526173-2 |
| | | | | | | 1/4 | 1526181-1 | 1526181-2 |
| 1.410 35.81 | | | .605 15.37 | .315 8.00 | 5/16 | 1526187-1 | 1526187-2 | |
| | | | | | 3/8 | 1526193-1 | 1526193-2 | |
| | | | | | 3/8 | 1526209-1 | 1526209-2 | |
| 1.55 39.37 | | .765 19.45 | .395 10.03 | 1/2 | 1526217-1 | 1526217-2 | | |
| | | | | 10 | 1526223-1 | 1526223-2 | | |
| | | | | 1/4 | 1526229-1 | 1526229-2 | | |
| 4 | | .286 7.26 | 1.50 38.1 | .525 13.33 | .275 6.98 | 5/16 | 1526235-1 | 1526235-2 |
| | | | | | | 3/8 | 1526242-1 | 1526242-2 |
| | | | | | | 5/16 | 1526251-1 | 1526251-2 |
| | 1.53 38.89 | | .625 15.88 | .325 8.25 | 3/8 | 1526258-1 | 1526258-2 | |
| | | | | | 3/8 | 1526267-1 | 1526267-2 | |
| | | | | | 1/2 | 1526282-1 | 1526282-2 | |
| | 1.68 42.85 | .765 19.45 | .395 10.03 | 1/2 | 1526290-1 | 1526290-2 | | |
| | | | | 1/4 | 1526290-1 | 1526290-2 | | |
| | | | | 5/16 | 1526397-1 | 1526397-2 | | |
| | | | | 3/8 | 1526405-1 | 1526405-2 | | |
| | | | | 3/8 | 1526415-1 | 1526415-2 | | |
| | | | | 1/2 | 1526431-1 | 1526431-2 | | |
| 2 | .336 8.53 | 1.62 41.27 | .615 15.62 | .325 8.25 | 1/4 | 1526437-1 | 1526437-2 | |
| | | | | | 3/8 | 1526452-1 | 1526452-2 | |
| | | | | | 1/2 | 1526459-1 | 1526459-2 | |
| | | 1.75 44.45 | .755 19.18 | .395 10.03 | 3/8 | 1526465-1 | 1526465-2 | |
| | | | | | 1/2 | 1526431-1 | 1526431-2 | |
| | | | | | 1/4 | 1526437-1 | 1526437-2 | |
| | 1.72 43.69 | .655 16.64 | .335 8.51 | 3/8 | 1526452-1 | 1526452-2 | | |
| | | | | 1/2 | 1526459-1 | 1526459-2 | | |
| | | | | 3/8 | 1526465-1 | 1526465-2 | | |
| | | | | 1/2 | 1526479-1 | 1526479-2 | | |
| | | | | 1/4 | 1526490-1 | 1526490-2 | | |
| | | | | 5/16 | 1526596-1 | 1526596-2 | | |
| 1 | .360 9.14 | 1.83 46.48 | .755 19.18 | .395 10.03 | 3/8 | 1526704-1 | 1526704-2 | |
| | | | | | 1/2 | 1526479-1 | 1526479-2 | |
| | | | | | 1/4 | 1526490-1 | 1526490-2 | |
| | | 1.83 46.48 | .725 18.41 | .385 9.78 | 5/16 | 1526596-1 | 1526596-2 | |
| | | | | | 3/8 | 1526704-1 | 1526704-2 | |
| | | | | | 1/2 | 1526713-1 | 1526713-2 | |
| | 1.90 48.41 | .825 20.96 | .425 10.80 | 3/8 | 1526719-1 | 1526719-2 | | |
| | | | | 1/2 | 1526731-1 | 1526731-2 | | |
| | | | | 1/2 | 1526731-1 | 1526731-2 | | |
| | 1/0 | .407 10.33 | 1.83 46.48 | .725 18.41 | .385 9.78 | 5/16 | 1526596-1 | 1526596-2 |
| | | | | | | 3/8 | 1526704-1 | 1526704-2 |
| | | | | | | 1/2 | 1526713-1 | 1526713-2 |
| 1.90 48.41 | | | .825 20.96 | .425 10.80 | 3/8 | 1526719-1 | 1526719-2 | |
| | | | | | 1/2 | 1526731-1 | 1526731-2 | |
| | | | | | 1/2 | 1526731-1 | 1526731-2 | |

Heavy Duty Seamless Lugs and Splices (Continued)

Seamless Ring Lugs

(Continued)

Wire Size Range
2/0 AWG to 250 MCM

Material

Terminal Body — Copper per ASTM B-152

Plating — Tin per ASTM B-545

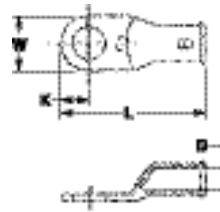

| Wire Size | Dimensions | | | | Stud Size | Part Numbers | |
|-----------|----------------------|----------------------|-----------------------|----------------------|-----------|--------------|------------|
| | D | L | W | K | | Plain Copper | Tin Plated |
| 2/0 | .461 11.71 | 2.06 52.37 | 8.15 20.70 | .425 10.80 | 1/4 | 1526738-1 | 1526738-2 |
| | | | | | 5/16 | 1526745-1 | 1526745-2 |
| | 3/8 | 1526758-1 | 1526758-2 | 1/2 | 1526781-1 | 1526781-2 | |
| | 1/4 | 1526793-1 | 1526793-2 | 5/16 | 1526799-1 | 1526799-2 | |
| 3/0 | .511 12.98 | 2.16 54.86 | .895 22.73 | .465 11.81 | 3/8 | 1526805-1 | 1526805-2 |
| | | | | | 1/2 | 1526819-1 | 1526819-2 |
| | 1/4 | 1526830-1 | 1526830-2 | 5/16 | 1526837-1 | 1526837-2 | |
| | 3/8 | 1526844-1 | 1526844-2 | 1/2 | 1526852-1 | 1526852-2 | |
| 4/0 | .559 14.20 | 2.35 59.69 | .985 25.02 | .505 12.83 | 3/8 | 1526863-1 | 1526863-2 |
| | | | | | 1/2 | 1526873-1 | 1526873-2 |
| | .590 14.99 | 2.39 60.71 | 1.035 26.29 | .525 13.33 | 5/8 | 1526883-1 | 1526883-2 |
| | | | | | 3/8 | 1526892-1 | 1526892-2 |
| | .625 15.87 | 2.46 62.68 | 1.09 27.76 | .555 14.10 | 1/2 | 1526911-1 | 1526911-2 |
| | | | | | 5/8 | 1526922-1 | 1526922-2 |
| 250 MCM | .685 17.40 | 2.65 67.46 | 1.20 30.55 | .605 15.37 | 3/8 | 1526928-1 | 1526928-2 |
| | | | | | 1/2 | 1526934-1 | 1526934-2 |
| | | | | | 5/8 | 1526941-1 | 1526941-2 |

Heavy Duty Seamless Lugs and Splices (Continued)

Seamless Ring Lugs with Sight Holes

Wire Size Range
8 AWG to 1/0

Material

Terminal Body — Copper per ASTM B-152

Plating — Tin per ASTM B-545



| Wire Size | Dimensions | | | | Stud Size | Part Numbers | |
|-----------|----------------------|-------------|-------------|-------------|-----------|--------------|------------|
| | D | L | W | K | | Plain Copper | Tin Plated |
| 8 | .185 4.70 | 1.20 | .445 | .235 | 10 | 1526110-1 | 1526110-2 |
| | | 30.48 | 11.30 | 5.97 | 1/4 | 1526116-1 | 1526116-2 |
| | | | | | 5/16 | 1526123-1 | 1526123-2 |
| | | | | | 1/4 | 1526129-1 | — |
| | | | | | 5/16 | 1526135-1 | 1526135-2 |
| | | | | | 3/8 | 1526143-1 | 1526143-2 |
| | | | | 3/8 | 1526149-1 | — | |
| | | | | 1/2 | 1526155-1 | 1526155-2 | |
| | | | | 10 | 1526161-1 | 1526161-2 | |
| | | | | 1/4 | 1526167-1 | 1526167-2 | |
| | | | | 5/16 | 1526174-1 | 1526174-2 | |
| | | | | 1/4 | 1526182-1 | 1526182-2 | |
| 6 | .232 5.89 | 1.27 | .445 | .235 | 10 | 1526188-1 | 1526188-2 |
| | | 32.26 | 11.30 | 5.97 | 1/4 | 1526174-1 | 1526174-2 |
| | | | | | 5/16 | 1526182-1 | 1526182-2 |
| | | | | | 1/4 | 1526188-1 | 1526188-2 |
| | | | | | 3/8 | 1526194-1 | 1526194-2 |
| | | | | | 3/8 | 1526210-1 | 1526210-2 |
| | | | | 1/2 | 1526218-1 | 1526218-2 | |
| | | | | 10 | 1526224-1 | 1526224-2 | |
| | | | | 1/4 | 1526230-1 | 1526230-2 | |
| | | | | 5/16 | 1526236-1 | 1526236-2 | |
| | | | | 3/8 | — | 1526243-2 | |
| | | | | 5/16 | 1526252-1 | 1526252-2 | |
| | | | 3/8 | 1526259-1 | 1526259-2 | | |
| | | | 3/8 | 1526268-1 | 1526268-2 | | |
| | | | 1/2 | 1526283-1 | 1526283-2 | | |
| 4 | .286 7.26 | 1.50 | .525 | .275 | 1/4 | 1526291-1 | 1526291-2 |
| | | 38.1 | 13.33 | 6.98 | 5/16 | 1526398-1 | 1526398-2 |
| | | | | | 3/8 | — | 1526406-2 |
| | | | | | 5/16 | 1526252-1 | 1526252-2 |
| | | | | | 3/8 | 1526259-1 | 1526259-2 |
| | | | | | 3/8 | 1526268-1 | 1526268-2 |
| | | | | 1/2 | 1526283-1 | 1526283-2 | |
| | | | | 1/4 | 1526291-1 | 1526291-2 | |
| | | | | 5/16 | 1526398-1 | 1526398-2 | |
| | | | | 3/8 | — | 1526406-2 | |
| | | | | 3/8 | 1526416-1 | 1526416-2 | |
| | | | | 1/2 | 1526432-1 | 1526432-2 | |
| | | | 1/4 | — | 1526438-2 | | |
| | | | 5/16 | 1526443-1 | 1526443-2 | | |
| | | | 3/8 | 1526453-1 | 1526453-2 | | |
| | | | 3/8 | 1526466-1 | 1526466-2 | | |
| | | | 1/2 | 1526480-1 | 1526480-2 | | |
| 2 | .336 8.53 | 1.72 | .655 | .335 | 1/4 | 1526491-1 | 1526491-2 |
| | | 43.69 | 16.65 | 8.51 | 5/16 | 1526597-1 | 1526597-2 |
| | | | | | 3/8 | 1526705-1 | 1526705-2 |
| | | | | | 3/8 | 1526453-1 | 1526453-2 |
| | | | | | 3/8 | 1526466-1 | 1526466-2 |
| | | | | | 1/2 | 1526480-1 | 1526480-2 |
| | | | | 1/4 | 1526491-1 | 1526491-2 | |
| | | | | 5/16 | 1526597-1 | 1526597-2 | |
| | | | | 3/8 | 1526705-1 | 1526705-2 | |
| | | | | 1/2 | 1526714-1 | 1526714-2 | |
| | | | | 3/8 | 1526720-1 | 1526720-2 | |
| | | | | 1/2 | 1526732-1 | 1526732-2 | |
| 1/0 | .407 10.33 | 1.83 | .725 | .385 | 1/4 | 1526491-1 | 1526491-2 |
| | | 46.48 | 18.41 | 9.78 | 5/16 | 1526597-1 | 1526597-2 |
| | | | | | 3/8 | 1526705-1 | 1526705-2 |
| | | | | | 1/2 | 1526714-1 | 1526714-2 |
| | | | | | 3/8 | 1526720-1 | 1526720-2 |
| | | | | | 1/2 | 1526732-1 | 1526732-2 |
| | | | | 1/4 | 1526491-1 | 1526491-2 | |
| | | | | 5/16 | 1526597-1 | 1526597-2 | |
| | | | | 3/8 | 1526705-1 | 1526705-2 | |
| | | | | 1/2 | 1526714-1 | 1526714-2 | |
| | | | | 3/8 | 1526720-1 | 1526720-2 | |
| | | | | 1/2 | 1526732-1 | 1526732-2 | |

Heavy Duty Seamless Lugs and Splices (Continued)

Seamless Ring Lugs with Sight Holes (Continued)

Wire Size Range
2/0 AWG to 250 MCM

Material

Terminal Body — Copper per ASTM B-152

Plating — Tin per ASTM B-545

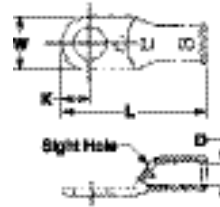

| Wire Size | Dimensions | | | | Stud Size | Part Numbers | | | | |
|-----------|---------------|---------------|---------------|---------------|---------------|----------------|---------------|---------------|-----------|-----------|
| | D | L | W | K | | Plain Copper | Tin Plated | | | |
| 2/0 | .461 11.71 | 2.06 52.37 | .815 20.70 | .425 10.80 | 1/4 | 1526739-1 | 1526739-2 | | | |
| | | | | | 5/16 | 1526746-1 | 1526746-2 | | | |
| | 3/8 | 1526759-1 | 1526759-2 | 1/2 | 1526782-1 | 1526782-2 | | | | |
| | 1/4 | — | 1526794-2 | 3/0 | .511 12.98 | 2.16 54.86 | .895 22.73 | .465 11.81 | 5/16 | 1526800-1 |
| 3/8 | 1526806-1 | 1526806-2 | | | | | | | | |
| 1/2 | 1526820-1 | 1526820-2 | 1/4 | | 1526831-1 | 1526831-2 | | | | |
| 5/16 | — | 1526838-2 | 4/0 | | .559 14.20 | 2.35 59.69 | .985 25.02 | .505 12.83 | 3/8 | — |
| 1/2 | 1526853-1 | 1526853-2 | | | | | | | | |
| 3/8 | 1526862-1 | 1526862-2 | | .590 14.99 | 2.39 60.71 | 1.035 26.29 | .525 13.34 | 1/2 | 1526874-1 | 1526874-2 |
| 5/8 | 1526884-1 | 1526884-2 | | | | | | | | |
| 3/8 | 1526893-1 | 1526893-2 | | .625 15.87 | 2.46 62.68 | 1.085 27.56 | .555 14.10 | 1/2 | 1526912-1 | 1526912-2 |
| 5/8 | 1526923-1 | 1526923-2 | | | | | | | | |
| 250 MCM | .685 17.40 | 2.65 67.46 | 1.20 30.55 | .605 15.37 | 3/8 | 1526929-1 | 1526929-2 | | | |

Heavy Duty Seamless Lugs and Splices (Continued)

Seamless Angled Ring Lugs

Wire Size Range
8 AWG to 1

Material

Terminal Body — Copper per
ASTM B-152

Plating — Tin per ASTM B-545

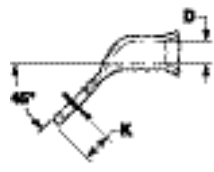

45° Bend



90° Bend



| Wire Size | Dimensions | | | Stud Size | Angle | Part Numbers | |
|-----------|--------------|---------------|---------------|-----------|-----------|--------------|------------|
| | D | W | K | | | Plain Copper | Tin Plated |
| 8 | .185 4.70 | .445 11.30 | .235 5.97 | 10 | 45° | 1526111-1 | 1526111-2 |
| | | | | 1/4 | 45° | 1526117-1 | 1526117-2 |
| | | | | 1/4 | 90° | 1526118-1 | 1526118-2 |
| | .232 5.89 | .765 19.45 | .395 10.03 | 1/2 | 90° | 1526157-1 | 1526157-2 |
| | | | | 5/16 | 90° | 1526163-1 | 1526163-2 |
| | | | | | 45° | 1526168-1 | 1526168-2 |
| 6 | .286 7.26 | .605 15.37 | .315 8.00 | 3/8 | 90° | 1526190-1 | 1526190-2 |
| | | | | 1/2 | 90° | 1526196-1 | 1526196-2 |
| | | | | | 90° | 1526220-1 | 1526220-2 |
| | .286 7.26 | .525 13.34 | .275 6.99 | 1/4 | 90° | 1526232-1 | 1526232-2 |
| | | | | 5/16 | 45° | 1526237-1 | 1526237-2 |
| | | | | 3/8 | 90° | 1526245-1 | — |
| 4 | .286 7.26 | .625 15.88 | .325 8.26 | 5/16 | 45° | 1526253-1 | — |
| | | | | 3/8 | 45° | — | 1526272-2 |
| | | | | | 90° | — | 1526273-2 |
| | .336 8.53 | .765 19.45 | .395 10.03 | 1/2 | 45° | — | 1526284-2 |
| | | | | 1/2 | 90° | — | 1526285-2 |
| | | | | | 90° | 1526293-1 | 1526293-2 |
| 2 | .336 8.53 | .615 15.62 | .325 8.25 | 1/4 | 90° | 1526293-1 | 1526293-2 |
| | | | | 5/16 | 45° | 1526399-1 | — |
| | | | | | 90° | 1526400-1 | 1526400-2 |
| | .360 9.14 | .755 19.18 | .395 10.03 | 3/8 | 90° | 1526408-1 | — |
| | | | | 1/2 | 90° | 1526434-1 | 1526434-2 |
| | | | | | 90° | — | 1526445-2 |
| 1 | .360 9.14 | .655 16.64 | .335 8.51 | 5/16 | 90° | — | 1526445-2 |
| | | | | 3/8 | 45° | — | 1526454-2 |
| | 1/2 | 90° | 1526455-1 | | 1526455-2 | | |
| | | 1/2 | 45° | — | 1526486-2 | | |
| 1/2 | 90° | — | 1526487-2 | | | | |

Heavy Duty Seamless Lugs and Splices (Continued)

Seamless Angled Ring Lugs

(Continued)

Wire Size Range
1/0 AWG to 250 MCM

Material

Terminal Body — Copper per ASTM B-152

Plating — Tin per ASTM B-545

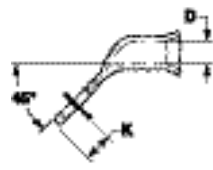

45° Bend



90° Bend



| Wire Size | Dimensions | | | Stud Size | Angle | Part Numbers | | | | | |
|-----------|---------------|---------------|---------------|-----------|---------------|---------------|---------------|---------------|-----|-----------|-----------|
| | D | W | K | | | Plain Copper | Tin Plated | | | | |
| 1/0 | .407 10.33 | .725 18.42 | .385 9.78 | 3/8 | 45° | 1526706-1 | 1526706-2 | | | | |
| | | | | | 90° | 1526707-1 | 1526707-2 | | | | |
| | 1/2 | 45° | — | 1526715-2 | | | | | | | |
| | | 90° | 1526716-1 | 1526716-2 | | | | | | | |
| 2/0 | .461 11.71 | .815 20.70 | .425 10.80 | 5/16 | 45° | — | 1526747-2 | | | | |
| | | | | 3/8 | 45° | 1526764-1 | 1526764-2 | | | | |
| | | | | | 90° | 1526769-1 | 1526769-2 | | | | |
| | | | | 1/2 | 45° | 1526783-1 | 1526783-2 | | | | |
| | | | | | 90° | 1526784-1 | 1526784-2 | | | | |
| | | | | 3/0 | .511 12.98 | .895 22.73 | .465 11.81 | 1/4 | 90° | — | 1526796-2 |
| 3/8 | 45° | 1526809-1 | — | | | | | | | | |
| | 90° | 1526810-1 | 1526810-2 | | | | | | | | |
| 1/2 | 90° | 1526822-1 | 1526822-2 | | | | | | | | |
| | 3/8 | 45° | — | | | | | 1526848-2 | | | |
| 1/2 | | 90° | 1526849-1 | | | | | 1526849-2 | | | |
| | 4/0 | .559 14.20 | .985 25.02 | | | | | .505 12.83 | 1/2 | 45° | 1526854-1 |
| 90° | | | | | | | | | | 1526856-1 | 1526856-2 |
| 1/2 | | | | 90° | — | 1526878-2 | | | | | |
| | | | | 3/8 | 45° | 1526896-1 | 1526897-2 | | | | |
| 1/2 | | | | | 45° | 1526913-1 | — | | | | |
| | | | | 90° | 1526914-1 | 1526914-2 | | | | | |
| 250 MCM | .685 17.40 | 1.20 30.55 | .605 15.37 | 1/2 | 90° | — | 1526937-2 | | | | |

Heavy Duty Seamless Lugs and Splices (Continued)

Seamless Angled Ring Lugs with Sight Holes

Wire Size Range
8 AWG to 1/0

Material

Terminal Body — Copper per ASTM B-152

Plating — Tin per ASTM B-545

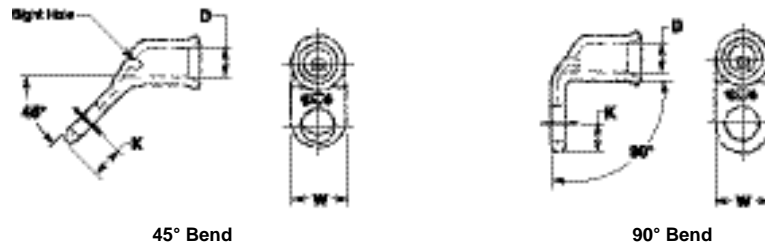

| Wire Size | Dimensions | | | Stud Size | Angle | Part Numbers | | | | |
|-----------|------------|-------|-------|-----------|-------|--------------|------------|-------|-------|-----------|
| | D | W | K | | | Plain Copper | Tin Plated | | | |
| 8 | .185 | .765 | .395 | 1/2 | 90° | 1526159-1 | 1526159-2 | | | |
| | 4.70 | 19.45 | 10.03 | | | | | | | |
| 6 | .232 | .445 | .235 | 1/4 | 45° | 1526170-1 | 1526170-2 | | | |
| | 5.89 | 11.30 | 5.97 | | | | | | | |
| 4 | .286 | 7.26 | .525 | 1/4 | 90° | — | 1526234-2 | | | |
| | | | 13.34 | | | | | 6.99 | | |
| | | | .625 | 3/8 | 45° | 1526262-1 | — | | | |
| | | | 15.88 | | | | | 8.26 | | |
| | | | .765 | 1/2 | 90° | — | 1526287-2 | | | |
| | | | 19.45 | | | | | 10.03 | | |
| 2 | .336 | 8.53 | .615 | 1/4 | 90° | — | 1526295-2 | | | |
| | | | 15.62 | | | | | 8.26 | | |
| | | | .755 | 3/8 | 45° | 1526423-1 | — | | | |
| | | | 19.18 | | | | | 10.03 | | |
| | | | .360 | 1/2 | 90° | 1526436-1 | 1526436-2 | | | |
| | | | 9.14 | | | | | 16.64 | 8.51 | |
| 1 | .360 | 9.14 | .655 | 1/4 | 90° | 1526442-1 | 1526442-2 | | | |
| | | | 16.64 | | | | | 8.51 | | |
| | | | .725 | 3/8 | 90° | — | 1526447-2 | | | |
| | | | 18.42 | | | | | 9.78 | | |
| | | | 1/0 | .407 | 10.33 | .385 | 5/16 | 90° | — | 1526701-2 |
| | | | | | | 9.78 | | | | |
| .825 | 3/8 | 45° | | | | 1526708-1 | — | | | |
| 20.96 | | | | | | | | 10.80 | | |
| .425 | 1/2 | 90° | | | | 1526726-1 | — | | | |
| 10.80 | | | | | | | | | | |
| 2/0 | .461 | 11.71 | .825 | 3/8 | 90° | 1526727-1 | — | | | |
| | | | 20.96 | | | | | 10.80 | | |
| | | | .425 | 1/2 | 45° | 1526735-1 | — | | | |
| | | | 10.80 | | | | | | | |
| | | | .825 | 5/16 | 90° | 1526736-1 | — | | | |
| | | | 20.96 | | | | | | | |
| 3/0 | .511 | 12.98 | .895 | 1/4 | 90° | 1526743-1 | 1526743-2 | | | |
| | | | 22.73 | | | | | 11.81 | | |
| | | | .465 | 3/8 | 90° | 1526751-1 | 1526751-2 | | | |
| | | | 11.81 | | | | | | | |
| | | | .559 | 1/2 | 45° | 1526770-1 | — | | | |
| | | | 14.20 | | | | | 25.02 | 12.83 | |
| 4/0 | .590 | 14.99 | 1.035 | 3/8 | 45° | 1526772-1 | — | | | |
| | | | 26.29 | | | | | 13.34 | | |
| | | | .525 | 1/2 | 90° | 1526786-1 | — | | | |
| | | | 13.34 | | | | | | | |
| | | | .625 | 3/8 | 45° | 1526788-1 | — | | | |
| | | | 15.87 | | | | | 27.56 | 14.10 | |
| 250 MCM | .685 | 17.40 | 1.20 | 5/8 | 90° | 1526804-1 | — | | | |
| | | | 30.55 | | | | | 15.08 | | |
| 250 MCM | .593 | 15.08 | .593 | 3/8 | 45° | 1526813-1 | — | | | |
| | | | 15.08 | | | | | | | |
| 250 MCM | .593 | 15.08 | .555 | 1/2 | 90° | 1526824-1 | — | | | |
| | | | 15.08 | | | | | | | |
| 250 MCM | .593 | 15.08 | .555 | 3/8 | 45° | 1526857-1 | — | | | |
| | | | 15.08 | | | | | | | |
| 250 MCM | .593 | 15.08 | .555 | 1/2 | 90° | 1526868-1 | — | | | |
| | | | 15.08 | | | | | | | |
| 250 MCM | .593 | 15.08 | .555 | 3/8 | 45° | 1526879-1 | — | | | |
| | | | 15.08 | | | | | | | |
| 250 MCM | .593 | 15.08 | .555 | 1/2 | 90° | 1526880-1 | — | | | |
| | | | 15.08 | | | | | | | |
| 250 MCM | .593 | 15.08 | .555 | 3/8 | 45° | 1526899-1 | 1526899-2 | | | |
| | | | 15.08 | | | | | | | |
| 250 MCM | .593 | 15.08 | .555 | 1/2 | 90° | 1526901-1 | 1526901-2 | | | |
| | | | 15.08 | | | | | | | |
| 250 MCM | .593 | 15.08 | .555 | 3/8 | 45° | 1526916-1 | — | | | |
| | | | 15.08 | | | | | | | |
| 250 MCM | .593 | 15.08 | .555 | 1/2 | 90° | 1526918-1 | 1526918-2 | | | |
| | | | 15.08 | | | | | | | |
| 250 MCM | .593 | 15.08 | .555 | 3/8 | 45° | 1526945-1 | 1526945-2 | | | |
| | | | 15.08 | | | | | | | |
| 250 MCM | .593 | 15.08 | .555 | 1/2 | 90° | 1526946-1 | 1526946-2 | | | |
| | | | 15.08 | | | | | | | |

Heavy Duty Seamless Lugs and Splices (Continued)

Seamless Butt Splices

Wire Size Range
8 AWG to 4/0

Material

Terminal Body — Copper per
ASTM B-152

Plating — Tin per ASTM B-545

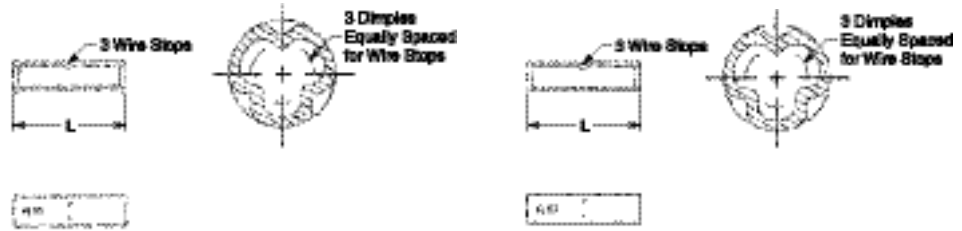

Flared Ends

| Wire Size | Barrel I.D. | Dim. L Max. | Part Number Tin Plated |
|-----------|---------------|----------------|------------------------|
| 8 | .170 4.32 | .990 25.15 | 1526961-2 |
| 6 | .232 5.89 | 1.090 27.69 | 1526962-2 |
| 4 | .286 7.26 | 1.230 31.24 | 1526963-2 |
| 2 | .336 8.53 | 1.380 35.05 | 1526965-2 |
| 1 | .360 9.14 | 1.380 35.05 | 1526966-2 |
| 1/0 | .407 10.33 | 1.580 40.13 | 1526967-2 |
| 2/0 | .461 11.71 | 1.830 46.48 | 1526968-2 |
| 3/0 | .511 12.98 | 1.930 49.02 | 1526969-2 |
| 4/0 | .559 14.20 | 2.030 51.56 | 1526970-2 |
| | .590 14.99 | 2.030 51.56 | 1526971-2 |
| | .625 15.88 | 2.030 51.56 | 1526972-2 |

Chamfered Ends

| Wire Size | Barrel I.D. | Dim. L Max. | Part Number Tin Plated |
|-----------|---------------|----------------|------------------------|
| 8 | .170 4.32 | .990 25.15 | 1526979-2 |
| 6 | .232 5.89 | 1.090 27.69 | 1526980-2 |
| 4 | .286 7.26 | 1.230 31.24 | 1526981-2 |
| 2 | .336 8.53 | 1.380 35.05 | 1526982-2 |
| 1 | .360 9.14 | 1.380 35.05 | 1526983-2 |
| 1/0 | .407 10.33 | 1.580 40.13 | 1526984-2 |
| 2/0 | .461 11.71 | 1.830 46.48 | 1526985-2 |
| 4/0 | .559 14.20 | 2.030 51.56 | 1526987-2 |
| | .625 15.88 | 2.030 51.56 | 1526989-2 |

Industrial Electrical Lugs and Splices

Industrial Lugs
ETP Copper, Color Coded,
Tin-Plated, Sight Hole,
Flared Ends
Wire Size Range
8 AWG to 4/0

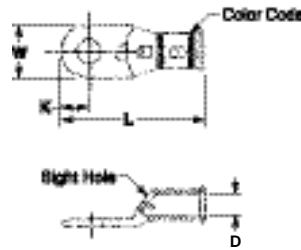

Material

Terminal Body — Copper per ASTM B-152

Plating — Tin per ASTM B-545

| AWG | Color Code | Dimensions | | | | Stud Size | Part Number | |
|-----|------------|------------|-------|-------|-------|-----------|-------------|-----------|
| | | D | L | W | K | | | |
| 8 | Red | .186 | 1.200 | .445 | .235 | 10 | 1527115-3 | |
| | | 4.72 | 30.48 | 11.30 | 5.97 | 1/4 | 1527117-3 | |
| | | .186 | 1.305 | .605 | .315 | 1/4 | 1527119-3 | |
| | | 4.72 | 33.15 | 15.37 | 8.00 | 5/16 | 1527120-3 | |
| | | .186 | 1.480 | .765 | .395 | 3/8 | 1527121-3 | |
| | | 4.72 | 37.59 | 19.43 | 10.03 | 3/8 | 1527122-3 | |
| | 6 | Blue | .232 | 1.270 | .445 | .235 | 1/2 | 1527123-3 |
| | | | 5.89 | 32.26 | 11.30 | 5.97 | 10 | 1527124-3 |
| | | | .232 | 1.410 | .605 | .315 | 1/4 | 1527125-3 |
| | | | 5.89 | 35.81 | 15.37 | 8.00 | 1/4 | 1527126-3 |
| | | | .232 | 1.550 | .765 | .395 | 5/16 | 1527127-3 |
| | | | 5.89 | 39.37 | 19.43 | 10.03 | 3/8 | 1527128-3 |
| 4 | Grey | .286 | 1.500 | .525 | .275 | 1/2 | 1527129-3 | |
| | | 7.26 | 38.10 | 13.34 | 6.99 | 10 | 1527130-3 | |
| | | .286 | 1.530 | .625 | .325 | 1/4 | 1527131-3 | |
| | | 7.26 | 38.86 | 15.88 | 8.26 | 1/4 | 1527132-3 | |
| | | .286 | 1.680 | .765 | .395 | 5/16 | 1527133-3 | |
| | | 7.26 | 42.67 | 19.43 | 10.03 | 3/8 | 1527134-3 | |
| 2 | Brown | .336 | 1.620 | .615 | .325 | 1/2 | 1527135-3 | |
| | | 8.53 | 41.15 | 15.62 | 8.26 | 10 | 1527136-3 | |
| | | .336 | 1.750 | .755 | .395 | 1/4 | 1527137-3 | |
| | | 8.53 | 44.45 | 19.18 | 10.03 | 1/4 | 1527138-3 | |
| | | .336 | 1.830 | .825 | .425 | 5/16 | 1527139-3 | |
| | | 8.53 | 46.48 | 20.96 | 10.80 | 3/8 | 1527140-3 | |
| 1 | Green | .407 | 1.830 | .725 | .385 | 3/8 | 1527141-3 | |
| | | 10.34 | 46.48 | 18.42 | 9.78 | 1/2 | 1527142-3 | |
| | | .407 | 1.900 | .825 | .425 | 1/4 | 1527143-3 | |
| | | 10.34 | 48.26 | 20.96 | 10.80 | 5/16 | 1527096-3 | |
| | | .407 | 1.830 | .725 | .385 | 3/8 | 1527146-3 | |
| | | 10.34 | 46.48 | 18.42 | 9.78 | 1/2 | 1527147-3 | |
| 1/0 | Pink | .461 | 2.060 | .815 | .425 | 1/2 | 1527148-3 | |
| | | 11.71 | 52.32 | 20.70 | 10.80 | 1/4 | 1527149-3 | |
| | | .461 | 2.160 | .895 | .465 | 5/16 | 1527150-3 | |
| | | 11.71 | 54.86 | 22.73 | 11.81 | 3/8 | 1527151-3 | |
| | | .461 | 2.350 | .985 | .505 | 1/2 | 1527152-3 | |
| | | 11.71 | 59.69 | 25.02 | 12.83 | 1/4 | 1527153-3 | |
| 2/0 | Black | .511 | 2.160 | .895 | .465 | 1/2 | 1527154-3 | |
| | | 12.98 | 54.86 | 22.73 | 11.81 | 1/4 | 1527155-3 | |
| | | .511 | 2.350 | .985 | .505 | 5/16 | 1527156-3 | |
| | | 12.98 | 59.69 | 25.02 | 12.83 | 3/8 | 1527157-3 | |
| | | .511 | 2.500 | 1.065 | .545 | 1/2 | 1527158-3 | |
| | | 12.98 | 63.50 | 27.06 | 13.91 | 1/4 | 1527159-3 | |
| 3/0 | Orange | .559 | 2.350 | .985 | .505 | 5/16 | 1527160-3 | |
| | | 14.20 | 59.69 | 25.02 | 12.83 | 3/8 | 1527161-3 | |
| | | .559 | 2.500 | 1.065 | .545 | 1/2 | 1527162-3 | |
| | | 14.20 | 63.50 | 27.06 | 13.91 | 1/4 | 1527163-3 | |
| | | .559 | 2.650 | 1.145 | .585 | 5/16 | 1527164-3 | |
| | | 14.20 | 67.61 | 29.31 | 14.96 | 3/8 | 1527165-3 | |
| 4/0 | Purple | .559 | 2.350 | .985 | .505 | 1/2 | 1527166-3 | |
| | | 14.20 | 59.69 | 25.02 | 12.83 | 1/2 | 1527166-3 | |

Industrial Electrical Lugs and Splices (Continued)

Industrial Butt Splices

Wire Size Range
8 AWG to 4/0

Material

Terminal Body — Copper per
ASTM B-75

Plating — Tin per ASTM B-545

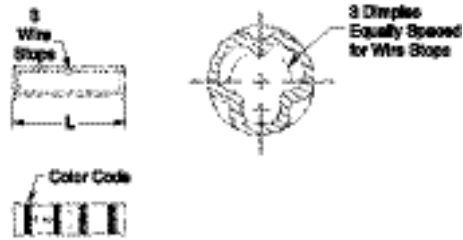

| AWG | Color Code | Barrel I.D. | Dim. L Max. | Part Number |
|-----|------------|---------------|----------------|-------------|
| 8 | Red | .170 4.32 | .990 25.15 | 1526990-3 |
| 6 | Blue | .232 5.89 | 1.090 27.69 | 1526991-3 |
| 4 | Grey | .286 7.26 | 1.230 31.24 | 1526992-3 |
| 2 | Brown | .336 9.14 | 1.380 35.05 | 1526993-3 |
| 1 | Green | .360 9.14 | 1.380 35.05 | 1526994-3 |
| 1/0 | Pink | .407 10.34 | 1.580 40.13 | 1526995-3 |
| 2/0 | Black | .461 11.71 | 1.830 46.48 | 1526996-3 |
| 3/0 | Orange | .511 12.98 | 1.930 49.02 | 1526997-3 |
| 4/0 | Purple | .559 14.20 | 2.030 51.56 | 1526998-3 |

Copper Compression Lugs and Splices

Standard Barrel Lug with One Stud Hole

Wire Size Range
8 AWG to 500 MCM

Material

Terminal Body — Copper per ASTM B-75

Plating — Tin per ASTM B-545

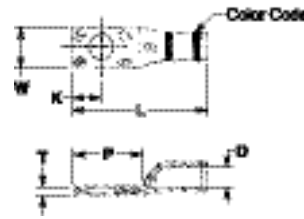

| AWG | Color Code | Dimensions | | | | | | Stud Size | Part Number |
|---------|------------|------------|-------|-------|-------|-------|------|-----------|-------------|
| | | D | L | W | K | P | T | | |
| 8 | Red | .170 | 1.150 | .350 | .250 | .595 | .078 | 10 | 1527208-3 |
| | | 4.32 | 29.21 | 8.89 | 6.35 | 15.11 | 1.98 | | |
| | | .170 | 1.150 | .460 | .250 | .595 | .078 | 1/4 | 1527209-3 |
| | | 4.32 | 29.21 | 11.68 | 6.35 | 15.11 | 1.98 | | |
| 6 | Blue | .204 | 1.230 | .400 | .250 | .625 | .078 | 10 | 1527210-3 |
| | | 5.18 | 31.24 | 10.16 | 6.35 | 15.87 | 1.98 | 1/4 | 1527211-3 |
| | | .204 | 1.230 | .530 | .250 | .625 | .078 | 5/16 | 1527214-3 |
| | | 5.18 | 31.24 | 13.46 | 6.35 | 15.87 | 1.98 | | |
| 4 | Grey | .252 | 1.410 | .500 | .300 | .725 | .108 | 10 | 1527215-3 |
| | | 6.40 | 35.81 | 12.70 | 7.62 | 18.42 | 2.74 | 1/4 | 1527216-3 |
| | | .252 | 1.410 | .640 | .300 | .725 | .108 | 5/16 | 1527217-3 |
| | | 6.40 | 35.81 | 16.26 | 7.62 | 18.42 | 2.74 | | |
| | | .252 | 1.410 | .500 | .300 | .725 | .108 | 3/8 | 1527219-3 |
| | | 6.40 | 35.81 | 12.70 | 7.62 | 18.42 | 2.74 | | |
| 2 | Brown | .312 | 1.580 | .610 | .350 | .825 | .124 | 1/4 | 1527220-3 |
| | | 7.92 | 40.13 | 15.49 | 8.89 | 20.96 | 3.15 | 5/16 | 1527221-3 |
| | | | | | | | | 3/8 | 1527222-3 |
| | | | | | | | | 1/4 | 1527225-3 |
| 1 | Green | .352 | 1.850 | .690 | .400 | .975 | .134 | 5/16 | 1527226-3 |
| | | 8.94 | 46.99 | 17.52 | 10.16 | 24.77 | 3.40 | 3/8 | 1527227-3 |
| | | | | | | | | 1/2 | 1527228-3 |
| | | | | | | | | 1/4 | 1527229-3 |
| 1/0 | Pink | .393 | 2.010 | .760 | .450 | 1.025 | .140 | 5/16 | 1527230-3 |
| | | 9.98 | 51.05 | 19.30 | 11.43 | 26.04 | 3.56 | 3/8 | 1527231-3 |
| | | | | | | | | 1/2 | 1527232-3 |
| | | | | | | | | 1/4 | 1527233-3 |
| 2/0 | Black | .443 | 2.120 | .830 | .450 | 1.025 | .140 | 5/16 | 1527234-3 |
| | | 11.25 | 53.85 | 21.08 | 11.43 | 26.04 | 3.56 | 3/8 | 1527235-3 |
| | | | | | | | | 1/2 | 1527237-3 |
| | | | | | | | | 1/4 | 1527238-3 |
| 3/0 | Orange | .490 | 2.250 | .910 | .450 | 1.025 | .140 | 5/16 | 1527240-3 |
| | | 12.44 | 57.15 | 23.11 | 11.43 | 26.04 | 3.56 | 3/8 | 1527242-3 |
| | | | | | | | | 1/2 | 1527243-3 |
| | | | | | | | | 1/4 | 1527244-3 |
| 4/0 | Purple | .548 | 2.330 | 1.020 | .450 | 1.025 | .155 | 3/8 | 1527247-3 |
| | | 13.92 | 59.18 | 25.91 | 11.43 | 26.04 | 3.96 | 1/2 | 1527249-3 |
| 250 MCM | Yellow | .600 | 2.610 | 1.140 | .500 | 1.165 | .186 | 3/8 | 1527251-3 |
| | | 15.24 | 66.29 | 28.97 | 12.70 | 29.59 | 4.72 | 1/2 | 1527253-3 |
| | | | | | | | | 3/8 | 1527255-3 |
| | | | | | | | | 1/2 | 1527256-3 |
| 300 MCM | White | .660 | 2.800 | 1.220 | .550 | 1.235 | .186 | 5/8 | 1527258-3 |
| | | 16.76 | 71.12 | 30.99 | 13.97 | 31.37 | 4.72 | 3/8 | 1527259-3 |
| 350 MCM | Red | .711 | 2.980 | 1.320 | .550 | 1.275 | .202 | 1/2 | 1527260-3 |
| | | 18.06 | 75.69 | 33.52 | 13.97 | 32.39 | 5.13 | 5/8 | 1527261-3 |
| 400 MCM | Blue | .758 | 3.100 | 1.400 | .550 | 1.305 | .218 | 3/8 | 1527266-3 |
| | | 19.25 | 78.74 | 35.56 | 13.97 | 33.15 | 5.54 | 1/2 | 1527263-3 |
| 500 MCM | Brown | .843 | 3.350 | 1.580 | .550 | 1.325 | .250 | 3/8 | 1527267-3 |
| | | 21.41 | 85.09 | 40.13 | 13.97 | 33.66 | 6.35 | 1/2 | 1527268-3 |
| | | | | | | | 5/8 | 1527270-3 | |

Copper Compression Lugs and Splices (Continued)

Standard Barrel Lug with Two Stud Holes

Wire Size Range
8 AWG to 500 MCM

Material

Terminal Body — Copper per ASTM B-75

Plating — Tin per ASTM B-545

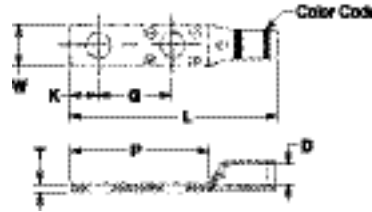

| AWG | Color Code | Dimensions | | | | | | | Stud Size | Part Number |
|---------|------------|------------|--------|-------|-------|-------|-------|------|-----------|-------------|
| | | D | L | W | K | P | G | T | | |
| 8 | Red | .170 | 1.740 | .350 | .250 | 1.185 | .625 | .078 | 10 | 1527272-3 |
| | | 4.32 | 44.20 | 8.89 | 6.35 | 30.10 | 15.88 | 1.98 | | |
| 6 | Blue | .204 | 1.900 | .400 | .250 | 1.295 | .625 | .078 | 1/4 | 1527273-3 |
| | | 5.18 | 48.26 | 10.16 | 6.35 | 32.89 | 15.88 | 1.98 | | |
| 4 | Grey | .252 | 2.000 | .500 | .300 | 1.315 | .625 | .108 | 1/4 | 1527277-3 |
| | | 6.40 | 50.80 | 12.70 | 7.62 | 33.40 | 15.88 | 2.74 | | 1527278-3 |
| | | .312 | 2.100 | .610 | .300 | 1.345 | .625 | .124 | 5/16 | 1527279-3 |
| | | 7.92 | 53.34 | 15.49 | 7.62 | 34.16 | 15.88 | 3.15 | | 1527280-3 |
| 2 | Brown | .312 | 2.200 | .610 | .300 | 1.465 | .750 | .124 | 5/16 | 1527280-3 |
| | | 7.92 | 55.88 | 15.49 | 7.62 | 37.21 | 19.05 | 3.15 | | |
| 1 | Green | .352 | 2.250 | .690 | .300 | 1.375 | .625 | .134 | 1/4 | 1527281-3 |
| | | 8.94 | 57.15 | 17.53 | 7.62 | 34.93 | 15.88 | 3.40 | | |
| 1/0 | Pink | .352 | 2.375 | .690 | .300 | 1.495 | .750 | .134 | 5/16 | 1527283-3 |
| | | 8.94 | 60.33 | 17.53 | 7.62 | 37.97 | 19.05 | 3.40 | | |
| 1/0 | Pink | .393 | 2.680 | .760 | .350 | 1.695 | .875 | .140 | 5/16 | 1527284-3 |
| | | 9.98 | 68.07 | 19.30 | 8.89 | 43.05 | 22.23 | 3.56 | | |
| 2/0 | Black | .393 | 2.900 | .760 | .400 | 1.915 | 1.000 | .140 | 3/8 | 1527285-3 |
| | | 9.98 | 73.66 | 19.30 | 10.16 | 48.64 | 25.40 | 3.56 | | |
| 2/0 | Black | .443 | 2.900 | .830 | .350 | 1.805 | 1.000 | .140 | 5/16 | 1527286-3 |
| | | 11.25 | 73.66 | 21.08 | 8.89 | 45.85 | 25.40 | 3.56 | | 1527287-3 |
| 2/0 | Black | .443 | 3.800 | .830 | .450 | 2.705 | 1.750 | .140 | 1/2 | 1527288-3 |
| | | 11.25 | 96.52 | 21.08 | 11.43 | 68.71 | 44.45 | 3.56 | | |
| 3/0 | Orange | .490 | 3.200 | .910 | .450 | 1.975 | 1.000 | .140 | 3/8 | 1527291-3 |
| | | 12.45 | 81.28 | 23.11 | 11.43 | 50.17 | 25.40 | 3.56 | | |
| 3/0 | Orange | .490 | 3.950 | .910 | .450 | 2.725 | 1.750 | .140 | 1/2 | 1527293-3 |
| | | 12.45 | 100.33 | 23.11 | 11.43 | 69.22 | 44.45 | 3.56 | | |
| 4/0 | Purple | .548 | 3.330 | 1.020 | .450 | 1.975 | 1.000 | .156 | 3/8 | 1527294-3 |
| | | 13.92 | 84.58 | 25.91 | 11.43 | 50.17 | 25.40 | 3.96 | | |
| 4/0 | Purple | .548 | 4.120 | 1.020 | .450 | 2.765 | 1.750 | .156 | 1/2 | 1527296-3 |
| | | 13.92 | 104.65 | 25.91 | 11.43 | 70.23 | 44.45 | 3.96 | | |
| 250 MCM | Yellow | .600 | 3.420 | 1.140 | .450 | 1.975 | 1.000 | .186 | 3/8 | 1527297-3 |
| | | 15.24 | 86.87 | 28.96 | 11.43 | 50.17 | 25.40 | 4.72 | | |
| 250 MCM | Yellow | .600 | 4.250 | 1.140 | .500 | 2.805 | 1.750 | .186 | 1/2 | 1527298-3 |
| | | 15.24 | 107.95 | 28.96 | 12.70 | 71.25 | 44.45 | 4.72 | | |
| 300 MCM | White | .660 | 3.600 | 1.220 | .450 | 2.035 | 1.000 | .186 | 3/8 | 1527300-3 |
| | | 16.76 | 91.44 | 30.99 | 11.43 | 51.69 | 25.40 | 4.72 | | |
| 300 MCM | White | .660 | 4.400 | 1.220 | .500 | 2.835 | 1.750 | .186 | 1/2 | 1527301-3 |
| | | 16.76 | 111.76 | 30.99 | 12.70 | 72.01 | 44.45 | 4.72 | | |
| 350 MCM | Red | .711 | 3.700 | 1.320 | .450 | 1.995 | 1.000 | .202 | 3/8 | 1527302-3 |
| | | 18.06 | 93.98 | 33.53 | 11.43 | 50.67 | 25.40 | 5.13 | | |
| 350 MCM | Red | .711 | 4.550 | 1.320 | .500 | 2.845 | 1.750 | .202 | 1/2 | 1527303-3 |
| | | 18.06 | 115.57 | 33.53 | 12.70 | 72.26 | 44.45 | 5.13 | | |
| 400 MCM | Blue | .758 | 3.800 | 1.400 | .450 | 2.005 | 1.000 | .218 | 3/8 | 1527304-3 |
| | | 19.25 | 96.52 | 35.56 | 11.43 | 50.93 | 25.40 | 5.54 | | |
| 400 MCM | Blue | .758 | 4.650 | 1.400 | .500 | 2.855 | 1.750 | .218 | 1/2 | 1527305-3 |
| | | 19.25 | 118.11 | 35.56 | 12.70 | 72.52 | 44.45 | 5.54 | | |
| 500 MCM | Brown | .843 | 4.050 | 1.580 | .450 | 2.025 | 1.000 | .250 | 3/8 | 1527306-3 |
| | | 21.41 | 102.87 | 40.13 | 11.43 | 51.44 | 25.40 | 6.35 | | |
| 500 MCM | Brown | .843 | 4.900 | 1.580 | .500 | 2.815 | 1.750 | .250 | 1/2 | 1527307-3 |
| | | 21.41 | 124.46 | 40.13 | 12.70 | 73.03 | 44.45 | 6.35 | | |

Copper Compression Lugs and Splices (Continued)

Long Barrel Lug with One Stud Hole

Wire Size Range
8 AWG to 500 MCM

Material

Terminal Body — Copper per ASTM B-75

Plating — Tin per ASTM B-545

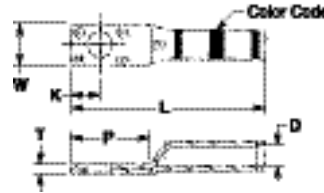

| AWG | Color Code | Dimensions | | | | | | Stud Size | Part Number |
|---------|------------|------------|--------|-------|-------|-------|------|-----------|-------------|
| | | D | L | W | K | P | T | | |
| 8 | Red | .170 | 1.650 | .350 | .250 | .685 | .078 | 10 | 1527309-3 |
| | | 4.32 | 41.91 | 8.89 | 6.35 | 17.40 | 1.98 | | |
| 6 | Blue | .204 | 1.700 | .400 | .250 | .685 | .078 | 1/4 | 1527311-3 |
| | | 5.18 | 43.18 | 10.16 | 6.35 | 17.39 | 1.98 | | |
| 4 | Grey | .252 | 1.750 | .500 | .300 | .735 | .108 | 1/4 | 1527313-3 |
| | | 6.40 | 41.45 | 12.70 | 7.62 | 18.67 | 2.74 | | |
| 2 | Brown | .312 | 2.060 | .610 | .350 | .825 | .124 | 1/4 | 1527317-3 |
| | | 7.92 | 52.32 | 15.49 | 8.89 | 20.96 | 3.15 | 5/16 | 1527318-3 |
| | | | | | | | | 3/8 | 1527315-3 |
| 1 | Green | .352 | 2.160 | .690 | .350 | .845 | .134 | 1/4 | 1527320-3 |
| | | 8.94 | 54.86 | 17.53 | 8.89 | 21.46 | 3.40 | 5/16 | 1527321-3 |
| | | | | | | | | 3/8 | 1527319-3 |
| 1/0 | Pink | .393 | 2.350 | .760 | .400 | .965 | .140 | 5/16 | 1527322-3 |
| | | 9.98 | 59.69 | 19.30 | 10.16 | 24.51 | 3.56 | 3/8 | 1527324-3 |
| | | | | | | | | 1/2 | 1527323-3 |
| 2/0 | Black | .443 | 2.500 | .830 | .450 | 1.105 | .140 | 5/16 | 1527589-3 |
| | | 11.25 | 63.50 | 21.08 | 11.43 | 28.07 | 3.56 | 3/8 | 1527325-3 |
| | | | | | | | | 1/2 | 1527326-3 |
| 3/0 | Orange | .490 | 2.700 | .910 | .450 | 1.175 | .140 | 5/16 | 1527590-3 |
| | | 12.45 | 68.58 | 23.11 | 11.43 | 29.85 | 3.56 | 3/8 | 1527327-3 |
| | | | | | | | | 1/2 | 1527328-3 |
| 4/0 | Purple | .548 | 3.050 | 1.020 | .500 | 1.225 | .156 | 5/16 | 1527593-3 |
| | | 13.92 | 77.47 | 25.91 | 12.70 | 31.12 | 3.97 | 3/8 | 1527329-3 |
| | | | | | | | | 1/2 | 1527330-3 |
| 250 MCM | Yellow | .600 | 3.350 | 1.140 | .500 | 1.275 | .186 | 3/8 | 1527331-3 |
| | | 15.24 | 85.09 | 28.96 | 12.70 | 32.39 | 4.72 | 1/2 | 1527332-3 |
| 300 MCM | White | .660 | 3.500 | 1.220 | .500 | 1.285 | .186 | 3/8 | 1527334-3 |
| | | 17.64 | 88.90 | 30.98 | 12.70 | 32.64 | 4.72 | 1/2 | 1527335-3 |
| 350 MCM | Red | .711 | 3.700 | 1.320 | .560 | 1.335 | .202 | 3/8 | 1527336-3 |
| | | 18.05 | 93.98 | 33.53 | 14.22 | 33.90 | 5.13 | 1/2 | 1527337-3 |
| 400 MCM | Blue | .758 | 3.900 | 1.400 | .560 | 1.445 | .218 | 1/2 | 1527340-3 |
| | | 19.25 | 99.06 | 35.56 | 14.22 | 36.70 | 5.54 | | |
| 500 MCM | Brown | .843 | 4.500 | 1.580 | .560 | 1.465 | .250 | 3/8 | 1527341-3 |
| | | 21.41 | 114.30 | 40.13 | 14.22 | 37.21 | 6.35 | 1/2 | 1527343-3 |

Copper Compression Lugs and Splices (Continued)

Long Barrel Lug with Two Stud Holes

Wire Size Range
8 AWG to 500 MCM

Material

Terminal Body — Copper per ASTM B-75

Plating — Tin per ASTM B-545

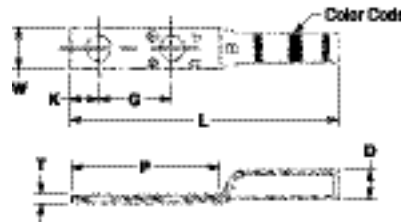

| AWG | Color Code | Dimensions | | | | | | | Stud Size | Part Number |
|---------|------------|------------|--------|-------|-------|-------|-------|------|-----------|-------------|
| | | D | L | W | K | P | G | T | | |
| 8 | Red | .170 | 2.250 | .350 | .250 | 1.266 | .625 | .078 | 10 | 1527344-3 |
| | | 4.32 | 57.15 | 8.89 | 6.35 | 32.15 | 15.88 | 1.98 | | |
| 6 | Blue | .204 | 2.300 | .400 | .250 | 1.315 | .625 | .078 | 1/4 | 1527347-3 |
| | | 5.18 | 58.42 | 10.16 | 6.35 | 33.40 | 15.88 | 1.98 | | |
| 4 | Grey | .252 | 2.350 | .500 | .300 | 1.335 | .625 | .108 | 1/4 | 1527351-3 |
| | | 6.40 | 59.69 | 12.70 | 7.62 | 33.91 | 15.88 | 2.74 | | |
| 2 | Brown | .312 | 2.800 | .610 | .350 | 1.565 | .750 | .124 | 1/4 | 1527353-3 |
| | | 7.93 | 71.12 | 15.49 | 8.89 | 39.75 | 19.05 | 3.15 | 5/16 | 1527355-3 |
| 1 | Green | .352 | 3.100 | .690 | .350 | 1.765 | .750 | .134 | 1/4 | — |
| | | 8.94 | 78.74 | 17.53 | 8.89 | 44.83 | 19.05 | 3.40 | 5/16 | 1527357-3 |
| 1/0 | Pink | .393 | 3.200 | .760 | .400 | 1.825 | .750 | .140 | 5/16 | 1527358-3 |
| | | 9.98 | 81.28 | 19.30 | 10.16 | 46.36 | 19.05 | 3.56 | 3/8 | 1527359-3 |
| 2/0 | Black | .443 | 4.510 | .830 | .620 | 3.095 | 1.750 | .140 | 3/8 | 1527360-3 |
| | | 11.25 | 114.55 | 21.08 | 15.75 | 78.61 | 44.45 | 3.56 | 1/2 | 1527361-3 |
| 3/0 | Orange | .490 | 4.650 | .910 | .620 | 3.125 | 1.750 | .140 | 3/8 | 1527362-3 |
| | | 12.45 | 118.11 | 23.11 | 15.75 | 79.38 | 44.45 | 3.56 | 1/2 | 1527363-3 |
| 4/0 | Purple | .548 | 4.950 | 1.020 | .620 | 3.125 | 1.750 | .156 | 3/8 | 1527364-3 |
| | | 13.92 | 125.73 | 25.91 | 15.75 | 79.38 | 44.45 | 3.96 | 1/2 | 1527365-3 |
| 250 MCM | Yellow | .600 | 5.200 | 1.140 | .620 | 3.125 | 1.750 | .186 | 3/8 | 1527366-3 |
| | | 15.24 | 132.08 | 28.96 | 15.75 | 79.38 | 44.45 | 4.72 | 1/2 | 1527367-3 |
| 300 MCM | White | .660 | 5.350 | 1.220 | .620 | 3.135 | 1.750 | .186 | 3/8 | 1527369-3 |
| | | 16.76 | 135.89 | 30.99 | 15.75 | 79.63 | 44.45 | 4.72 | 1/2 | 1527370-3 |
| 350 MCM | Red | .711 | 5.500 | 1.320 | .620 | 3.135 | 1.750 | .202 | 3/8 | 1527371-3 |
| | | 18.06 | 139.70 | 33.53 | 15.75 | 79.63 | 44.45 | 5.13 | 1/2 | 1527373-3 |
| 400 MCM | Blue | .758 | 5.600 | 1.400 | .620 | 3.145 | 1.750 | .218 | 3/8 | 1527374-3 |
| | | 19.25 | 142.24 | 35.56 | 15.75 | 79.88 | 44.45 | 5.54 | 1/2 | 1527375-3 |
| 500 MCM | Brown | .843 | 6.200 | 1.580 | .620 | 3.165 | 1.750 | .250 | 3/8 | 1527377-3 |
| | | 21.41 | 157.48 | 63.33 | 15.75 | 80.39 | 44.45 | 6.35 | 1/2 | 1527378-3 |

Copper Compression Lugs and Splices (Continued)

Standard Barrel Butt Splices, Color Coded

**Wire Size Range
8 AWG to 500 MCM**

Material

Terminal Body — Copper per ASTM B-75

Plating — Tin per ASTM B-545

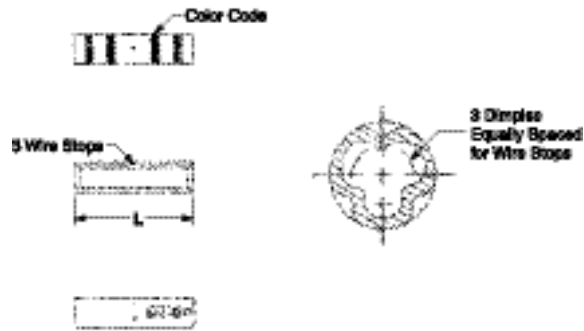

| AWG | Color Code | Barrel I.D. | Dim. L | Part Number |
|---------|------------|---------------|----------------|-------------|
| 8 | Red | .170 4.32 | 1.000 25.40 | 1527379-3 |
| 6 | Blue | .204 5.18 | 1.000 25.40 | 1527380-3 |
| 4 | Grey | .252 6.40 | 1.000 25.40 | 1527381-3 |
| 2 | Brown | .312 7.92 | 1.250 31.75 | 1527382-3 |
| 1 | Green | .352 8.94 | 1.440 36.58 | 1527383-3 |
| 1/0 | Pink | .393 9.98 | 1.440 36.58 | 1527384-3 |
| 2/0 | Black | .443 11.25 | 1.560 39.62 | 1527385-3 |
| 3/0 | Orange | .490 12.45 | 1.690 42.93 | 1527386-3 |
| 4/0 | Purple | .548 13.92 | 1.820 46.23 | 1527387-3 |
| 250 MCM | Yellow | .600 15.24 | 2.190 55.63 | 1527388-3 |
| 300 MCM | White | .660 16.76 | 2.190 55.63 | 1527389-3 |
| 350 MCM | Red | .711 18.06 | 2.190 55.63 | 1527390-3 |
| 400 MCM | Blue | .758 19.25 | 2.750 69.85 | 1527264-3 |
| 500 MCM | Brown | .843 21.41 | 2.750 69.85 | 1527392-3 |

Copper Compression Lugs and Splices (Continued)

**Long Barrel Butt Splices,
Color Coded**

Wire Size Range
8 AWG to 500 MCM

Material

Terminal Body — Copper per
ASTM B-75



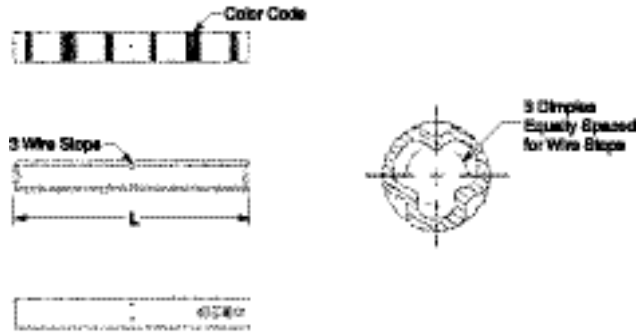



Plating — Tin per ASTM B-545



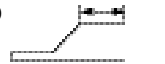
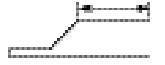

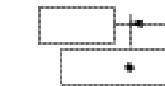
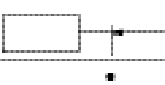

| AWG | Color Code | Barrel I.D. | Dim. L | Part Number |
|---------|------------|---------------|-----------------|-------------|
| 8 | Red | .170 4.32 | 2.000 50.80 | 1527393-3 |
| 6 | Blue | .204 5.18 | 2.000 50.80 | 1527394-3 |
| 4 | Grey | .252 6.40 | 2.000 50.80 | 1527395-3 |
| 2 | Brown | .312 7.92 | 2.000 50.80 | 1527397-3 |
| 1 | Green | .352 8.94 | 2.250 57.15 | 1527398-3 |
| 1/0 | Pink | .393 9.98 | 2.250 57.15 | 1527399-3 |
| 2/0 | Black | .443 11.25 | 2.380 60.45 | 1527400-3 |
| 3/0 | Orange | .490 12.45 | 2.500 63.50 | 1527401-3 |
| 4/0 | Purple | .548 13.92 | 3.000 76.20 | 1527402-3 |
| 250 MCM | Yellow | .600 15.24 | 3.620 91.95 | 1527403-3 |
| 300 MCM | White | .660 16.76 | 3.680 93.47 | 1527404-3 |
| 350 MCM | Red | .711 18.06 | 3.930 99.82 | 1527405-3 |
| 400 MCM | Blue | .758 19.25 | 3.930 99.82 | 1527406-3 |
| 500 MCM | Brown | .843 21.41 | 4.930 125.22 | 1527407-3 |

CUSTOMER INFORMATION: Review with Tyco Electronics Sales Engineer, Tyco Electronics Authorized Distributor, or fax to Tyco Electronics Technical Support.

Company Name _____ Your Name _____
 Address _____ City/State _____
 Telephone Number _____ Fax Number _____



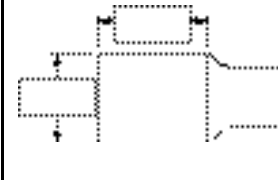

| | | | |
|--|--|---|--|
| Cable Specifications WIRE GAUGE <input type="checkbox"/> 8 <input type="checkbox"/> 1/0 <input type="checkbox"/> 250 MCM <input type="checkbox"/> 6 <input type="checkbox"/> 2/0 <input type="checkbox"/> 300 MCM <input type="checkbox"/> 4 <input type="checkbox"/> 3/0 <input type="checkbox"/> 350 MCM <input type="checkbox"/> 2 <input type="checkbox"/> 4/0 <input type="checkbox"/> 400 MCM <input type="checkbox"/> 1 <input type="checkbox"/> 500 MCM TYPE <input type="checkbox"/> STD <input type="checkbox"/> OTHER SIZE <input type="checkbox"/> FLEX <input type="checkbox"/> _____ | Barrel Length (Lug) <input type="checkbox"/> STANDARD  <input type="checkbox"/> LONG  <input type="checkbox"/> SPECIAL  | PRODUCTION REQUIREMENTS INITIAL QTY. _____ DUE DATE _____ 1ST YEAR QTY. _____ 2ND YEAR QTY. _____ PROGRAM LIFE _____ YRS TARGET PRICE _____ | |
| | Barrel Length (Splice) <input type="checkbox"/> STD SINGLE CRIMP  <input type="checkbox"/> LONG DOUBLE CRIMP  | Barrel Type <input type="checkbox"/> CHAMFERED  <input type="checkbox"/> FLARED  | Sight Hole <input type="checkbox"/> YES  <input type="checkbox"/> NO  |

Tongue Specifications

| | | | |
|--|--|---|---|
| <input type="checkbox"/> SINGLE HOLE  | <input type="checkbox"/> DOUBLE HOLE  | <input type="checkbox"/> BLANK  | <input type="checkbox"/> NARROW  |
|--|--|---|---|

| | | | | | | |
|---|--|---|--|---|---|---|
| Stud Size <input type="checkbox"/> # 8 <input type="checkbox"/> 3/8 <input type="checkbox"/> #10 <input type="checkbox"/> 1/2 <input type="checkbox"/> 1/4 <input type="checkbox"/> 3/4 <input type="checkbox"/> 5/16 <input type="checkbox"/> OTHER <input type="checkbox"/> _____ | Special Features <table border="1"> <tr> <td> BARREL COLOR CODE <input type="checkbox"/> YES <input type="checkbox"/> NO </td> <td> PLATE <input type="checkbox"/> TIN <input type="checkbox"/> OTHER _____ </td> <td> AGENCY APPROVAL <input type="checkbox"/> UL <input type="checkbox"/> CSA <input type="checkbox"/> OTHER _____ </td> </tr> </table> | | | BARREL COLOR CODE <input type="checkbox"/> YES <input type="checkbox"/> NO | PLATE <input type="checkbox"/> TIN <input type="checkbox"/> OTHER _____ | AGENCY APPROVAL <input type="checkbox"/> UL <input type="checkbox"/> CSA <input type="checkbox"/> OTHER _____ |
| BARREL COLOR CODE <input type="checkbox"/> YES <input type="checkbox"/> NO | PLATE <input type="checkbox"/> TIN <input type="checkbox"/> OTHER _____ | AGENCY APPROVAL <input type="checkbox"/> UL <input type="checkbox"/> CSA <input type="checkbox"/> OTHER _____ | | | | |

Angle Specifications

| | | | |
|--|--|---|--|
| <input type="checkbox"/> SINGLE HOLE <input type="checkbox"/> 45°  <input type="checkbox"/> 90°  | <input type="checkbox"/> OTHER  | <input type="checkbox"/> DOUBLE HOLE  | <input type="checkbox"/> DOUBLE HOLE  |
|--|--|---|--|

Fax or Mail to:
 Attn: Tyco Electronics Technical Support, 2800 Fulling Mill Road, Middletown, PA 17057
 Fax Number: 717-986-7575 Phone Number: 1-800-522-6752
 Route to Product Manager GPL D89

Heavy Duty Starter/Battery Lugs and Splices

Super Lugs

Wire Size Range 4 AWG to 4/0 AWG

Heavier wall thickness and wider pads for greater heat sink capabilities. Longer barrels for double crimping when necessary. Color coded barrel.

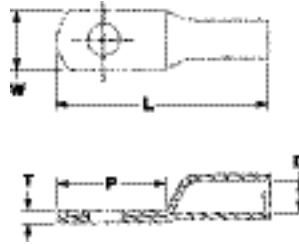

Material

Terminal Body — Copper per ASTM B-75

Plating — Tin per ASTM B-545

| AWG | Optional Color Code | Dimensions | | | | | Stud Size | Part Number | | |
|-----|---------------------|------------|-----------|-----------|-------|-----------|-----------|-------------|-------------------|-----------|
| | | D | L | W | P | T | | Tin Plated | Tin & Color Coded | |
| 4 | Grey | .270 | 1.800 | .525 | .925 | .108 | 1/4 | 1526000-2 | 1526003-3 | |
| | | 6.86 | 45.72 | 13.34 | 23.50 | 2.74 | 5/16 | 1526005-2 | 1526006-3 | |
| | | .270 | 1.800 | .640 | .925 | .108 | 3/8 | 1526007-2 | 1526012-3 | |
| 2 | Green | 6.86 | 45.72 | 16.26 | 23.50 | 2.74 | 1/4 | 1526013-2 | 1526014-3 | |
| | | .352 | 2.100 | .690 | 1.025 | .134 | 5/16 | 1526015-2 | 1526016-3 | |
| | | 8.94 | 53.34 | 17.53 | 26.04 | 3.40 | 3/8 | 1526017-2 | 1526022-3 | |
| 1 | Pink | 1/4 | 1526023-2 | 1526025-3 | 5/16 | 1526026-2 | 1526027-3 | 3/8 | 1526028-2 | 1526033-3 |
| | | .393 | 2.150 | .780 | 1.025 | .160 | 1/2 | 1526034-2 | 1526039-3 | |
| | | 9.98 | 54.61 | 19.81 | 26.04 | 4.06 | 3/8 | 1526041-2 | 1526046-3 | |
| 1/0 | Black | .443 | 2.200 | .850 | 1.025 | .160 | 1/2 | 1526047-2 | 1526052-3 | |
| | | 11.25 | 55.88 | 21.59 | 26.04 | 4.06 | 3/8 | 1526055-2 | 1526060-3 | |
| 2/0 | Orange | .490 | 2.250 | .950 | 1.025 | .180 | 1/2 | 1526061-2 | 1526066-3 | |
| | | 12.45 | 57.15 | 24.13 | 26.04 | 4.57 | 3/8 | 1526070-2 | 1526075-3 | |
| 3/0 | Purple | .548 | 2.500 | 1.040 | 1.025 | .180 | 1/2 | 1526076-2 | 1526081-3 | |
| | | 13.92 | 63.50 | 26.42 | 26.04 | 4.57 | 3/8 | 1526083-2 | 1526088-3 | |
| 4/0 | Yellow | .600 | 2.650 | 1.140 | 1.125 | .186 | 1/2 | 1526089-2 | 1526094-3 | |
| | | 15.24 | 67.31 | 28.96 | 28.58 | 4.72 | | | | |

Super Butt Splices

Wire Size Range 4 AWG to 4/0 AWG

Material

Terminal Body — Copper per ASTM B-75

Plating — Tin per ASTM B-545

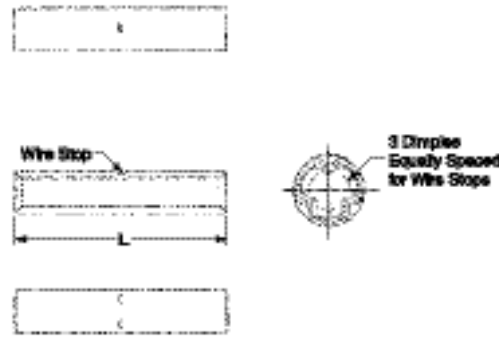

| AWG | Barrel I.D. | Dim. L | Wall | Part Number | |
|-----|-------------|--------|------|-------------|-------------------|
| | | | | Tin Plated | Tin & Color Coded |
| 4 | .252 | 1.800 | .054 | 1526095-2 | 1526096-3 |
| | 6.40 | 45.72 | 1.37 | | |
| 2 | .352 | 2.100 | .067 | 1526097-2 | 1526098-3 |
| | 8.94 | 53.34 | 1.70 | | |
| 1 | .393 | 2.150 | .080 | 1526099-2 | 1526100-3 |
| | 9.98 | 54.61 | 2.03 | | |
| 1/0 | .443 | 2.200 | .080 | 1526101-2 | 1526102-3 |
| | 11.25 | 55.88 | 2.03 | | |
| 2/0 | .490 | 2.250 | .090 | 1526103-2 | 1526104-3 |
| | 12.45 | 57.15 | 2.29 | | |
| 3/0 | .548 | 2.500 | .090 | 1526105-2 | 1526106-3 |
| | 13.92 | 63.50 | 2.29 | | |
| 4/0 | .600 | 2.650 | .093 | 1526107-2 | 1526108-3 |
| | 15.24 | 67.31 | 2.36 | | |

Crimp Tooling

Hand Tool

- Crimps seamless and copper compression lugs from 6 AWG through 4/0
- Unique and simple die-insert design reduces cost, size, and weight
- Compound lever design for easy crimping
- Length: 17.75 [450.85]
- Weight: 63 ounces



Hand Tool Part Number — 1526955-1
Instruction Sheet — 408-8540

| Cable Size | Die Part Number |
|-------------|-----------------|
| 4 and 6 AWG | 1527508-1 |
| 1 and 2 AWG | 1527505-1 |
| 2/0 and 1/0 | 1527507-1 |

AMP to Former AET Part Number Cross Reference

| AMP Part No. | AET Part No. | AMP Part No. | AET Part No. | AMP Part No. | AET Part No. | AMP Part No. | AET Part No. |
|--------------|--------------|--------------|--------------|--------------|--------------|--------------|--------------|
| 1526000-2 | 4149 | 1526118-2 | 8141-09-90 | 1526194-1 | 6382-02 | 1526291-1 | 2141-02 |
| 1526003-3 | 4149-CC | 1526122-1 | 8561-00 | 1526194-2 | 6382-03 | 1526291-2 | 2141-03 |
| 1526005-2 | 4569 | 1526122-2 | 8561-01 | 1526196-1 | 6382-08-90 | 1526293-1 | 2141-08-90 |
| 1526006-3 | 4569-CC | 1526123-1 | 8561-02 | 1526196-2 | 6382-09-90 | 1526293-2 | 2141-09-90 |
| 1526007-2 | 4389 | 1526123-2 | 8561-03 | 1526209-1 | 6383-00 | 1526295-2 | 2141-11-90 |
| 1526012-3 | 4389-CC | 1526128-1 | 8142-00 | 1526209-2 | 6383-01 | 1526397-1 | 2561-00 |
| 1526013-2 | 2149 | 1526128-2 | 8142-01 | 1526210-1 | 6383-02 | 1526397-2 | 2561-01 |
| 1526014-3 | 2149-CC | 1526129-1 | 8142-02 | 1526210-2 | 6383-03 | 1526398-1 | 2561-02 |
| 1526015-2 | 2569 | 1526134-1 | 8562-00 | 1526217-1 | 6503-00 | 1526398-2 | 2561-03 |
| 1526016-3 | 2569-CC | 1526134-2 | 8562-01 | 1526217-2 | 6503-01 | 1526399-1 | 2561-08-45 |
| 1526017-2 | 2389 | 1526135-1 | 8562-02 | 1526218-1 | 6503-02 | 1526400-1 | 2561-08-90 |
| 1526022-3 | 2389-CC | 1526135-2 | 8562-03 | 1526218-2 | 6503-03 | 1526400-2 | 2561-09-90 |
| 1526023-2 | 1149 | 1526142-1 | 8382-00 | 1526220-1 | 6503-08-90 | 1526401-1 | 2561-10-45 |
| 1526025-3 | 1149-CC | 1526142-2 | 8382-01 | 1526220-2 | 6503-09-90 | 1526401-2 | 2561-11-45 |
| 1526026-2 | 1569 | 1526143-1 | 8382-02 | 1526223-1 | 4101-00 | 1526402-1 | 2561-10-90 |
| 1526027-3 | 1569-CC | 1526143-2 | 8382-03 | 1526223-2 | 4101-01 | 1526402-2 | 2561-11-90 |
| 1526028-2 | 1389 | 1526148-1 | 8383-00 | 1526224-1 | 4101-02 | 1526405-1 | 2381-00 |
| 1526033-3 | 1389-CC | 1526148-2 | 8383-01 | 1526224-2 | 4101-03 | 1526405-2 | 2381-01 |
| 1526034-2 | 1509 | 1526149-1 | 8383-02 | 1526229-1 | 4141-00 | 1526406-2 | 2381-03 |
| 1526039-3 | 1509-CC | 1526154-1 | 8503-00 | 1526229-2 | 4141-01 | 1526408-1 | 2381-08-90 |
| 1526041-2 | 10389 | 1526154-2 | 8503-01 | 1526230-1 | 4141-02 | 1526415-1 | 2383-00 |
| 1526046-3 | 10389-CC | 1526155-1 | 8503-02 | 1526230-2 | 4141-03 | 1526415-2 | 2383-01 |
| 1526047-2 | 10509 | 1526155-2 | 8503-03 | 1526232-1 | 4141-08-90 | 1526416-1 | 2383-02 |
| 1526052-3 | 10509-CC | 1526157-1 | 8503-08-90 | 1526232-2 | 4141-09-90 | 1526416-2 | 2383-03 |
| 1526055-2 | 20389 | 1526157-2 | 8503-09-90 | 1526234-2 | 4141-11-90 | 1526423-1 | 2383-10-45 |
| 1526060-3 | 20389-CC | 1526159-1 | 8503-10-90 | 1526235-1 | 4561-00 | 1526431-1 | 2503-00 |
| 1526061-2 | 20509 | 1526159-2 | 8503-11-90 | 1526235-2 | 4561-01 | 1526431-2 | 2503-01 |
| 1526066-3 | 20509-CC | 1526160-1 | 6101-00 | 1526236-1 | 4561-02 | 1526432-1 | 2503-02 |
| 1526070-2 | 30389 | 1526160-2 | 6101-01 | 1526236-2 | 4561-03 | 1526432-2 | 2503-03 |
| 1526075-3 | 30389-CC | 1526161-1 | 6101-02 | 1526237-1 | 4561-08-45 | 1526434-1 | 2503-08-90 |
| 1526076-2 | 30509 | 1526161-2 | 6101-03 | 1526237-2 | 4561-09-45 | 1526434-2 | 2503-09-90 |
| 1526081-3 | 30509-CC | 1526163-1 | 6101-08-90 | 1526240-1 | 4561-10-90 | 1526436-1 | 2503-10-90 |
| 1526083-2 | 40389 | 1526163-2 | 6101-09-90 | 1526242-1 | 4381-00 | 1526436-2 | 2503-11-90 |
| 1526088-3 | 40389-CC | 1526166-1 | 6141-00 | 1526242-2 | 4381-01 | 1526437-1 | 1141-00 |
| 1526089-2 | 40509 | 1526166-2 | 6141-01 | 1526243-2 | 4381-03 | 1526437-2 | 1141-01 |
| 1526094-3 | 40509-CC | 1526167-1 | 6141-02 | 1526245-1 | 4381-08-90 | 1526438-2 | 1141-03 |
| 1526095-2 | 4009 | 1526167-2 | 6141-03 | 1526251-1 | 4562-00 | 1526442-1 | 1141-10-90 |
| 1526096-3 | 4009-CC | 1526168-1 | 6141-08-45 | 1526251-2 | 4562-01 | 1526442-2 | 1141-11-90 |
| 1526097-2 | 2009 | 1526168-2 | 6141-09-45 | 1526252-1 | 4562-02 | 1526443-1 | 1561-02 |
| 1526098-3 | 2009-CC | 1526169-1 | 6141-08-90 | 1526252-2 | 4562-03 | 1526443-2 | 1561-03 |
| 1526099-2 | 1009 | 1526169-2 | 6141-09-90 | 1526253-1 | 4562-08-45 | 1526445-2 | 1561-09-90 |
| 1526100-3 | 1009-CC | 1526170-1 | 6141-10-45 | 1526258-1 | 4382-00 | 1526447-2 | 1561-11-90 |
| 1526102-3 | 10009-CC | 1526170-2 | 6141-11-45 | 1526258-2 | 4382-01 | 1526452-1 | 1381-00 |
| 1526103-2 | 20009 | 1526171-1 | 6141-10-90 | 1526259-1 | 4382-02 | 1526452-2 | 1381-01 |
| 1526104-3 | 20009-CC | 1526171-2 | 6141-11-90 | 1526259-2 | 4382-03 | 1526453-1 | 1381-02 |
| 1526106-3 | 30009-CC | 1526173-1 | 6561-00 | 1526262-1 | 4382-10-45 | 1526453-2 | 1381-03 |
| 1526107-2 | 40009 | 1526173-2 | 6561-01 | 1526267-1 | 4383-00 | 1526454-2 | 1381-09-45 |
| 1526108-3 | 40009-CC | 1526174-1 | 6561-02 | 1526267-2 | 4383-01 | 1526455-1 | 1381-08-90 |
| 1526109-1 | 8101-00 | 1526174-2 | 6561-03 | 1526268-1 | 4383-02 | 1526455-2 | 1381-09-90 |
| 1526109-2 | 8101-01 | 1526181-1 | 6142-00 | 1526268-2 | 4383-03 | 1526457-1 | 1381-10-90 |
| 1526110-1 | 8101-02 | 1526181-2 | 6142-01 | 1526272-2 | 4383-09-45 | 1526459-1 | 1501-00 |
| 1526110-2 | 8101-03 | 1526182-1 | 6142-02 | 1526273-2 | 4383-09-90 | 1526459-2 | 1501-01 |
| 1526111-1 | 8101-08-45 | 1526182-2 | 6142-03 | 1526282-1 | 4503-00 | 1526465-1 | 1383-00 |
| 1526111-2 | 8101-09-45 | 1526187-1 | 6562-00 | 1526282-2 | 4503-01 | 1526465-2 | 1383-01 |
| 1526115-1 | 8141-00 | 1526187-2 | 6562-01 | 1526283-1 | 4503-02 | 1526466-1 | 1383-02 |
| 1526115-2 | 8141-01 | 1526188-1 | 6562-02 | 1526283-2 | 4503-03 | 1526466-2 | 1383-03 |
| 1526116-1 | 8141-02 | 1526188-2 | 6562-03 | 1526284-2 | 4503-09-45 | 1526479-1 | 1503-00 |
| 1526116-2 | 8141-03 | 1526190-1 | 6562-08-90 | 1526285-2 | 4503-09-90 | 1526479-2 | 1503-01 |
| 1526117-1 | 8141-08-45 | 1526190-2 | 6562-09-90 | 1526287-2 | 4503-11-90 | 1526480-1 | 1503-02 |
| 1526117-2 | 8141-09-45 | 1526193-1 | 6382-00 | 1526290-1 | 2141-00 | 1526480-2 | 1503-03 |
| 1526118-1 | 8141-08-90 | 1526193-2 | 6382-01 | 1526290-2 | 2141-01 | 1526486-2 | 1503-09-45 |

Dimensions are in inches and millimeters unless otherwise specified. Values in brackets are metric equivalents.

Dimensions are shown for reference purposes only. Specifications subject to change.

Technical Support
 USA: 1-800-522-6752
 Canada: 1-905-475-6222
 Mexico: 01-800-733-8926

www.tycoelectronics.com

AMP to Former AET Part Number Cross Reference (Continued)

| AMP Part No. | AET Part No. | AMP Part No. | AET Part No. | AMP Part No. | AET Part No. | AMP Part No. | AET Part No. |
|--------------|--------------|--------------|--------------|--------------|--------------|--------------|--------------|
| 1526487-2 | 1503-09-90 | 1526769-2 | 20381-09-90 | 1526863-1 | 40382-00 | 1526967-2 | 10001 |
| 1526490-1 | 10141-00 | 1526770-1 | 20381-10-45 | 1526863-2 | 40382-01 | 1526968-2 | 20001 |
| 1526490-2 | 10141-01 | 1526772-1 | 20381-10-90 | 1526868-1 | 40382-10-45 | 1526969-2 | 30001 |
| 1526491-1 | 10141-02 | 1526781-1 | 20501-00 | 1526873-1 | 40502-00 | 1526970-2 | 40000 |
| 1526491-2 | 10141-03 | 1526781-2 | 20501-01 | 1526873-2 | 40502-01 | 1526971-2 | 40001 |
| 1526596-1 | 10561-00 | 1526782-1 | 20501-02 | 1526874-1 | 40502-02 | 1526972-2 | 40002 |
| 1526596-2 | 10561-01 | 1526782-2 | 20501-03 | 1526874-2 | 40502-03 | 1526979-2 | 8001-20 |
| 1526597-1 | 10561-02 | 1526783-1 | 20501-08-45 | 1526878-2 | 40502-09-90 | 1526980-2 | 6001-20 |
| 1526597-2 | 10561-03 | 1526783-2 | 20501-09-45 | 1526879-1 | 40502-10-45 | 1526981-2 | 4001-20 |
| 1526698-2 | 10561-09-45 | 1526784-1 | 20501-08-90 | 1526880-1 | 40502-10-90 | 1526982-2 | 2001-20 |
| 1526699-1 | 10561-08-90 | 1526784-2 | 20501-09-90 | 1526883-1 | 40582-00 | 1526983-2 | 1001-20 |
| 1526699-2 | 10561-09-90 | 1526786-1 | 20501-10-45 | 1526883-2 | 40582-01 | 1526984-2 | 10001-20 |
| 1526701-2 | 10561-11-90 | 1526788-1 | 20501-10-90 | 1526884-1 | 40582-02 | 1526985-2 | 20001-20 |
| 1526704-1 | 10381-00 | 1526793-1 | 30141-00 | 1526884-2 | 40582-03 | 1526987-2 | 40000-20 |
| 1526704-2 | 10381-01 | 1526793-2 | 30141-01 | 1526892-1 | 40383-00 | 1526989-2 | 40002-20 |
| 1526705-1 | 10381-02 | 1526794-2 | 30141-03 | 1526892-2 | 40383-01 | 1526990-3 | 8001-25 |
| 1526705-2 | 10381-03 | 1526796-2 | 30141-09-90 | 1526893-1 | 40383-02 | 1526991-3 | 6001-25 |
| 1526706-1 | 10381-08-45 | 1526799-1 | 30561-00 | 1526893-2 | 40383-03 | 1526992-3 | 4001-25 |
| 1526706-2 | 10381-09-45 | 1526799-2 | 30561-01 | 1526896-1 | 40383-08-45 | 1526993-3 | 2001-25 |
| 1526707-1 | 10381-08-90 | 1526800-1 | 30561-02 | 1526897-2 | 40383-09-90 | 1526994-3 | 1001-25 |
| 1526707-2 | 10381-09-90 | 1526800-2 | 30561-03 | 1526899-1 | 40383-10-45 | 1526995-3 | 10001-25 |
| 1526708-1 | 10381-10-45 | 1526804-1 | 30561-10-90 | 1526899-2 | 40383-11-45 | 1526996-3 | 20001-25 |
| 1526713-1 | 10501-00 | 1526805-1 | 30381-00 | 1526901-1 | 40383-10-90 | 1526997-3 | 30001-25 |
| 1526713-2 | 10501-01 | 1526805-2 | 30381-01 | 1526901-2 | 40383-11-90 | 1526998-3 | 40000-25 |
| 1526714-1 | 10501-02 | 1526806-1 | 30381-02 | 1526911-1 | 40503-00 | 1527096-3 | 1561-60 |
| 1526714-2 | 10501-03 | 1526806-2 | 30381-03 | 1526911-2 | 40503-01 | 1527115-3 | 8101-60 |
| 1526715-2 | 10501-09-45 | 1526809-1 | 30381-08-45 | 1526912-1 | 40503-02 | 1527117-3 | 8141-60 |
| 1526716-1 | 10501-08-90 | 1526810-1 | 30381-08-90 | 1526912-2 | 40503-03 | 1527119-3 | 8142-60 |
| 1526716-2 | 10501-09-90 | 1526810-2 | 30381-09-90 | 1526913-1 | 40503-08-45 | 1527120-3 | 8562-60 |
| 1526719-1 | 10383-00 | 1526813-1 | 30381-10-90 | 1526914-1 | 40503-08-90 | 1527121-3 | 8382-60 |
| 1526719-2 | 10383-01 | 1526819-1 | 30501-00 | 1526914-2 | 40503-09-90 | 1527122-3 | 8383-60 |
| 1526720-1 | 10383-02 | 1526819-2 | 30501-01 | 1526916-1 | 40503-10-45 | 1527123-3 | 8503-60 |
| 1526720-2 | 10383-03 | 1526820-1 | 30501-02 | 1526918-1 | 40503-10-90 | 1527124-3 | 6101-60 |
| 1526726-1 | 10383-10-45 | 1526820-2 | 30501-03 | 1526918-2 | 40503-11-90 | 1527125-3 | 6141-60 |
| 1526727-1 | 10383-10-90 | 1526822-1 | 30501-08-90 | 1526922-1 | 40583-00 | 1527126-3 | 6142-60 |
| 1526731-1 | 10503-00 | 1526822-2 | 30501-09-90 | 1526922-2 | 40583-01 | 1527127-3 | 6562-60 |
| 1526731-2 | 10503-01 | 1526824-1 | 30501-10-45 | 1526923-1 | 40583-02 | 1527128-3 | 6382-60 |
| 1526732-1 | 10503-02 | 1526830-1 | 40141-00 | 1526923-2 | 40583-03 | 1527129-3 | 6383-60 |
| 1526732-2 | 10503-03 | 1526830-2 | 40141-01 | 1526928-1 | 250381-00 | 1527130-3 | 6503-60 |
| 1526735-1 | 10503-10-45 | 1526831-1 | 40141-02 | 1526928-2 | 250381-01 | 1527131-3 | 4101-60 |
| 1526736-1 | 10503-10-90 | 1526831-2 | 40141-03 | 1526929-1 | 250381-02 | 1527132-3 | 4141-60 |
| 1526738-1 | 20141-00 | 1526837-1 | 40561-00 | 1526929-2 | 250381-03 | 1527135-3 | 4562-60 |
| 1526738-2 | 20141-01 | 1526837-2 | 40561-01 | 1526934-1 | 250501-00 | 1527136-3 | 4382-60 |
| 1526739-1 | 20141-02 | 1526838-2 | 40561-03 | 1526934-2 | 250501-01 | 1527137-3 | 4383-60 |
| 1526739-2 | 20141-03 | 1526844-1 | 40381-00 | 1526937-2 | 250501-09-90 | 1527138-3 | 4503-60 |
| 1526743-1 | 20141-10-90 | 1526844-2 | 40381-01 | 1526941-1 | 250581-00 | 1527139-3 | 2141-60 |
| 1526743-2 | 20141-11-90 | 1526845-2 | 40381-03 | 1526941-2 | 250581-01 | 1527140-3 | 2561-60 |
| 1526745-1 | 20561-00 | 1526848-2 | 40381-09-45 | 1526943-1 | 250581-08-45 | 1527141-3 | 2381-60 |
| 1526745-2 | 20561-01 | 1526849-1 | 40381-08-90 | 1526943-2 | 250581-09-45 | 1527142-3 | 2383-60 |
| 1526746-1 | 20561-02 | 1526849-2 | 40381-09-90 | 1526944-1 | 250581-08-90 | 1527143-3 | 2503-60 |
| 1526746-2 | 20561-03 | 1526852-1 | 40501-00 | 1526944-2 | 250581-09-90 | 1527144-3 | 1141-60 |
| 1526747-2 | 20561-09-45 | 1526852-2 | 40501-01 | 1526945-1 | 250581-10-45 | 1527146-3 | 1381-60 |
| 1526751-1 | 20561-10-90 | 1526853-1 | 40501-02 | 1526945-2 | 250581-11-45 | 1527147-3 | 1383-60 |
| 1526751-2 | 20561-11-90 | 1526853-2 | 40501-03 | 1526946-1 | 250581-10-90 | 1527148-3 | 1503-60 |
| 1526758-1 | 20381-00 | 1526854-1 | 40501-08-45 | 1526946-2 | 250581-11-90 | 1527149-3 | 10141-60 |
| 1526758-2 | 20381-01 | 1526854-2 | 40501-09-45 | 1526950-2 | A-4180 | 1527150-3 | 10561-60 |
| 1526759-1 | 20381-02 | 1526856-1 | 40501-08-90 | 1526961-2 | 8001 | 1527151-3 | 10381-60 |
| 1526759-2 | 20381-03 | 1526856-2 | 40501-09-90 | 1526962-2 | 6001 | 1527152-3 | 10501-60 |
| 1526764-1 | 20381-08-45 | 1526857-1 | 40501-10-45 | 1526963-2 | 4001 | 1527153-3 | 10383-60 |
| 1526764-2 | 20381-09-45 | 1526862-1 | 40382-02 | 1526965-2 | 2001 | 1527153-3 | 10503-60 |
| 1526769-1 | 20381-08-90 | 1526862-2 | 40382-03 | 1526966-2 | 1001 | 1527155-3 | 20141-60 |

AMP to Former AET Part Number Cross Reference (Continued)

| AMP Part No. | AET Part No. | AMP Part No. | AET Part No. | AMP Part No. | AET Part No. | AMP Part No. | AET Part No. |
|--------------|--------------|--------------|--------------|--------------|--------------|--------------|--------------|
| 1527156-3 | 20561-60 | 1527256-3 | 300507 | 1527320-3 | L-1147 | 1527380-3 | 6007 |
| 1527157-3 | 20381-60 | 1527258-3 | 300587 | 1527321-3 | L-1567 | 1527381-3 | 4007 |
| 1527158-3 | 20501-60 | 1527259-3 | 350387 | 1527322-3 | L-10567 | 1527382-3 | 2007 |
| 1527159-3 | 30141-60 | 1527260-3 | 350507 | 1527323-3 | L-10507 | 1527383-3 | 1007 |
| 1527160-3 | 30561-60 | 1527261-3 | 350587 | 1527324-3 | L-10387 | 1527384-3 | 10007 |
| 1527161-1 | 30381-60 | 1527263-3 | 400507 | 1527325-3 | L-20387 | 1527385-3 | 20007 |
| 1527162-3 | 30501-60 | 1527264-3 | 400007 | 1527326-3 | L-20507 | 1527386-3 | 30007 |
| 1527163-3 | 40141-60 | 1527266-3 | 400387 | 1527327-3 | L-30387 | 1527387-3 | 40007 |
| 1527164-3 | 40561-60 | 1527267-3 | 500387 | 1527328-3 | L-30507 | 1527388-3 | 250007 |
| 1527165-3 | 40381-60 | 1527268-3 | 500507 | 1527329-3 | L-40387 | 1527389-3 | 300007 |
| 1527166-3 | 40501-60 | 1527270-3 | 500587 | 1527330-3 | L-40507 | 1527390-3 | 350007 |
| 1527208-3 | 8107 | 1527272-3 | 2-8107 | 1527331-3 | L-250387 | 1527392-3 | 500007 |
| 1527209-3 | 8147 | 1527273-3 | 2-6147 | 1527332-3 | L-250507 | 1527393-3 | L-8007 |
| 1527210-3 | 6107 | 1527277-3 | 2-4147 | 1527334-3 | L-300387 | 1527394-3 | L-6007 |
| 1527211-3 | 6147 | 1527278-3 | 2-4567 | 1527335-3 | L-300507 | 1527395-3 | L-4007 |
| 1527214-3 | 6567 | 1527279-3 | 2-2147 | 1527336-3 | L-350387 | 1527397-3 | L-2007 |
| 1527215-3 | 4107 | 1527280-3 | 2-2567 | 1527337-3 | L-350507 | 1527398-3 | L-1007 |
| 1527216-3 | 4147 | 1527281-3 | 2-1147 | 1527340-3 | L-400507 | 1527399-3 | L-10007 |
| 1527217-3 | 4387 | 1527283-3 | 2-1567 | 1527341-3 | L-500387 | 1527400-3 | L-20007 |
| 1527219-3 | 4567 | 1527284-3 | 2-10567 | 1527343-3 | L-500507 | 1527401-3 | L-30007 |
| 1527220-3 | 2147 | 1527285-3 | 2-10387 | 1527344-3 | L2-8107 | 1527402-3 | L-40007 |
| 1527221-3 | 2567 | 1527286-3 | 2-20567 | 1527347-3 | L2-6147 | 1527403-3 | L-250007 |
| 1527222-3 | 2387 | 1527287-3 | 2-20387 | 1527351-3 | L2-4147 | 1527404-3 | L-300007 |
| 1527225-3 | 1147 | 1527288-3 | 2-20507 | 1527353-3 | L2-2147 | 1527405-3 | L-350007 |
| 1527226-3 | 1567 | 1527291-3 | 2-30387 | 1527355-3 | L2-2567 | 1527406-3 | L-400007 |
| 1527227-3 | 1387 | 1527293-3 | 2-30507 | 1527357-3 | L2-1567 | 1527407-3 | L-500007 |
| 1527228-3 | 1507 | 1527294-3 | 2-40387 | 1527358-3 | L2-10567 | 1527589-3 | L-20567 |
| 1527229-3 | 10147 | 1527296-3 | 2-40507 | 1527359-3 | L2-10387 | 1527590-3 | L-30567 |
| 1527230-3 | 10567 | 1527297-3 | 2-250387 | 1527360-3 | L2-20387 | 1527593-3 | L-40567 |
| 1527231-3 | 10387 | 1527298-3 | 2-250507 | 1527361-3 | L2-20507 | | |
| 1527232-3 | 10507 | 1527300-3 | 2-300387 | 1527362-3 | L2-30387 | | |
| 1527233-3 | 20147 | 1527301-3 | 2-300507 | 1527363-3 | L2-30507 | | |
| 1527234-3 | 20567 | 1527302-3 | 2-350387 | 1527364-3 | L2-40387 | | |
| 1527235-3 | 20387 | 1527303-3 | 2-350507 | 1527365-3 | L2-40507 | | |
| 1527237-3 | 20507 | 1527304-3 | 2-400387 | 1527366-3 | L2-250387 | | |
| 1527238-3 | 30147 | 1527305-3 | 2-400507 | 1527367-3 | L2-250507 | | |
| 1527240-3 | 30567 | 1527306-3 | 2-500387 | 1527369-3 | L2-300387 | | |
| 1527242-3 | 30387 | 1527307-3 | 2-500507 | 1527370-3 | L2-300507 | | |
| 1527243-3 | 30507 | 1527309-3 | L-8107 | 1527371-3 | L2-350387 | | |
| 1527244-3 | 40147 | 1527311-3 | L-6147 | 1527373-3 | L2-350507 | | |
| 1527247-3 | 40387 | 1527313-3 | L-4147 | 1527374-3 | L2-400387 | | |
| 1527249-3 | 40507 | 1527315-3 | L-2387 | 1527375-3 | L2-400507 | | |
| 1527251-3 | 250387 | 1527317-3 | L-2147 | 1527377-3 | L2-500387 | | |
| 1527253-3 | 250507 | 1527318-3 | L-2567 | 1527378-3 | L2-500507 | | |
| 1527255-3 | 300387 | 1527319-3 | L-1387 | 1527379-3 | 8007 | | |

AMP to Former AET Tooling Part Number Cross Reference

| AMP Part No. | AET Part No. |
|--------------|--------------|
| 1526955-1 | T-406 |
| 1527505-1 | 5989 |
| 1527507-1 | 5991 |
| 1527508-1 | 5992 |

Former AET to AMP Part Number Cross Reference

| AET Part No. | AMP Part No. | AET Part No. | AMP Part No. | AET Part No. | AMP Part No. | AET Part No. | AMP Part No. |
|--------------|--------------|--------------|--------------|--------------|--------------|--------------|--------------|
| 1001 | 1526966-2 | 30507 | 1527243-3 | 10383-03 | 1526720-2 | 1509-CC | 1526039-3 |
| 1007 | 1527383-3 | 30509 | 1526076-2 | 10383-10-45 | 1526726-1 | 1561-02 | 1526443-1 |
| 1009 | 1526099-2 | 30567 | 1527240-3 | 10383-10-90 | 1526727-1 | 1561-03 | 1526443-2 |
| 1147 | 1527225-3 | 40000 | 1526970-2 | 10383-60 | 1527153-3 | 1561-09-90 | 1526445-2 |
| 1149 | 1526023-2 | 40001 | 1526971-2 | 10389-CC | 1526046-3 | 1561-11-90 | 1526447-2 |
| 1387 | 1527227-3 | 40002 | 1526972-2 | 10501-00 | 1526713-1 | 1561-60 | 1527096-3 |
| 1389 | 1526028-2 | 40007 | 1527387-3 | 10501-01 | 1526713-2 | 1569-CC | 1526027-3 |
| 1507 | 1527228-3 | 40009 | 1526107-2 | 10501-02 | 1526714-1 | 20001-20 | 1526985-2 |
| 1509 | 1526034-2 | 40147 | 1527244-3 | 10501-03 | 1526714-2 | 20001-25 | 1526996-3 |
| 1567 | 1527226-3 | 40387 | 1527247-3 | 10501-08-90 | 1526716-1 | 20009-CC | 1526104-3 |
| 1569 | 1526026-2 | 40389 | 1526083-2 | 10501-09-45 | 1526715-2 | 2001-20 | 1526982-2 |
| 2001 | 1526965-2 | 40507 | 1527249-3 | 10501-09-90 | 1526716-2 | 2001-25 | 1526993-3 |
| 2007 | 1527382-3 | 40509 | 1526089-2 | 10501-60 | 1527152-3 | 2009-CC | 1526098-3 |
| 2009 | 1526097-2 | 2-2147 | 1527279-3 | 10503-00 | 1526731-1 | 20141-00 | 1526738-1 |
| 2147 | 1527220-3 | 2-2567 | 1527280-3 | 10503-01 | 1526731-2 | 20141-01 | 1526738-2 |
| 2149 | 1526013-2 | 250007 | 1527388-3 | 10503-02 | 1526732-1 | 20141-02 | 1526739-1 |
| 2387 | 1527222-3 | 250387 | 1527251-3 | 10503-03 | 1526732-2 | 20141-03 | 1526739-2 |
| 2389 | 1526017-2 | 250507 | 1527253-3 | 10503-10-45 | 1526735-1 | 20141-10-90 | 1526743-1 |
| 2567 | 1527221-3 | 300007 | 1527389-3 | 10503-10-90 | 1526736-1 | 20141-11-90 | 1526743-2 |
| 2569 | 1526015-2 | 300387 | 1527255-3 | 10503-60 | 1527153-3 | 20141-60 | 1527155-3 |
| 4001 | 1526963-2 | 300507 | 1527256-3 | 10509-CC | 1526052-3 | 20381-00 | 1526758-1 |
| 4007 | 1527381-3 | 300587 | 1527258-3 | 10561-00 | 1526596-1 | 20381-01 | 1526758-2 |
| 4009 | 1526095-2 | 350007 | 1527390-3 | 10561-01 | 1526596-2 | 20381-02 | 1526759-1 |
| 4107 | 1527215-3 | 350387 | 1527259-3 | 10561-02 | 1526597-1 | 20381-03 | 1526759-2 |
| 4147 | 1527216-3 | 350507 | 1527260-3 | 10561-03 | 1526597-2 | 20381-08-45 | 1526764-1 |
| 4149 | 1526000-2 | 350587 | 1527261-3 | 10561-08-90 | 1526699-1 | 20381-08-90 | 1526769-1 |
| 4387 | 1527217-3 | 400007 | 1527264-3 | 10561-09-45 | 1526698-2 | 20381-09-45 | 1526764-2 |
| 4389 | 1526007-2 | 400387 | 1527266-3 | 10561-09-90 | 1526699-2 | 20381-09-90 | 1526769-2 |
| 4567 | 1527219-3 | 400507 | 1527263-3 | 10561-11-90 | 1526701-2 | 20381-10-45 | 1526770-1 |
| 4569 | 1526005-2 | 500007 | 1527392-3 | 10561-60 | 1527150-3 | 20381-10-90 | 1526772-1 |
| 6001 | 1526962-2 | 500387 | 1527267-3 | 1141-00 | 1526437-1 | 20381-60 | 1527157-3 |
| 6007 | 1527380-3 | 500507 | 1527268-3 | 1141-01 | 1526437-2 | 20389-CC | 1526060-3 |
| 6107 | 1527210-3 | 500587 | 1527270-3 | 1141-03 | 1526438-2 | 20501-00 | 1526781-1 |
| 6147 | 1527211-3 | 2-4147 | 1527277-3 | 1141-10-90 | 1526442-1 | 20501-01 | 1526781-2 |
| 6567 | 1527214-3 | 2-4567 | 1527278-3 | 1141-11-90 | 1526442-2 | 20501-02 | 1526782-1 |
| 8001 | 1526961-2 | 2-6147 | 1527273-3 | 1141-60 | 1527144-3 | 20501-03 | 1526782-2 |
| 8007 | 1527379-3 | 2-8107 | 1527272-3 | 1149-CC | 1526025-3 | 20501-08-45 | 1526783-1 |
| 8107 | 1527208-3 | 10001-20 | 1526984-2 | 1381-00 | 1526452-1 | 20501-08-90 | 1526784-1 |
| 8147 | 1527209-3 | 10001-25 | 1526995-3 | 1381-01 | 1526452-2 | 20501-09-45 | 1526783-2 |
| 10001 | 1526967-2 | 10009-CC | 1526102-3 | 1381-02 | 1526453-1 | 20501-09-90 | 1526784-2 |
| 10007 | 1527384-3 | 1001-20 | 1526983-2 | 1381-03 | 1526453-2 | 20501-10-45 | 1526786-1 |
| 10147 | 1527229-3 | 1001-25 | 1526994-3 | 1381-08-90 | 1526455-1 | 20501-10-90 | 1526788-1 |
| 10387 | 1527231-3 | 1009-CC | 1526100-3 | 1381-09-45 | 1526454-2 | 20501-60 | 1527158-3 |
| 10389 | 1526041-2 | 10141-00 | 1526490-1 | 1381-09-90 | 1526455-2 | 20509-CC | 1526066-3 |
| 10507 | 1527232-3 | 10141-01 | 1526490-2 | 1381-10-90 | 1526457-1 | 20561-00 | 1526745-1 |
| 10509 | 1526047-2 | 10141-02 | 1526491-1 | 1381-60 | 1527146-3 | 20561-01 | 1526745-2 |
| 10567 | 1527230-3 | 10141-03 | 1526491-2 | 1383-00 | 1526465-1 | 20561-02 | 1526746-1 |
| 20001 | 1526968-2 | 10141-60 | 1527149-3 | 1383-01 | 1526465-2 | 20561-03 | 1526746-2 |
| 20007 | 1527385-3 | 10381-00 | 1526704-1 | 1383-02 | 1526466-1 | 20561-09-45 | 1526747-2 |
| 20009 | 1526103-2 | 10381-01 | 1526704-2 | 1383-03 | 1526466-2 | 20561-10-90 | 1526751-1 |
| 20147 | 1527233-3 | 10381-02 | 1526705-1 | 1383-60 | 1527147-3 | 20561-11-90 | 1526751-2 |
| 20387 | 1527235-3 | 10381-03 | 1526705-2 | 1389-CC | 1526033-3 | 20561-60 | 1527156-3 |
| 20389 | 1526055-2 | 10381-08-45 | 1526706-1 | 1501-00 | 1526459-1 | 2-10387 | 1527285-3 |
| 20507 | 1527237-3 | 10381-08-90 | 1526707-1 | 1501-01 | 1526459-2 | 2-10567 | 1527284-3 |
| 20509 | 1526061-2 | 10381-09-45 | 1526706-2 | 1503-00 | 1526479-1 | 2-1147 | 1527281-3 |
| 20567 | 1527234-3 | 10381-09-90 | 1526707-2 | 1503-01 | 1526479-2 | 2141-00 | 1526290-1 |
| 30001 | 1526969-2 | 10381-10-45 | 1526708-1 | 1503-02 | 1526480-1 | 2141-01 | 1526290-2 |
| 30007 | 1527386-3 | 10381-60 | 1527151-3 | 1503-03 | 1526480-2 | 2141-02 | 1526291-1 |
| 30147 | 1527238-3 | 10383-00 | 1526719-1 | 1503-09-45 | 1526486-2 | 2141-03 | 1526291-2 |
| 30387 | 1527242-3 | 10383-01 | 1526719-2 | 1503-09-90 | 1526487-2 | 2141-08-90 | 1526293-1 |
| 30389 | 1526070-2 | 10383-02 | 1526720-1 | 1503-60 | 1527148-3 | 2141-09-90 | 1526293-2 |

Former AET to AMP Part Number Cross Reference (Continued)

| AET Part No. | AMP Part No. | AET Part No. | AMP Part No. | AET Part No. | AMP Part No. | AET Part No. | AMP Part No. |
|--------------|--------------|--------------|--------------|--------------|--------------|--------------|--------------|
| 2141-11-90 | 1526295-2 | 2561-02 | 1526398-1 | 40381-60 | 1527165-3 | 4101-60 | 1527131-3 |
| 2141-60 | 1527139-3 | 2561-03 | 1526398-2 | 40382-00 | 1526863-1 | 4141-00 | 1526229-1 |
| 2149-CC | 1526014-3 | 2561-08-45 | 1526399-1 | 40382-01 | 1526863-2 | 4141-01 | 1526229-2 |
| 2-1567 | 1527283-3 | 2561-08-90 | 1526400-1 | 40382-02 | 1526862-1 | 4141-02 | 1526230-1 |
| 2-20387 | 1527287-3 | 2561-09-90 | 1526400-2 | 40382-03 | 1526862-2 | 4141-03 | 1526230-2 |
| 2-20507 | 1527288-3 | 2561-10-45 | 1526401-1 | 40382-10-45 | 1526868-1 | 4141-08-90 | 1526232-1 |
| 2-20567 | 1527286-3 | 2561-10-90 | 1526402-1 | 40383-00 | 1526892-1 | 4141-09-90 | 1526232-2 |
| 2-250387 | 1527297-3 | 2561-11-45 | 1526401-2 | 40383-01 | 1526892-2 | 4141-11-90 | 1526234-2 |
| 2-250507 | 1527298-3 | 2561-11-90 | 1526402-2 | 40383-02 | 1526893-1 | 4141-60 | 1527132-3 |
| 2-300387 | 1527300-3 | 2561-60 | 1527140-3 | 40383-03 | 1526893-2 | 4149-CC | 1526003-3 |
| 2-300507 | 1527301-3 | 2569-CC | 1526016-3 | 40383-08-45 | 1526896-1 | 4381-00 | 1526242-1 |
| 2-30387 | 1527291-3 | 30001-25 | 1526997-3 | 40383-09-90 | 1526897-2 | 4381-01 | 1526242-2 |
| 2-30507 | 1527293-3 | 30009-CC | 1526106-3 | 40383-10-45 | 1526899-1 | 4381-03 | 1526243-2 |
| 2-350387 | 1527302-3 | 30141-00 | 1526793-1 | 40383-10-90 | 1526901-1 | 4381-08-90 | 1526245-1 |
| 2-350507 | 1527303-3 | 30141-01 | 1526793-2 | 40383-11-45 | 1526899-2 | 4382-00 | 1526258-1 |
| 2381-00 | 1526405-1 | 30141-03 | 1526794-2 | 40383-11-90 | 1526901-2 | 4382-01 | 1526258-2 |
| 2381-01 | 1526405-2 | 30141-09-90 | 1526796-2 | 40389-CC | 1526088-3 | 4382-02 | 1526259-1 |
| 2381-03 | 1526406-2 | 30141-60 | 1527159-3 | 40501-00 | 1526852-1 | 4382-03 | 1526259-2 |
| 2381-08-90 | 1526408-1 | 30381-00 | 1526805-1 | 40501-01 | 1526852-2 | 4382-10-45 | 1526262-1 |
| 2381-60 | 1527141-3 | 30381-01 | 1526805-2 | 40501-02 | 1526853-1 | 4382-60 | 1527136-3 |
| 2383-00 | 1526415-1 | 30381-02 | 1526806-1 | 40501-03 | 1526853-2 | 4383-00 | 1526267-1 |
| 2383-01 | 1526415-2 | 30381-03 | 1526806-2 | 40501-08-45 | 1526854-1 | 4383-01 | 1526267-2 |
| 2383-02 | 1526416-1 | 30381-08-45 | 1526809-1 | 40501-08-90 | 1526856-1 | 4383-02 | 1526268-1 |
| 2383-03 | 1526416-2 | 30381-08-90 | 1526810-1 | 40501-09-45 | 1526854-2 | 4383-03 | 1526268-2 |
| 2383-10-45 | 1526423-1 | 30381-09-90 | 1526810-2 | 40501-09-90 | 1526856-2 | 4383-09-45 | 1526272-2 |
| 2383-60 | 1527142-3 | 30381-10-90 | 1526813-1 | 40501-10-45 | 1526857-1 | 4383-09-90 | 1526273-2 |
| 2389-CC | 1526022-3 | 30381-60 | 1527161-1 | 40501-60 | 1527166-3 | 4383-60 | 1527137-3 |
| 2-400387 | 1527304-3 | 30389-CC | 1526075-3 | 40502-00 | 1526873-1 | 4389-CC | 1526012-3 |
| 2-400507 | 1527305-3 | 30501-00 | 1526819-1 | 40502-01 | 1526873-2 | 4503-00 | 1526282-1 |
| 2-40387 | 1527294-3 | 30501-01 | 1526819-2 | 40502-02 | 1526874-1 | 4503-01 | 1526282-2 |
| 2-40507 | 1527296-3 | 30501-02 | 1526820-1 | 40502-03 | 1526874-2 | 4503-02 | 1526283-1 |
| 2-500387 | 1527306-3 | 30501-03 | 1526820-2 | 40502-09-90 | 1526878-2 | 4503-03 | 1526283-2 |
| 2-500507 | 1527307-3 | 30501-08-90 | 1526822-1 | 40502-10-45 | 1526879-1 | 4503-09-45 | 1526284-2 |
| 2503-00 | 1526431-1 | 30501-09-90 | 1526822-2 | 40502-10-90 | 1526880-1 | 4503-09-90 | 1526285-2 |
| 2503-01 | 1526431-2 | 30501-10-45 | 1526824-1 | 40503-00 | 1526911-1 | 4503-11-90 | 1526287-2 |
| 2503-02 | 1526432-1 | 30501-60 | 1527162-3 | 40503-01 | 1526911-2 | 4503-60 | 1527138-3 |
| 2503-03 | 1526432-2 | 30509-CC | 1526081-3 | 40503-02 | 1526912-1 | 4561-00 | 1526235-1 |
| 2503-08-90 | 1526434-1 | 30561-00 | 1526799-1 | 40503-03 | 1526912-2 | 4561-01 | 1526235-2 |
| 2503-09-90 | 1526434-2 | 30561-01 | 1526799-2 | 40503-08-45 | 1526913-1 | 4561-02 | 1526236-1 |
| 2503-10-90 | 1526436-1 | 30561-02 | 1526800-1 | 40503-08-90 | 1526914-1 | 4561-03 | 1526236-2 |
| 2503-11-90 | 1526436-2 | 30561-03 | 1526800-2 | 40503-09-90 | 1526914-2 | 4561-08-45 | 1526237-1 |
| 2503-60 | 1527143-3 | 30561-10-90 | 1526804-1 | 40503-10-45 | 1526916-1 | 4561-09-45 | 1526237-2 |
| 250381-00 | 1526928-1 | 30561-60 | 1527160-3 | 40503-10-90 | 1526918-1 | 4561-10-90 | 1526240-1 |
| 250381-01 | 1526928-2 | 40000-20 | 1526987-2 | 40503-11-90 | 1526918-2 | 4562-00 | 1526251-1 |
| 250381-02 | 1526929-1 | 40000-25 | 1526998-3 | 40509-CC | 1526094-3 | 4562-01 | 1526251-2 |
| 250381-03 | 1526929-2 | 40002-20 | 1526989-2 | 40561-00 | 1526837-1 | 4562-02 | 1526252-1 |
| 250501-00 | 1526934-1 | 40009-CC | 1526108-3 | 40561-01 | 1526837-2 | 4562-03 | 1526252-2 |
| 250501-01 | 1526934-2 | 4001-20 | 1526981-2 | 40561-03 | 1526838-2 | 4562-08-45 | 1526253-1 |
| 250501-09-90 | 1526937-2 | 4001-25 | 1526992-3 | 40561-60 | 1527164-3 | 4562-60 | 1527135-3 |
| 250581-00 | 1526941-1 | 4009-CC | 1526096-3 | 40582-00 | 1526883-1 | 4569-CC | 1526006-3 |
| 250581-01 | 1526941-2 | 40141-00 | 1526830-1 | 40582-01 | 1526883-2 | 6001-20 | 1526980-2 |
| 250581-08-45 | 1526943-1 | 40141-01 | 1526830-2 | 40582-02 | 1526884-1 | 6001-25 | 1526991-3 |
| 250581-08-90 | 1526944-1 | 40141-02 | 1526831-1 | 40582-03 | 1526884-2 | 6101-00 | 1526160-1 |
| 250581-09-45 | 1526943-2 | 40141-03 | 1526831-2 | 40583-00 | 1526922-1 | 6101-01 | 1526160-2 |
| 250581-09-90 | 1526944-2 | 40141-60 | 1527163-3 | 40583-01 | 1526922-2 | 6101-02 | 1526161-1 |
| 250581-10-45 | 1526945-1 | 40381-00 | 1526844-1 | 40583-02 | 1526923-1 | 6101-03 | 1526161-2 |
| 250581-10-90 | 1526946-1 | 40381-01 | 1526844-2 | 40583-03 | 1526923-2 | 6101-08-90 | 1526163-1 |
| 250581-11-45 | 1526945-2 | 40381-03 | 1526845-2 | 4101-00 | 1526223-1 | 6101-09-90 | 1526163-2 |
| 250581-11-90 | 1526946-2 | 40381-08-90 | 1526849-1 | 4101-01 | 1526223-2 | 6101-60 | 1527124-3 |
| 2561-00 | 1526397-1 | 40381-09-45 | 1526848-2 | 4101-02 | 1526224-1 | 6141-00 | 1526166-1 |
| 2561-01 | 1526397-2 | 40381-09-90 | 1526849-2 | 4101-03 | 1526224-2 | 6141-01 | 1526166-2 |

Dimensions are in inches and millimeters unless otherwise specified. Values in brackets are metric equivalents.

Dimensions are shown for reference purposes only. Specifications subject to change.

Technical Support
 USA: 1-800-522-6752
 Canada: 1-905-475-6222
 Mexico: 01-800-733-8926

www.tycoelectronics.com

Former AET to AMP Part Number Cross Reference (Continued)

| AET Part No. | AMP Part No. | AET Part No. | AMP Part No. | AET Part No. | AMP Part No. | AET Part No. | AMP Part No. |
|--------------|--------------|--------------|--------------|--------------|--------------|--------------|--------------|
| 6141-02 | 1526167-1 | 6562-60 | 1527127-3 | 8562-00 | 1526134-1 | L-250507 | 1527332-3 |
| 6141-03 | 1526167-2 | 8001-20 | 1526979-2 | 8562-01 | 1526134-2 | L-2567 | 1527318-3 |
| 6141-08-45 | 1526168-1 | 8001-25 | 1526990-3 | 8562-02 | 1526135-1 | L2-6147 | 1527347-3 |
| 6141-08-90 | 1526169-1 | 8101-00 | 1526109-1 | 8562-03 | 1526135-2 | L2-8107 | 1527344-3 |
| 6141-09-45 | 1526168-2 | 8101-01 | 1526109-2 | 8562-60 | 1527120-3 | L-300007 | 1527404-3 |
| 6141-09-90 | 1526169-2 | 8101-02 | 1526110-1 | A-4180 | 1526950-2 | L-30007 | 1527401-3 |
| 6141-10-45 | 1526170-1 | 8101-03 | 1526110-2 | L-10007 | 1527399-3 | L-300387 | 1527334-3 |
| 6141-10-90 | 1526171-1 | 8101-08-45 | 1526111-1 | L-1007 | 1527398-3 | L-300507 | 1527335-3 |
| 6141-11-45 | 1526170-2 | 8101-09-45 | 1526111-2 | L-10387 | 1527324-3 | L-30387 | 1527327-3 |
| 6141-11-90 | 1526171-2 | 8101-60 | 1527115-3 | L-10507 | 1527323-3 | L-30507 | 1527328-3 |
| 6141-60 | 1527125-3 | 8141-00 | 1526115-1 | L-10567 | 1527322-3 | L-30567 | 1527590-3 |
| 6142-00 | 1526181-1 | 8141-01 | 1526115-2 | L-1147 | 1527320-3 | L-350007 | 1527405-3 |
| 6142-01 | 1526181-2 | 8141-02 | 1526116-1 | L-1387 | 1527319-3 | L-350387 | 1527336-3 |
| 6142-02 | 1526182-1 | 8141-03 | 1526116-2 | L-1567 | 1527321-3 | L-350507 | 1527337-3 |
| 6142-03 | 1526182-2 | 8141-08-45 | 1526117-1 | L-20007 | 1527400-3 | L-400007 | 1527406-3 |
| 6142-60 | 1527126-3 | 8141-08-90 | 1526118-1 | L-2007 | 1527397-3 | L-40007 | 1527402-3 |
| 6382-00 | 1526193-1 | 8141-09-45 | 1526117-2 | L-20387 | 1527325-3 | L-400507 | 1527340-3 |
| 6382-01 | 1526193-2 | 8141-09-90 | 1526118-2 | L-20507 | 1527326-3 | L-4007 | 1527395-3 |
| 6382-02 | 1526194-1 | 8141-60 | 1527117-3 | L-20567 | 1527589-3 | L-40387 | 1527329-3 |
| 6382-03 | 1526194-2 | 8142-00 | 1526128-1 | L2-10387 | 1527359-3 | L-40507 | 1527330-3 |
| 6382-08-90 | 1526196-1 | 8142-01 | 1526128-2 | L2-10567 | 1527358-3 | L-40567 | 1527593-3 |
| 6382-09-90 | 1526196-2 | 8142-02 | 1526129-1 | L-2147 | 1527317-3 | L-4147 | 1527313-3 |
| 6382-60 | 1527128-3 | 8142-60 | 1527119-3 | L2-1567 | 1527357-3 | L-500007 | 1527407-3 |
| 6383-00 | 1526209-1 | 8382-00 | 1526142-1 | L2-20387 | 1527360-3 | L-500387 | 1527341-3 |
| 6383-01 | 1526209-2 | 8382-01 | 1526142-2 | L2-20507 | 1527361-3 | L-500507 | 1527343-3 |
| 6383-02 | 1526210-1 | 8382-02 | 1526143-1 | L2-2147 | 1527353-3 | L-6007 | 1527394-3 |
| 6383-03 | 1526210-2 | 8382-03 | 1526143-2 | L2-250387 | 1527366-3 | L-6147 | 1527311-3 |
| 6383-60 | 1527129-3 | 8382-60 | 1527121-3 | L2-250507 | 1527367-3 | L-8007 | 1527393-3 |
| 6503-00 | 1526217-1 | 8383-00 | 1526148-1 | L2-2567 | 1527355-3 | L-8107 | 1527309-3 |
| 6503-01 | 1526217-2 | 8383-01 | 1526148-2 | L2-300387 | 1527369-3 | | |
| 6503-02 | 1526218-1 | 8383-02 | 1526149-1 | L2-300507 | 1527370-3 | | |
| 6503-03 | 1526218-2 | 8383-60 | 1527122-3 | L2-30387 | 1527362-3 | | |
| 6503-08-90 | 1526220-1 | 8503-00 | 1526154-1 | L2-30507 | 1527363-3 | | |
| 6503-09-90 | 1526220-2 | 8503-01 | 1526154-2 | L2-350387 | 1527371-3 | | |
| 6503-60 | 1527130-3 | 8503-02 | 1526155-1 | L2-350507 | 1527373-3 | | |
| 6561-00 | 1526173-1 | 8503-03 | 1526155-2 | L-2387 | 1527315-3 | | |
| 6561-01 | 1526173-2 | 8503-08-90 | 1526157-1 | L2-400387 | 1527374-3 | | |
| 6561-02 | 1526174-1 | 8503-09-90 | 1526157-2 | L2-400507 | 1527375-3 | | |
| 6561-03 | 1526174-2 | 8503-10-90 | 1526159-1 | L2-40387 | 1527364-3 | | |
| 6562-00 | 1526187-1 | 8503-11-90 | 1526159-2 | L2-40507 | 1527365-3 | | |
| 6562-01 | 1526187-2 | 8503-60 | 1527123-3 | L2-4147 | 1527351-3 | | |
| 6562-02 | 1526188-1 | 8561-00 | 1526122-1 | L-250007 | 1527403-3 | | |
| 6562-03 | 1526188-2 | 8561-01 | 1526122-2 | L2-500387 | 1527377-3 | | |
| 6562-08-90 | 1526190-1 | 8561-02 | 1526123-1 | L2-500507 | 1527378-3 | | |
| 6562-09-90 | 1526190-2 | 8561-03 | 1526123-2 | L-250387 | 1527331-3 | | |

Former AET to AMP Tooling Part Number Cross Reference

| AET Part No. | AMP Part No. |
|--------------|--------------|
| 5989 | 1527505-1 |
| 5991 | 1527507-1 |
| 5992 | 1527508-1 |
| T-406 | 1526955-1 |

Part Number Index

| Part No. | Page | Part No. | Page | Part No. | Page | Part No. | Page |
|-----------|------|-----------|------|-----------|------|-----------|------|
| 1526000-2 | 29 | 1526118-1 | 16 | 1526194-1 | 14 | 1526291-2 | 14 |
| 1526003-3 | 29 | 1526118-2 | 16 | 1526194-2 | 14 | 1526293-1 | 16 |
| 1526005-2 | 29 | 1526122-1 | 12 | 1526196-1 | 16 | 1526293-2 | 16 |
| 1526006-3 | 29 | 1526122-2 | 12 | 1526196-2 | 16 | 1526295-2 | 18 |
| 1526007-2 | 29 | 1526123-1 | 14 | 1526209-1 | 12 | 1526397-1 | 12 |
| 1526012-3 | 29 | 1526123-2 | 14 | 1526209-2 | 12 | 1526397-2 | 12 |
| 1526013-2 | 29 | 1526128-1 | 12 | 1526210-1 | 14 | 1526398-1 | 14 |
| 1526014-3 | 29 | 1526128-2 | 12 | 1526210-2 | 14 | 1526398-2 | 14 |
| 1526015-2 | 29 | 1526129-1 | 14 | 1526217-1 | 12 | 1526399-1 | 16 |
| 1526016-3 | 29 | 1526134-1 | 12 | 1526217-2 | 12 | 1526400-1 | 16 |
| 1526017-2 | 29 | 1526134-2 | 12 | 1526218-1 | 14 | 1526400-2 | 16 |
| 1526022-3 | 29 | 1526135-1 | 14 | 1526218-2 | 14 | 1526401-1 | 18 |
| 1526023-2 | 29 | 1526135-2 | 14 | 1526220-1 | 16 | 1526401-2 | 18 |
| 1526025-3 | 29 | 1526142-1 | 12 | 1526220-2 | 16 | 1526402-1 | 18 |
| 1526026-2 | 29 | 1526142-2 | 12 | 1526223-1 | 12 | 1526402-2 | 18 |
| 1526027-3 | 29 | 1526143-1 | 14 | 1526223-2 | 12 | 1526405-1 | 12 |
| 1526028-2 | 29 | 1526143-2 | 14 | 1526224-1 | 14 | 1526405-2 | 12 |
| 1526033-3 | 29 | 1526148-1 | 12 | 1526224-2 | 14 | 1526406-2 | 14 |
| 1526034-2 | 29 | 1526148-2 | 12 | 1526229-1 | 12 | 1526408-1 | 16 |
| 1526039-3 | 29 | 1526149-1 | 14 | 1526229-2 | 12 | 1526415-1 | 12 |
| 1526041-2 | 29 | 1526154-1 | 12 | 1526230-1 | 14 | 1526415-2 | 12 |
| 1526046-3 | 29 | 1526154-2 | 12 | 1526230-2 | 14 | 1526416-1 | 14 |
| 1526047-2 | 29 | 1526155-1 | 14 | 1526232-1 | 16 | 1526416-2 | 14 |
| 1526052-3 | 29 | 1526155-2 | 14 | 1526232-2 | 16 | 1526423-1 | 18 |
| 1526055-2 | 29 | 1526157-1 | 16 | 1526234-2 | 18 | 1526431-1 | 12 |
| 1526060-3 | 29 | 1526157-2 | 16 | 1526235-1 | 12 | 1526431-2 | 12 |
| 1526061-2 | 29 | 1526159-1 | 18 | 1526235-2 | 12 | 1526432-1 | 14 |
| 1526066-3 | 29 | 1526159-2 | 18 | 1526236-1 | 14 | 1526432-2 | 14 |
| 1526070-2 | 29 | 1526160-1 | 12 | 1526236-2 | 14 | 1526434-1 | 16 |
| 1526075-3 | 29 | 1526160-2 | 12 | 1526237-1 | 16 | 1526434-2 | 16 |
| 1526076-2 | 29 | 1526161-1 | 14 | 1526237-2 | 16 | 1526436-1 | 18 |
| 1526081-3 | 29 | 1526161-2 | 14 | 1526240-1 | 18 | 1526436-2 | 18 |
| 1526083-2 | 29 | 1526163-1 | 16 | 1526242-1 | 12 | 1526437-1 | 12 |
| 1526088-3 | 29 | 1526163-2 | 16 | 1526242-2 | 12 | 1526437-2 | 12 |
| 1526089-2 | 29 | 1526166-1 | 12 | 1526243-2 | 14 | 1526438-2 | 14 |
| 1526094-3 | 29 | 1526166-2 | 12 | 1526245-1 | 16 | 1526442-1 | 18 |
| 1526095-2 | 29 | 1526167-1 | 14 | 1526251-1 | 12 | 1526442-2 | 18 |
| 1526096-3 | 29 | 1526167-2 | 14 | 1526251-2 | 12 | 1526443-1 | 14 |
| 1526097-2 | 29 | 1526168-1 | 16 | 1526252-1 | 14 | 1526443-2 | 14 |
| 1526098-3 | 29 | 1526168-2 | 16 | 1526252-2 | 14 | 1526445-2 | 16 |
| 1526099-2 | 29 | 1526169-1 | 16 | 1526253-1 | 16 | 1526447-2 | 18 |
| 1526100-3 | 29 | 1526169-2 | 16 | 1526258-1 | 12 | 1526452-1 | 12 |
| 1526101-2 | 29 | 1526170-1 | 18 | 1526258-2 | 12 | 1526452-2 | 12 |
| 1526102-3 | 29 | 1526170-2 | 18 | 1526259-1 | 14 | 1526453-1 | 14 |
| 1526103-2 | 29 | 1526171-1 | 18 | 1526259-2 | 14 | 1526453-2 | 14 |
| 1526104-3 | 29 | 1526171-2 | 18 | 1526262-1 | 18 | 1526454-2 | 16 |
| 1526105-2 | 29 | 1526173-1 | 12 | 1526267-1 | 12 | 1526455-1 | 16 |
| 1526106-3 | 29 | 1526173-2 | 12 | 1526267-2 | 12 | 1526455-2 | 16 |
| 1526107-2 | 29 | 1526174-1 | 14 | 1526268-1 | 14 | 1526457-1 | 18 |
| 1526108-3 | 29 | 1526174-2 | 14 | 1526268-2 | 14 | 1526459-1 | 12 |
| 1526109-1 | 12 | 1526181-1 | 12 | 1526272-2 | 16 | 1526459-2 | 12 |
| 1526109-2 | 12 | 1526181-2 | 12 | 1526273-2 | 16 | 1526465-1 | 12 |
| 1526110-1 | 14 | 1526182-1 | 14 | 1526282-1 | 12 | 1526465-2 | 12 |
| 1526110-2 | 14 | 1526182-2 | 14 | 1526282-2 | 12 | 1526466-1 | 14 |
| 1526111-1 | 16 | 1526187-1 | 12 | 1526283-1 | 14 | 1526466-2 | 14 |
| 1526111-2 | 16 | 1526187-2 | 12 | 1526283-2 | 14 | 1526479-1 | 12 |
| 1526115-1 | 12 | 1526188-1 | 14 | 1526284-2 | 16 | 1526479-2 | 12 |
| 1526115-2 | 12 | 1526188-2 | 14 | 1526285-2 | 16 | 1526480-1 | 14 |
| 1526116-1 | 14 | 1526190-1 | 16 | 1526287-2 | 18 | 1526480-2 | 14 |
| 1526116-2 | 14 | 1526190-2 | 16 | 1526290-1 | 12 | 1526486-2 | 16 |
| 1526117-1 | 16 | 1526193-1 | 12 | 1526290-2 | 12 | 1526487-2 | 16 |
| 1526117-2 | 16 | 1526193-2 | 12 | 1526291-1 | 14 | 1526490-1 | 12 |

Dimensions are in inches and millimeters unless otherwise specified. Values in brackets are metric equivalents.

Dimensions are shown for reference purposes only. Specifications subject to change.

Technical Support
 USA: 1-800-522-6752
 Canada: 1-905-475-6222
 Mexico: 01-800-733-8926

www.tycoelectronics.com

Part Number Index (Continued)

| Part No. | Page | Part No. | Page | Part No. | Page | Part No. | Page |
|-----------|------|-----------|------|-----------|------|-----------|------|
| 1526490-2 | 12 | 1526782-2 | 15 | 1526878-2 | 17 | 1526985-2 | 19 |
| 1526491-1 | 14 | 1526783-1 | 17 | 1526879-1 | 18 | 1526987-2 | 19 |
| 1526491-2 | 14 | 1526783-2 | 17 | 1526880-1 | 18 | 1526989-2 | 19 |
| 1526596-1 | 12 | 1526784-1 | 17 | 1526883-1 | 13 | 1526990-3 | 21 |
| 1526596-2 | 12 | 1526784-2 | 17 | 1526883-2 | 13 | 1526991-3 | 21 |
| 1526597-1 | 14 | 1526786-1 | 18 | 1526884-1 | 15 | 1526992-3 | 21 |
| 1526597-2 | 14 | 1526788-1 | 18 | 1526884-2 | 15 | 1526993-3 | 21 |
| 1526701-2 | 18 | 1526793-1 | 13 | 1526892-1 | 13 | 1526994-3 | 21 |
| 1526704-1 | 12 | 1526793-2 | 13 | 1526892-2 | 13 | 1526995-3 | 21 |
| 1526704-2 | 12 | 1526794-2 | 15 | 1526893-1 | 15 | 1526996-3 | 21 |
| 1526705-1 | 14 | 1526796-2 | 17 | 1526893-2 | 15 | 1526997-3 | 21 |
| 1526705-2 | 14 | 1526799-1 | 13 | 1526896-1 | 17 | 1526998-3 | 21 |
| 1526706-1 | 17 | 1526799-2 | 13 | 1526897-2 | 17 | 1527096-3 | 20 |
| 1526706-2 | 17 | 1526800-1 | 15 | 1526899-1 | 18 | 1527115-3 | 20 |
| 1526707-1 | 17 | 1526800-2 | 15 | 1526899-2 | 18 | 1527117-3 | 20 |
| 1526707-2 | 17 | 1526804-1 | 18 | 1526901-1 | 18 | 1527119-3 | 20 |
| 1526708-1 | 18 | 1526805-1 | 13 | 1526901-2 | 18 | 1527120-3 | 20 |
| 1526713-1 | 12 | 1526805-2 | 13 | 1526911-1 | 13 | 1527121-3 | 20 |
| 1526713-2 | 12 | 1526806-1 | 15 | 1526911-2 | 13 | 1527122-3 | 20 |
| 1526714-1 | 14 | 1526806-2 | 15 | 1526912-1 | 15 | 1527123-3 | 20 |
| 1526714-2 | 14 | 1526809-1 | 17 | 1526912-2 | 15 | 1527124-3 | 20 |
| 1526715-2 | 17 | 1526810-1 | 17 | 1526913-1 | 17 | 1527125-3 | 20 |
| 1526716-1 | 17 | 1526810-2 | 17 | 1526914-1 | 17 | 1527126-3 | 20 |
| 1526716-2 | 17 | 1526813-1 | 18 | 1526914-2 | 17 | 1527127-3 | 20 |
| 1526719-1 | 12 | 1526819-1 | 13 | 1526916-1 | 18 | 1527128-3 | 20 |
| 1526719-2 | 12 | 1526819-2 | 13 | 1526918-1 | 18 | 1527129-3 | 20 |
| 1526720-1 | 14 | 1526820-1 | 15 | 1526918-2 | 18 | 1527130-3 | 20 |
| 1526720-2 | 14 | 1526820-2 | 15 | 1526922-1 | 13 | 1527131-3 | 20 |
| 1526726-1 | 18 | 1526822-1 | 17 | 1526922-2 | 13 | 1527132-3 | 20 |
| 1526727-1 | 18 | 1526822-2 | 17 | 1526923-1 | 15 | 1527135-3 | 20 |
| 1526731-1 | 12 | 1526824-1 | 18 | 1526923-2 | 15 | 1527136-3 | 20 |
| 1526731-2 | 12 | 1526830-1 | 13 | 1526928-1 | 13 | 1527137-3 | 20 |
| 1526732-1 | 14 | 1526830-2 | 13 | 1526928-2 | 13 | 1527138-3 | 20 |
| 1526732-2 | 14 | 1526831-1 | 15 | 1526929-1 | 15 | 1527139-3 | 20 |
| 1526735-1 | 18 | 1526831-2 | 15 | 1526929-2 | 15 | 1527140-3 | 20 |
| 1526736-1 | 18 | 1526837-1 | 13 | 1526934-1 | 13 | 1527141-3 | 20 |
| 1526738-1 | 13 | 1526837-2 | 13 | 1526934-2 | 13 | 1527142-3 | 20 |
| 1526738-2 | 13 | 1526838-2 | 15 | 1526937-2 | 17 | 1527143-3 | 20 |
| 1526739-1 | 15 | 1526844-1 | 13 | 1526941-1 | 13 | 1527144-3 | 20 |
| 1526739-2 | 15 | 1526844-2 | 13 | 1526941-2 | 13 | 1527146-3 | 20 |
| 1526743-1 | 18 | 1526845-2 | 15 | 1526945-1 | 18 | 1527147-3 | 20 |
| 1526743-2 | 18 | 1526848-2 | 17 | 1526945-2 | 18 | 1527148-3 | 20 |
| 1526745-1 | 13 | 1526849-1 | 17 | 1526946-1 | 18 | 1527149-3 | 20 |
| 1526745-2 | 13 | 1526849-2 | 17 | 1526946-2 | 18 | 1527150-3 | 20 |
| 1526746-1 | 15 | 1526852-1 | 13 | 1526950-2 | 10 | 1527151-3 | 20 |
| 1526746-2 | 15 | 1526852-2 | 13 | 1526961-2 | 19 | 1527152-3 | 20 |
| 1526747-2 | 17 | 1526853-1 | 15 | 1526962-2 | 19 | 1527153-3 | 20 |
| 1526751-1 | 18 | 1526853-2 | 15 | 1526963-2 | 19 | 1527154-3 | 20 |
| 1526751-2 | 18 | 1526854-1 | 17 | 1526965-2 | 19 | 1527155-3 | 20 |
| 1526758-1 | 13 | 1526854-2 | 17 | 1526966-2 | 19 | 1527156-3 | 20 |
| 1526758-2 | 13 | 1526856-1 | 17 | 1526967-2 | 19 | 1527157-3 | 20 |
| 1526759-1 | 15 | 1526856-2 | 17 | 1526968-2 | 19 | 1527158-3 | 20 |
| 1526759-2 | 15 | 1526857-1 | 18 | 1526969-2 | 19 | 1527159-3 | 20 |
| 1526764-1 | 17 | 1526862-1 | 15 | 1526970-2 | 19 | 1527160-3 | 20 |
| 1526764-2 | 17 | 1526862-2 | 15 | 1526971-2 | 19 | 1527161-1 | 20 |
| 1526769-1 | 17 | 1526863-1 | 13 | 1526972-2 | 19 | 1527162-3 | 20 |
| 1526769-2 | 17 | 1526863-2 | 13 | 1526979-2 | 19 | 1527163-3 | 20 |
| 1526770-1 | 18 | 1526868-1 | 18 | 1526980-2 | 19 | 1527164-3 | 20 |
| 1526772-1 | 18 | 1526873-1 | 13 | 1526981-2 | 19 | 1527165-3 | 20 |
| 1526781-1 | 13 | 1526873-2 | 13 | 1526982-2 | 19 | 1527166-3 | 20 |
| 1526781-2 | 13 | 1526874-1 | 15 | 1526983-2 | 19 | 1527208-3 | 22 |
| 1526782-1 | 15 | 1526874-2 | 15 | 1526984-2 | 19 | 1527209-3 | 22 |

Part Number Index (Continued)

| Part No. | Page | Part No. | Page | Part No. | Page | Part No. | Page |
|-----------|------|-----------|------|-----------|------|-----------|------|
| 1527210-3 | 22 | 1527270-3 | 22 | 1527327-3 | 24 | 1527384-3 | 26 |
| 1527211-3 | 22 | 1527272-3 | 23 | 1527328-3 | 24 | 1527385-3 | 26 |
| 1527214-3 | 22 | 1527273-3 | 23 | 1527329-3 | 24 | 1527386-3 | 26 |
| 1527215-3 | 22 | 1527277-3 | 23 | 1527330-3 | 24 | 1527387-3 | 26 |
| 1527216-3 | 22 | 1527278-3 | 23 | 1527331-3 | 24 | 1527388-3 | 26 |
| 1527217-3 | 22 | 1527279-3 | 23 | 1527332-3 | 24 | 1527389-3 | 26 |
| 1527219-3 | 22 | 1527280-3 | 23 | 1527334-3 | 24 | 1527390-3 | 26 |
| 1527220-3 | 22 | 1527281-3 | 23 | 1527335-3 | 24 | 1527392-3 | 26 |
| 1527221-3 | 22 | 1527283-3 | 23 | 1527336-3 | 24 | 1527393-3 | 27 |
| 1527222-3 | 22 | 1527284-3 | 23 | 1527337-3 | 24 | 1527394-3 | 27 |
| 1527225-3 | 22 | 1527285-3 | 23 | 1527340-3 | 24 | 1527395-3 | 27 |
| 1527226-3 | 22 | 1527286-3 | 23 | 1527341-3 | 24 | 1527397-3 | 27 |
| 1527227-3 | 22 | 1527287-3 | 23 | 1527343-3 | 24 | 1527398-3 | 27 |
| 1527228-3 | 22 | 1527288-3 | 23 | 1527344-3 | 25 | 1527399-3 | 27 |
| 1527229-3 | 22 | 1527291-3 | 23 | 1527347-3 | 25 | 1527400-3 | 27 |
| 1527230-3 | 22 | 1527293-3 | 23 | 1527351-3 | 25 | 1527401-3 | 27 |
| 1527231-3 | 22 | 1527294-3 | 23 | 1527353-3 | 25 | 1527402-3 | 27 |
| 1527232-3 | 22 | 1527296-3 | 23 | 1527355-3 | 25 | 1527403-3 | 27 |
| 1527233-3 | 22 | 1527297-3 | 23 | 1527357-3 | 25 | 1527404-3 | 27 |
| 1527234-3 | 22 | 1527298-3 | 23 | 1527358-3 | 25 | 1527405-3 | 27 |
| 1527235-3 | 22 | 1527300-3 | 23 | 1527359-3 | 25 | 1527406-3 | 27 |
| 1527237-3 | 22 | 1527301-3 | 23 | 1527360-3 | 25 | 1527407-3 | 27 |
| 1527238-3 | 22 | 1527302-3 | 23 | 1527361-3 | 25 | 1527473-2 | 10 |
| 1527240-3 | 22 | 1527303-3 | 23 | 1527362-3 | 25 | 1527480-2 | 10 |
| 1527242-3 | 22 | 1527304-3 | 23 | 1527363-3 | 25 | 1527514-2 | 10 |
| 1527243-3 | 22 | 1527305-3 | 23 | 1527364-3 | 25 | 1527516-2 | 10 |
| 1527244-3 | 22 | 1527306-3 | 23 | 1527365-3 | 25 | 1527523-1 | 10 |
| 1527247-3 | 22 | 1527307-3 | 23 | 1527366-3 | 25 | 1527526-2 | 10 |
| 1527249-3 | 22 | 1527309-3 | 24 | 1527367-3 | 25 | 1527529-2 | 10 |
| 1527251-3 | 22 | 1527311-3 | 24 | 1527369-3 | 25 | 1527530-2 | 10 |
| 1527253-3 | 22 | 1527313-3 | 24 | 1527370-3 | 25 | 1527531-2 | 10 |
| 1527255-3 | 22 | 1527315-3 | 24 | 1527371-3 | 25 | 1527539-2 | 10 |
| 1527256-3 | 22 | 1527317-3 | 24 | 1527373-3 | 25 | 1527546-2 | 10 |
| 1527258-3 | 22 | 1527318-3 | 24 | 1527374-3 | 25 | 1527548-2 | 10 |
| 1527259-3 | 22 | 1527319-3 | 24 | 1527375-3 | 25 | 1527555-2 | 10 |
| 1527260-3 | 22 | 1527320-3 | 24 | 1527377-3 | 25 | 1527589-3 | 24 |
| 1527261-3 | 22 | 1527321-3 | 24 | 1527378-3 | 25 | 1527590-3 | 24 |
| 1527263-3 | 22 | 1527322-3 | 24 | 1527379-3 | 26 | 1527593-3 | 24 |
| 1527264-3 | 26 | 1527323-3 | 24 | 1527380-3 | 26 | | |
| 1527266-3 | 22 | 1527324-3 | 24 | 1527381-3 | 26 | | |
| 1527267-3 | 22 | 1527325-3 | 24 | 1527382-3 | 26 | | |
| 1527268-3 | 22 | 1527326-3 | 24 | 1527383-3 | 26 | | |

Tooling Part Number Index

| Part No. | Page |
|-----------|------|
| 1526955-1 | 30 |
| 1527505-1 | 30 |
| 1527507-1 | 30 |
| 1527508-1 | 30 |

tyco

TYCO ELECTRONICS CORPORATION
HARRISBURG, PA 17105

AMP

Electronics



**H E A V Y D U T Y S E A M L E S S
T E R M I N A L S & S P L I C E S**