

## GaAs MMIC SUB-HARMONICALLY PUMPED MIXER, 20 - 40 GHz

### Typical Applications

The HMC266 is ideal for:

- 23, 26, & 38 GHz Point-to-Point Radios
- LMDS
- SATCOM

### Features

- Input IP3: Up to +17 dBm
- Sub-Harmonically Pumped (x2) LO
- Small Size: 1.34 x 1.49 x 0.01 mm

### Functional Diagram

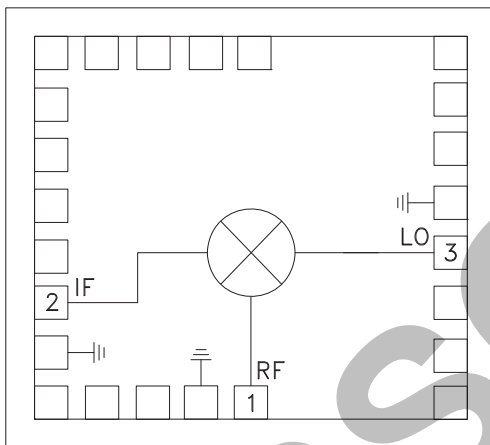

### General Description

The HMC266 chip is a broadband GaAs MMIC sub-harmonically pumped (x2) balanced passive mixer which can be used as an upconverter or downconverter in a small overall chip area of 1.9 mm<sup>2</sup>. The 2LO to RF isolation is excellent eliminating the need for additional filtering. All data is with the chip in a 50 ohm test fixture connected via 0.076 mm (3 mil) ribbon bonds of minimal length <0.31 mm (<12 mils). These devices are much smaller and more reliable than hybrid diode mixer designs.

### Electrical Specifications, $T_A = +25^\circ\text{C}$ , LO Drive = +12 dBm

Parameter	IF = 1 GHz			Units
	Min.	Typ.	Max.	
Frequency Range, RF	20 - 40			GHz
Frequency Range, LO	10 - 20			GHz
Frequency Range, IF	1 - 3			GHz
Conversion Loss		12	16	dB
Noise Figure (SSB)		12	16	dB
2LO to RF Isolation	42	52		dB
LO to RF Isolation	20	24		dB
2LO to IF Isolation	50	60		dB
RF to IF Isolation	16	22		dB
LO to IF Isolation	48	55		dB
IP3 (Input)	10	13		dBm
1 dB Compression (Input)	0	+4		dBm

Information furnished by Analog Devices is believed to be accurate and reliable. However, no responsibility is assumed by Analog Devices for its use, nor for any infringements of patents or other rights of third parties that may result from its use. Specifications subject to change without notice. No license is granted by implication or otherwise under any patent or patent rights of Analog Devices. Trademarks and registered trademarks are the property of their respective owners.

For price, delivery, and to place orders: Analog Devices, Inc., One Technology Way, P.O. Box 9106, Norwood, MA 02062-9106 Phone: 781-329-4700 • Order online at [www.analog.com](http://www.analog.com) Application Support: Phone: 1-800-ANALOG-D

**GaAs MMIC SUB-HARMONICALLY PUMPED MIXER, 20 - 40 GHz**

**Conversion Gain vs. Temperature @ LO = +12 dBm**

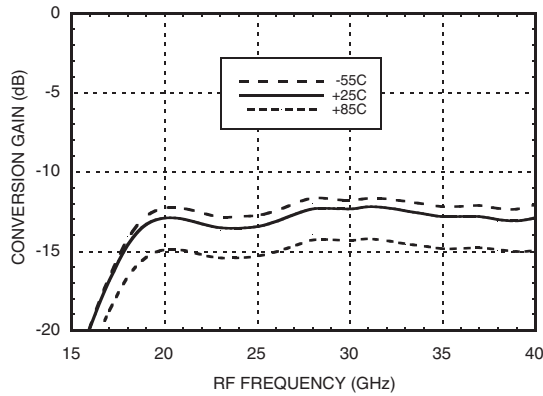

**Isolation @ LO = +12 dBm**

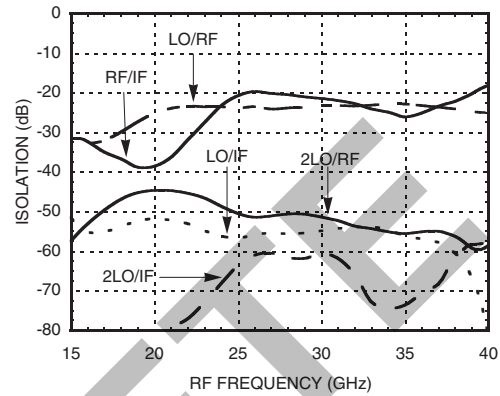

**Conversion Gain vs. LO Drive**

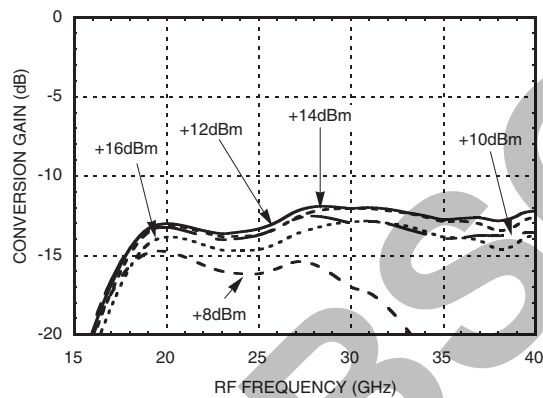

**Return Loss @ LO = +12 dBm**

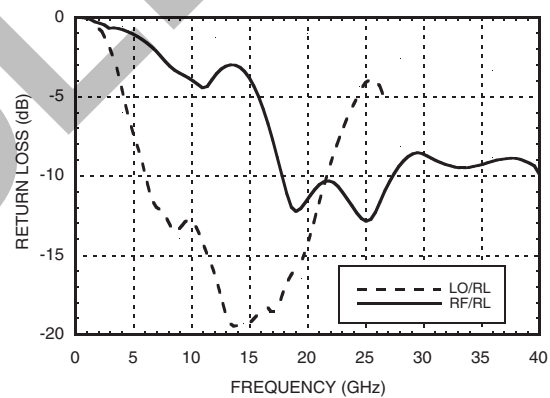

**IF Bandwidth @ LO = +12 dBm**

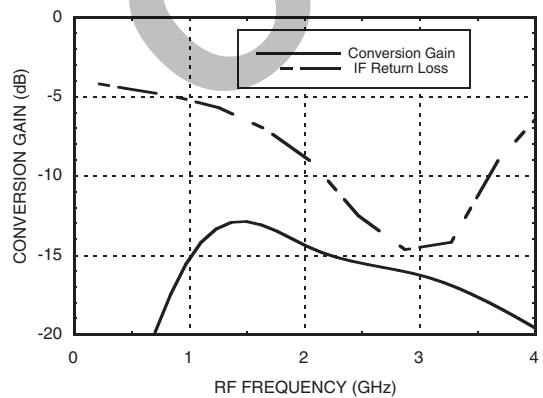

**Upconverter Performance Conversion Gain @ LO = +12 dBm**

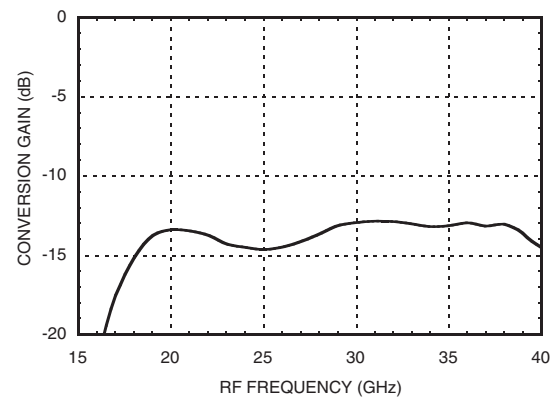

Information furnished by Analog Devices is believed to be accurate and reliable. However, no responsibility is assumed by Analog Devices for its use, nor for any infringements of patents or other rights of third parties that may result from its use. Specifications subject to change without notice. No license is granted by implication or otherwise under any patent or patent rights of Analog Devices. Trademarks and registered trademarks are the property of their respective owners.

For price, delivery, and to place orders: Analog Devices, Inc., One Technology Way, P.O. Box 9106, Norwood, MA 02062-9106 Phone: 781-329-4700 • Order online at [www.analog.com](http://www.analog.com) Application Support: Phone: 1-800-ANALOG-D

**GaAs MMIC SUB-HARMONICALLY PUMPED MIXER, 20 - 40 GHz**

**Input IP3 vs. LO Drive**

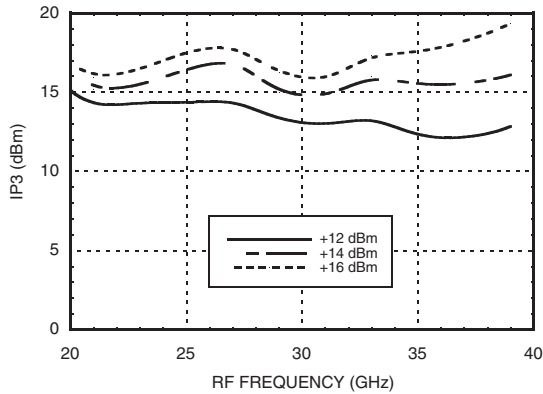

**Input IP3 vs. Temperature @ LO = +12 dBm**

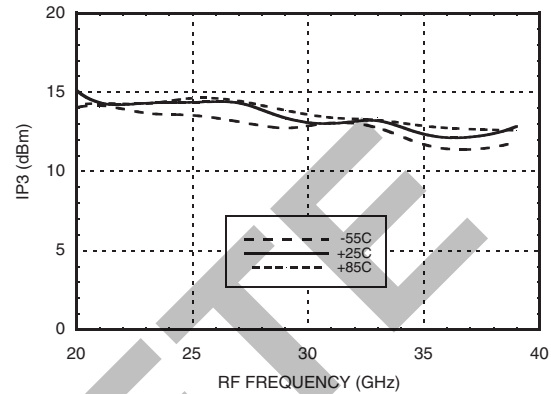

**Input IP2 vs. LO Drive**

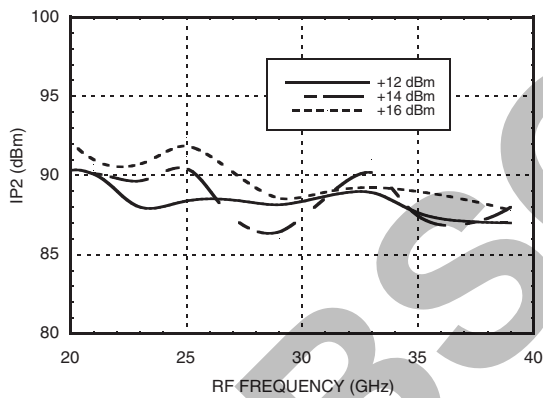

**Input IP2 vs. Temperature @ LO = +12 dBm**

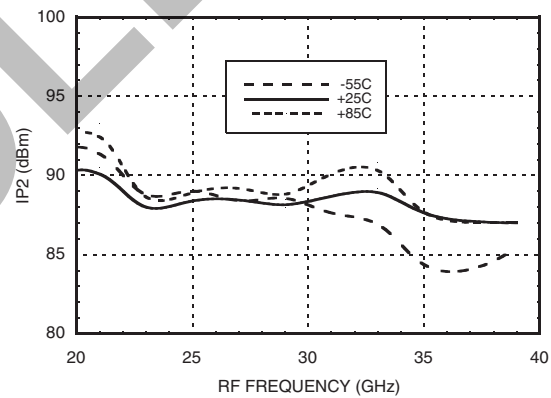

**MxN Spurious Outputs as a Down Converter**

mRF	nLO					
	±5	±4	±3	±2	±1	0
-3						
-2	67					
-1	50	29	70			
0			1	23	19	
1				x	63	6
2		63	79	66		
3		69				

RF = 27 GHz @ -10 dBm  
 LO = 13 GHz @ +12 dBm drive level  
 All values in dBc below IF power level

**P1dB vs. Temperature @ LO = +12 dBm**

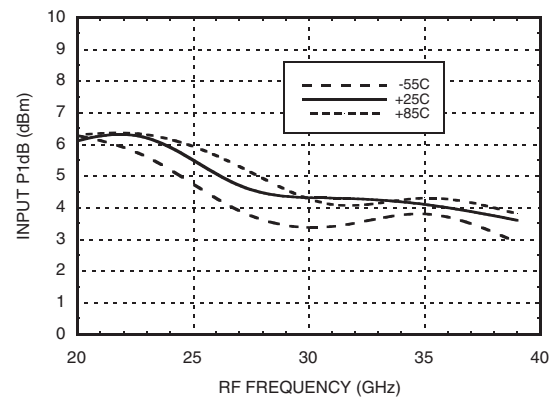

Information furnished by Analog Devices is believed to be accurate and reliable. However, no responsibility is assumed by Analog Devices for its use, nor for any infringements of patents or other rights of third parties that may result from its use. Specifications subject to change without notice. No license is granted by implication or otherwise under any patent or patent rights of Analog Devices. Trademarks and registered trademarks are the property of their respective owners.

For price, delivery, and to place orders: Analog Devices, Inc., One Technology Way, P.O. Box 9106, Norwood, MA 02062-9106 Phone: 781-329-4700 • Order online at [www.analog.com](http://www.analog.com) Application Support: Phone: 1-800-ANALOG-D

**GaAs MMIC SUB-HARMONICALLY  
PUMPED MIXER, 20 - 40 GHz**

**Absolute Maximum Ratings**

RF / IF Input	+13 dBm
LO Drive	+23 dBm
Storage Temperature	-65 to +150 °C
Operating Temperature	-55 to +85 °C



ELECTROSTATIC SENSITIVE DEVICE  
OBSERVE HANDLING PRECAUTIONS

**Outline Drawing**

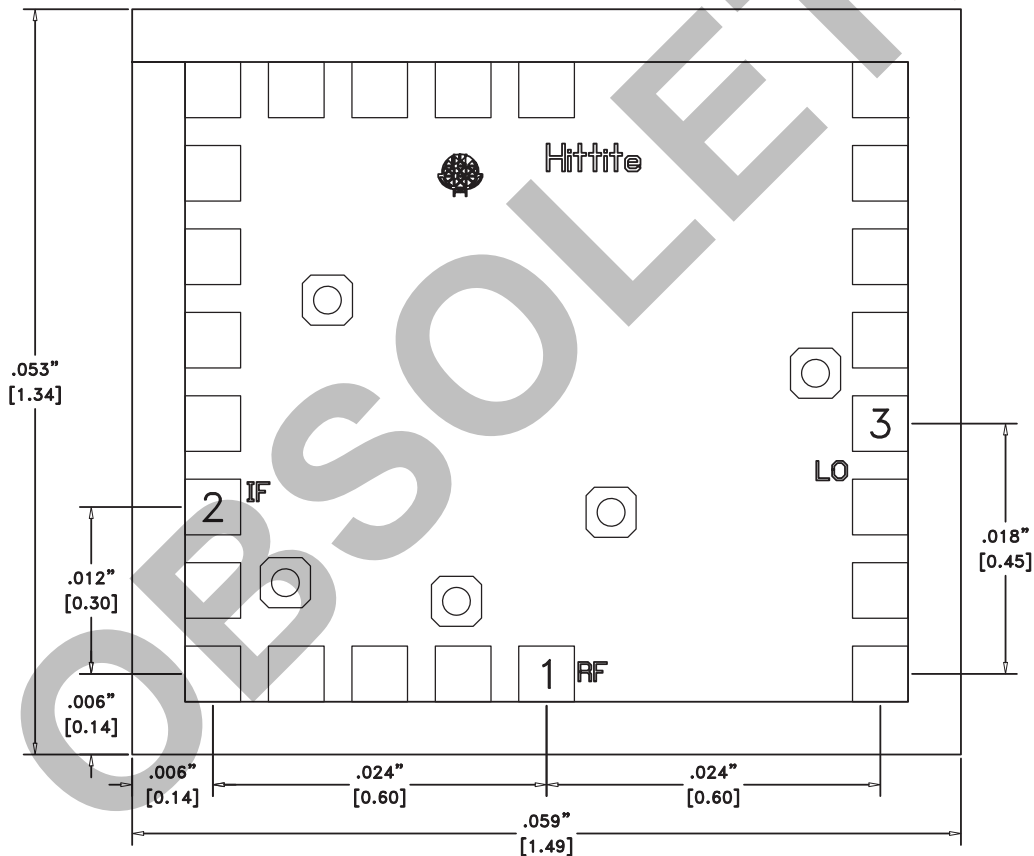

**Die Packaging Information [1]**

Standard	Alternate
WP-3 (Waffle Pack)	[2]

[1] Refer to the "Packaging Information" section for die packaging dimensions.

[2] For alternate packaging information contact Hittite Microwave Corporation.

NOTES:



1. ALL DIMENSIONS ARE IN INCHES [MM].
2. TYPICAL BOND PAD IS .004" SQUARE.
3. BOND PAD SPACING CENTER TO CENTER IS .006".
4. BACKSIDE METALLIZATION: GOLD.
5. BOND PAD METALLIZATION: GOLD.
6. BACKSIDE METAL IS GROUND.
7. CONNECTION NOT REQUIRED FOR UNLABELED BOND PADS.

Information furnished by Analog Devices is believed to be accurate and reliable. However, no responsibility is assumed by Analog Devices for its use, nor for any infringements of patents or other rights of third parties that may result from its use. Specifications subject to change without notice. No license is granted by implication or otherwise under any patent or patent rights of Analog Devices. Trademarks and registered trademarks are the property of their respective owners.

For price, delivery, and to place orders: Analog Devices, Inc., One Technology Way, P.O. Box 9106, Norwood, MA 02062-9106 Phone: 781-329-4700 • Order online at [www.analog.com](http://www.analog.com) Application Support: Phone: 1-800-ANALOG-D

## GaAs MMIC SUB-HARMONICALLY PUMPED MIXER, 20 - 40 GHz

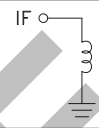
### Pad Descriptions

Pad Number	Function	Description	Interface Schematic
1	RF	This pad is AC coupled and matched to 50 Ohms.	RF 
2	IF	This pad is DC coupled and matched to 50 Ohms.	IF 
3	LO	This pad is AC coupled and matched to 50 Ohms.	LO 
Die Bottom	GND	.	GND 

OBSOLETE

Information furnished by Analog Devices is believed to be accurate and reliable. However, no responsibility is assumed by Analog Devices for its use, nor for any infringements of patents or other rights of third parties that may result from its use. Specifications subject to change without notice. No license is granted by implication or otherwise under any patent or patent rights of Analog Devices. Trademarks and registered trademarks are the property of their respective owners.

For price, delivery, and to place orders: Analog Devices, Inc., One Technology Way, P.O. Box 9106, Norwood, MA 02062-9106 Phone: 781-329-4700 • Order online at [www.analog.com](http://www.analog.com) Application Support: Phone: 1-800-ANALOG-D

## GaAs MMIC SUB-HARMONICALLY PUMPED MIXER, 20 - 40 GHz

### Mounting & Bonding Techniques for Millimeterwave GaAs MMICs

The die should be attached directly to the ground plane eutectically or with conductive epoxy (see HMC general Handling, Mounting, Bonding Note).

50 Ohm Microstrip transmission lines on 0.127mm (5 mil) thick alumina thin film substrates are recommended for bringing RF to and from the chip (Figure 1). If 0.254mm (10 mil) thick alumina thin film substrates must be used, the die should be raised 0.150mm (6 mils) so that the surface of the die is coplanar with the surface of the substrate. One way to accomplish this is to attach the 0.102mm (4 mil) thick die to a 0.150mm (6 mil) thick molybdenum heat spreader (moly-tab) which is then attached to the ground plane (Figure 2).

Microstrip substrates should be brought as close to the die as possible in order to minimize ribbon bond length. Typical die-to-substrate spacing is 0.076mm (3 mils). Gold ribbon of 0.075 mm (3 mil) width and minimal length <0.31 mm (<12 mils) is recommended to minimize inductance on RF, LO & IF ports.

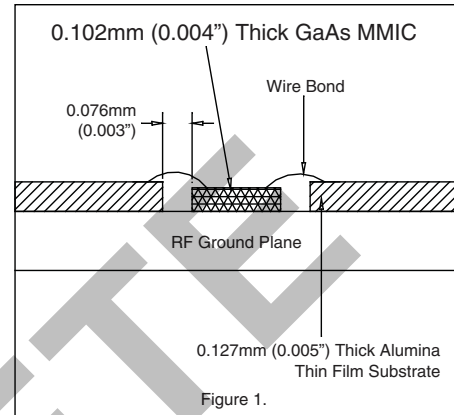

### Handling Precautions

Follow these precautions to avoid permanent damage.

**Storage:** All bare die are placed in either Waffle or Gel based ESD protective containers, and then sealed in an ESD protective bag for shipment. Once the sealed ESD protective bag has been opened, all die should be stored in a dry nitrogen environment.

**Cleanliness:** Handle the chips in a clean environment. DO NOT attempt to clean the chip using liquid cleaning systems.

**Static Sensitivity:** Follow ESD precautions to protect against ESD strikes.

**Transients:** Suppress instrument and bias supply transients while bias is applied. Use shielded signal and bias cables to minimize inductive pick-up.

**General Handling:** Handle the chip along the edges with a vacuum collet or with a sharp pair of bent tweezers. The surface of the chip has fragile air bridges and should not be touched with vacuum collet, tweezers, or fingers.

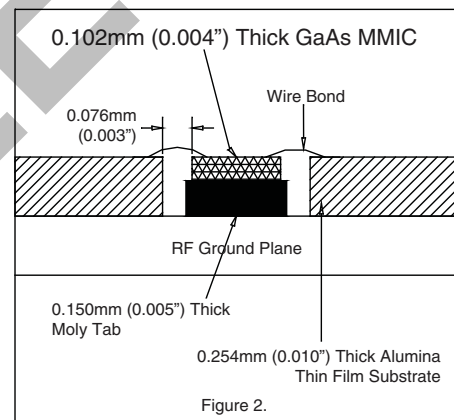

### Mounting

The chip is back-metallized and can be die mounted with AuSn eutectic preforms or with electrically conductive epoxy. The mounting surface should be clean and flat.

**Eutectic Die Attach:** A 80/20 gold tin preform is recommended with a work surface temperature of 255 °C and a tool temperature of 265 °C. When hot 90/10 nitrogen/hydrogen gas is applied, tool tip temperature should be 290 °C. DO NOT expose the chip to a temperature greater than 320 °C for more than 20 seconds. No more than 3 seconds of scrubbing should be required for attachment.

**Epoxy Die Attach:** Apply a minimum amount of epoxy to the mounting surface so that a thin epoxy fillet is observed around the perimeter of the chip once it is placed into position. Cure epoxy per the manufacturer's schedule.

### Wire Bonding

RF bonds made with 0.003" x 0.0005" ribbon are recommended. These bonds should be thermosonically bonded with a force of 40-60 grams. DC bonds of 0.001" (0.025 mm) diameter, thermosonically bonded, are recommended. Ball bonds should be made with a force of 40-50 grams and wedge bonds at 18-22 grams. All bonds should be made with a nominal stage temperature of 150 °C. A minimum amount of ultrasonic energy should be applied to achieve reliable bonds. All bonds should be as short as possible, less than 12 mils (0.31 mm).