



BZX585 series

Voltage regulator diodes

Rev. 5 — 11 October 2016

Product data sheet

1. Product profile

1.1 General description

General-purpose Zener diodes in an SOD523 (SC-79) ultra small and flat lead Surface-Mounted Device (SMD) plastic package.

1.2 Features and benefits

- Non-repetitive peak reverse power dissipation: ≤ 40 W
- Total power dissipation: ≤ 300 mW
- AEC-Q101 qualified
- Wide working voltage range: nominal 2.4 V to 75 V (E24 range)
- Two tolerance series: $\pm 2\%$ and $\pm 5\%$
- Low differential resistance

1.3 Applications

- General regulation functions

1.4 Quick reference data

Table 1. Quick reference data

Symbol	Parameter	Conditions	Min	Typ	Max	Unit
V_F	forward voltage	$I_F = 100$ mA	[1]	-	1.1	V
P_{ZSM}	non-repetitive peak reverse power dissipation		[2]	-	40	W

[1] Pulse test: $t_p \leq 300$ μ s; $\delta \leq 0.02$.

[2] $t_p = 100$ μ s; square wave; $T_j = 25$ °C before surge

2. Pinning information

Table 2. Pinning

Pin	Description	Simplified outline	Graphic symbol
1	cathode [1]		
2	anode		

[1] The marking bar indicates the cathode.

3. Ordering information

Table 3. Ordering information

Type number	Package		
	Name	Description	Version
BZX585-B2V4 to BZX585-C75 ^[1]	SC-79	plastic surface-mounted package; 2 leads	SOD523

[1] The series consists of 74 types with nominal working voltages from 2.4 V to 75 V.

4. Marking

Table 4. Marking codes

Type number	Marking code	Type number	Marking code	Type number	Marking code	Type number	Marking code
BZX585-B2V4	C1	BZX585-B15	E0	BZX585-C2V4	F1	BZX585-C15	H0
BZX585-B2V7	C2	BZX585-B16	EA	BZX585-C2V7	F2	BZX585-C16	HA
BZX585-B3V0	C3	BZX585-B18	EB	BZX585-C3V0	F3	BZX585-C18	HB
BZX585-B3V3	C4	BZX585-B20	EC	BZX585-C3V3	F4	BZX585-C20	HC
BZX585-B3V6	C5	BZX585-B22	ED	BZX585-C3V6	F5	BZX585-C22	HD
BZX585-B3V9	C6	BZX585-B24	EE	BZX585-C3V9	F6	BZX585-C24	HE
BZX585-B4V3	C7	BZX585-B27	EF	BZX585-C4V3	F7	BZX585-C27	HF
BZX585-B4V7	C8	BZX585-B30	EG	BZX585-C4V7	F8	BZX585-C30	HG
BZX585-B5V1	C9	BZX585-B33	EH	BZX585-C5V1	F9	BZX585-C33	HH
BZX585-B5V6	C0	BZX585-B36	EK	BZX585-C5V6	F0	BZX585-C36	HK
BZX585-B6V2	E1	BZX585-B39	EL	BZX585-C6V2	H1	BZX585-C39	HL
BZX585-B6V8	E2	BZX585-B43	EM	BZX585-C6V8	H2	BZX585-C43	HM
BZX585-B7V5	E3	BZX585-B47	EN	BZX585-C7V5	H3	BZX585-C47	HN
BZX585-B8V2	E4	BZX585-B51	EP	BZX585-C8V2	H4	BZX585-C51	HP
BZX585-B9V1	E5	BZX585-B56	ER	BZX585-C9V1	H5	BZX585-C56	HR
BZX585-B10	E6	BZX585-B62	ES	BZX585-C10	H6	BZX585-C62	HS
BZX585-B11	E7	BZX585-B68	ET	BZX585-C11	H7	BZX585-C68	HT
BZX585-B12	E8	BZX585-B75	EU	BZX585-C12	H8	BZX585-C75	HU
BZX585-B13	E9	-	-	BZX585-C13	H9	-	-

5. Limiting values

Table 5. Limiting values

In accordance with the Absolute Maximum Rating System (IEC 60134).

Symbol	Parameter	Conditions	Min	Max	Unit
I_F	forward current		-	200	mA
I_{ZSM}	non-repetitive peak reverse current		[1] -	see Table 8 and 9	
P_{ZSM}	non-repetitive peak reverse power dissipation		[1] -	40	W
P_{tot}	total power dissipation	$T_{amb} \leq 25\text{ °C}$	[2] -	300	mW
T_{amb}	ambient temperature		-65	+150	°C
T_j	junction temperature		-65	+150	°C
T_{stg}	storage temperature		-65	+150	°C

[1] $t_p = 100\ \mu\text{s}$; square wave; $T_j = 25\text{ °C}$ before surge

[2] Device mounted on an FR4 Printed-Circuit Board (PCB) with approximately 35 mm² Cu area at cathode tab.

6. Thermal characteristics

Table 6. Thermal characteristics

Symbol	Parameter	Conditions	Min	Typ	Max	Unit
$R_{th(j-a)}$	thermal resistance from junction to ambient	in free air	[1] -	-	350	K/W
$R_{th(j-sp)}$	thermal resistance from junction to solder point		[2] -	-	65	K/W

[1] Device mounted on an FR4 Printed-Circuit Board (PCB) with approximately 35 mm² Cu area at cathode tab.

[2] Soldering point of cathode tab.

7. Characteristics

Table 7. Characteristics

$T_j = 25\text{ °C}$ unless otherwise specified.

Symbol	Parameter	Conditions	Min	Typ	Max	Unit
V_F	forward voltage		[1]			
		$I_F = 10\text{ mA}$	-	-	0.9	V
		$I_F = 100\text{ mA}$	-	-	1.1	V

[1] Pulse test: $t_p \leq 300\ \mu\text{s}$; $\delta \leq 0.02$.

Table 8. Characteristics per type; BZX585-B2V4 to BZX585-C24

 $T_j = 25\text{ }^\circ\text{C}$ unless otherwise specified.

BZX585-xxx	Sel	Working voltage V_Z (V)		Differential resistance r_{dif} (Ω)				Reverse current I_R (μA)		Temperature coefficient S_Z (mV/K)			Diode capacitance C_d (pF) ^[1]	Non-repetitive peak reverse current I_{ZSM} (A) ^[2]
		$I_Z = 5\text{ mA}$		$I_Z = 1\text{ mA}$		$I_Z = 5\text{ mA}$		Max	V_R (V)	$I_Z = 5\text{ mA}$				
		Min	Max	Typ	Max	Typ	Max			Min	Typ	Max		
2V4	B	2.35	2.45	275	400	70	100	50	1	-3.5	-1.3	0	450	6
	C	2.28	2.52											
2V7	B	2.65	2.75	300	450	75	100	20	1	-3.5	-1.4	0	440	6
	C	2.57	2.84											
3V0	B	2.94	3.06	325	500	80	95	10	1	-3.5	-1.6	0	425	6
	C	2.85	3.15											
3V3	B	3.23	3.37	350	500	85	95	5	1	-3.5	-1.8	0	410	6
	C	3.14	3.47											
3V6	B	3.53	3.67	375	500	85	90	5	1	-3.5	-1.9	0	390	6
	C	3.42	3.78											
3V9	B	3.82	3.98	400	500	85	90	3	1	-3.5	-1.9	0	370	6
	C	3.71	4.10											
4V3	B	4.21	4.39	410	600	80	90	3	1	-3.5	-1.7	0	350	6
	C	4.09	4.52											
4V7	B	4.61	4.79	425	500	50	80	3	2	-3.5	-1.2	0.2	325	6
	C	4.47	4.94											
5V1	B	5.00	5.20	400	480	40	60	2	2	-2.7	-0.5	1.2	300	6
	C	4.85	5.36											
5V6	B	5.49	5.71	80	400	15	40	1	2	-2	1.0	2.5	275	6
	C	5.32	5.88											
6V2	B	6.08	6.32	40	150	6	10	3	4	0.4	2.2	3.7	250	6
	C	5.89	6.51											
6V8	B	6.66	6.94	30	80	6	15	2	4	1.2	3.0	4.5	215	6
	C	6.46	7.14											
7V5	B	7.35	7.65	15	80	2	10	1	5	2.5	3.6	5.3	170	4
	C	7.13	7.88											
8V2	B	8.04	8.36	20	80	2	10	0.7	5	3.2	4.3	6.2	150	4
	C	7.79	8.61											
9V1	B	8.92	9.28	20	100	2	10	0.5	6	3.8	5.2	7	120	3
	C	8.65	9.56											
10	B	9.80	10.20	20	150	2	10	0.2	7	4.5	6.0	8	110	3
	C	9.50	10.50											
11	B	10.78	11.22	25	150	2	10	0.1	8	5.4	6.9	9	110	2.5
	C	10.45	11.55											
12	B	11.76	12.24	25	150	2	10	0.1	8	6	7.9	10	105	2.5
	C	11.40	12.60											

Table 8. Characteristics per type; BZX585-B2V4 to BZX585-C24 ...continued $T_j = 25\text{ °C}$ unless otherwise specified.

BZX585-xxx	Sel	Working voltage V_Z (V)		Differential resistance r_{dif} (Ω)				Reverse current I_R (μ A)		Temperature coefficient S_Z (mV/K)			Diode capacitance C_d (pF) ^[1]	Non-repetitive peak reverse current I_{ZSM} (A) ^[2]
				$I_Z = 1\text{ mA}$		$I_Z = 5\text{ mA}$				$I_Z = 5\text{ mA}$				
		Min	Max	Typ	Max	Typ	Max	Max	V_R (V)	Min	Typ	Max		
13	B	12.74	13.26	25	170	2	10	0.1	8	7	8.8	11	105	2.5
	C	12.35	13.65											
15	B	14.70	15.30	25	200	3	15	0.05	10.5	9.2	10.7	13	100	2
	C	14.25	15.75											
16	B	15.68	16.32	50	200	10	40	0.05	11.2	10.4	12.4	14	90	1.5
	C	15.20	16.80											
18	B	17.64	18.36	50	225	10	45	0.05	12.6	12.4	14.4	16	80	1.5
	C	17.10	18.90											
20	B	19.60	20.40	60	225	15	55	0.05	14	14.4	16.4	18	70	1.5
	C	19.00	21.00											
22	B	21.56	22.44	60	250	20	55	0.05	15.4	16.4	18.4	20	60	1.25
	C	20.90	23.10											
24	B	23.52	24.48	60	250	25	70	0.05	16.8	18.4	20.4	22	55	1.25
	C	22.80	25.20											

[1] $f = 1\text{ MHz}$; $V_R = 0\text{ V}$ [2] $t_p = 100\text{ }\mu\text{s}$; square wave; $T_j = 25\text{ °C}$ before surge

Table 9. Characteristics per type; BZX585-B27 to BZX585-C75 $T_j = 25\text{ °C}$ unless otherwise specified.

BZX585 -xxx	Sel	Working voltage V_Z (V)		Differential resistance r_{dif} (Ω)				Reverse current I_R (μ A)		Temperature coefficient S_Z (mV/K)			Diode capacitance C_d (pF) ^[1]	Non-repetitive peak reverse current I_{ZSM} (A) ^[2]
		$I_Z = 2\text{ mA}$		$I_Z = 0.5\text{ mA}$		$I_Z = 2\text{ mA}$		Max	V_R (V)	$I_Z = 2\text{ mA}$				
		Min	Max	Typ	Max	Typ	Max			Min	Typ	Max		
27	B	26.46	27.54	65	300	25	80	0.05	18.9	21.4	23.4	25.3	50	1.0
	C	25.65	28.35											
30	B	29.40	30.60	70	300	30	80	0.05	21	24.4	26.6	29.4	50	1.0
	C	28.50	31.50											
33	B	32.34	33.66	75	325	35	80	0.05	23.1	27.4	29.7	33.4	45	0.9
	C	31.35	34.65											
36	B	35.28	36.72	80	350	35	90	0.05	25.2	30.4	33.0	37.4	45	0.8
	C	34.20	37.80											
39	B	38.22	39.78	80	350	40	130	0.05	27.3	33.4	36.4	41.2	45	0.7
	C	37.05	40.95											
43	B	42.14	43.86	85	375	45	150	0.05	30.1	37.6	41.2	46.6	40	0.6
	C	40.85	45.15											
47	B	46.06	47.94	85	375	50	170	0.05	32.9	42.0	46.1	51.8	40	0.5
	C	44.65	49.35											
51	B	49.98	52.02	90	400	60	180	0.05	35.7	46.6	51.0	57.2	40	0.4
	C	48.45	53.55											
56	B	54.88	57.12	100	425	70	200	0.05	39.2	52.2	57.0	63.8	40	0.3
	C	53.20	58.80											
62	B	60.76	63.24	120	450	80	215	0.05	43.4	58.8	64.4	71.6	35	0.3
	C	58.90	65.10											
68	B	66.64	69.36	150	475	90	240	0.05	47.6	65.6	71.7	79.8	35	0.25
	C	64.60	71.40											
75	B	73.50	76.50	170	500	95	255	0.05	52.5	73.4	80.2	88.6	35	0.2
	C	71.25	78.75											

[1] $f = 1\text{ MHz}$; $V_R = 0\text{ V}$ [2] $t_p = 100\text{ }\mu\text{s}$; square wave; $T_j = 25\text{ °C}$ before surge

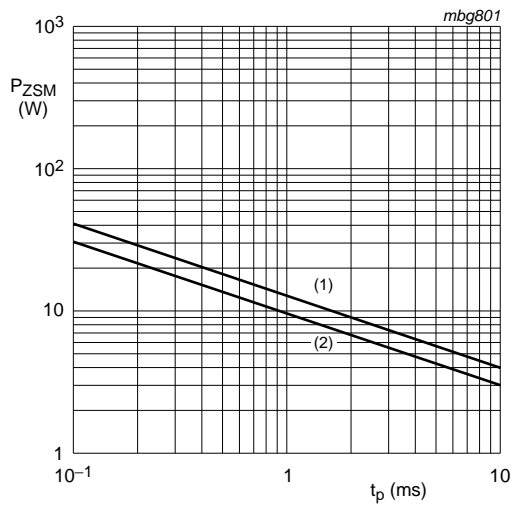

- (1) $T_j = 25\text{ °C}$ (before surge)
- (2) $T_j = 150\text{ °C}$ (before surge)

Fig 1. Non-repetitive peak reverse power dissipation as a function of pulse duration; maximum values

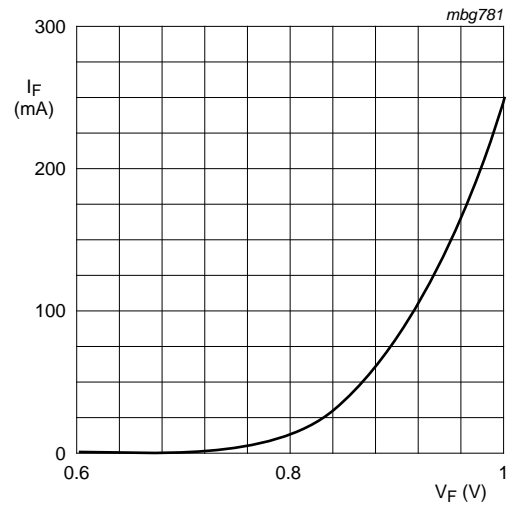

$T_j = 25\text{ °C}$

Fig 2. Forward current as a function of forward voltage; typical values

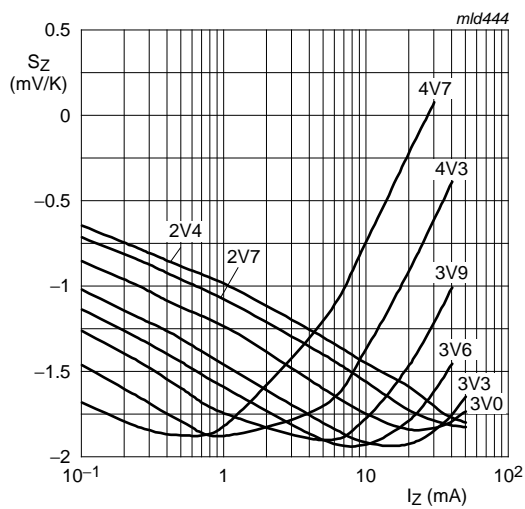

BZX585-B/C2V4 to BZX585-B/C4V7
 $T_j = 25\text{ °C}$ to 150 °C

Fig 3. Temperature coefficient as a function of working current; typical values

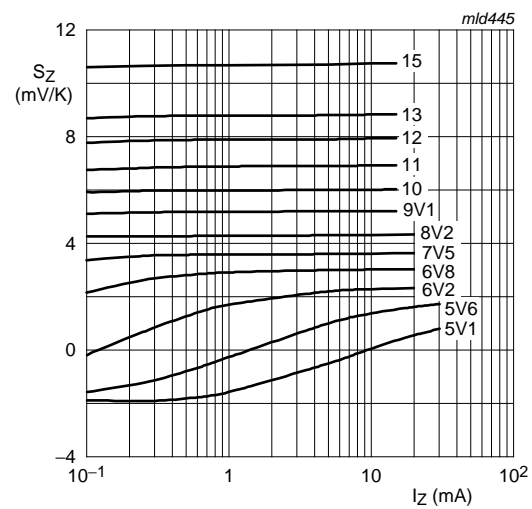

BZX585-B/C5V1 to BZX585-B/C15
 $T_j = 25\text{ °C}$ to 150 °C

Fig 4. Temperature coefficient as a function of working current; typical values

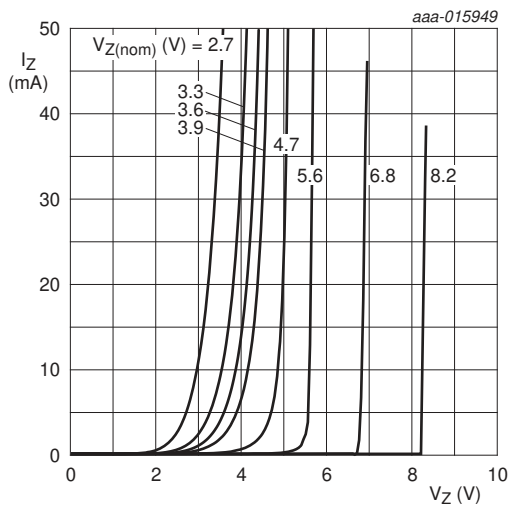

$T_j = 25\text{ }^\circ\text{C}$
BZX585-B/C2V7 to BZX585-B/C8V2

Fig 5. Working current as a function of working voltage; typical values

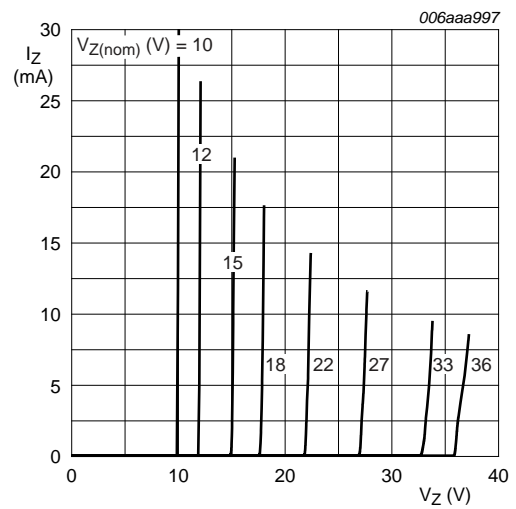

$T_j = 25\text{ }^\circ\text{C}$
BZX585-B/C10 to BZX585-B/C36

Fig 6. Working current as a function of working voltage; typical values

8. Test information

8.1 Quality information

This product has been qualified in accordance with the Automotive Electronics Council (AEC) standard *Q101 - Stress test qualification for discrete semiconductors*, and is suitable for use in automotive applications.

9. Package outline

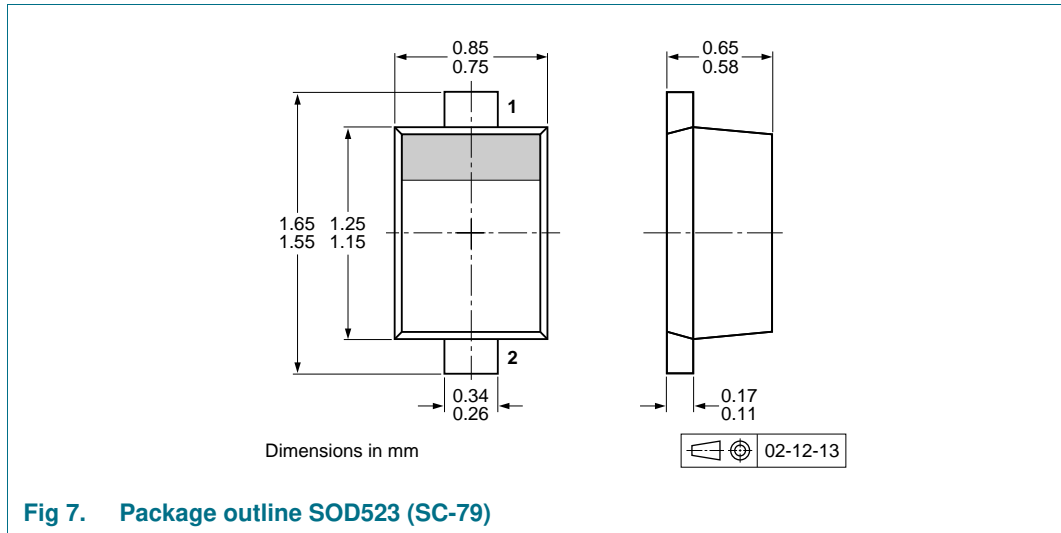

10. Soldering

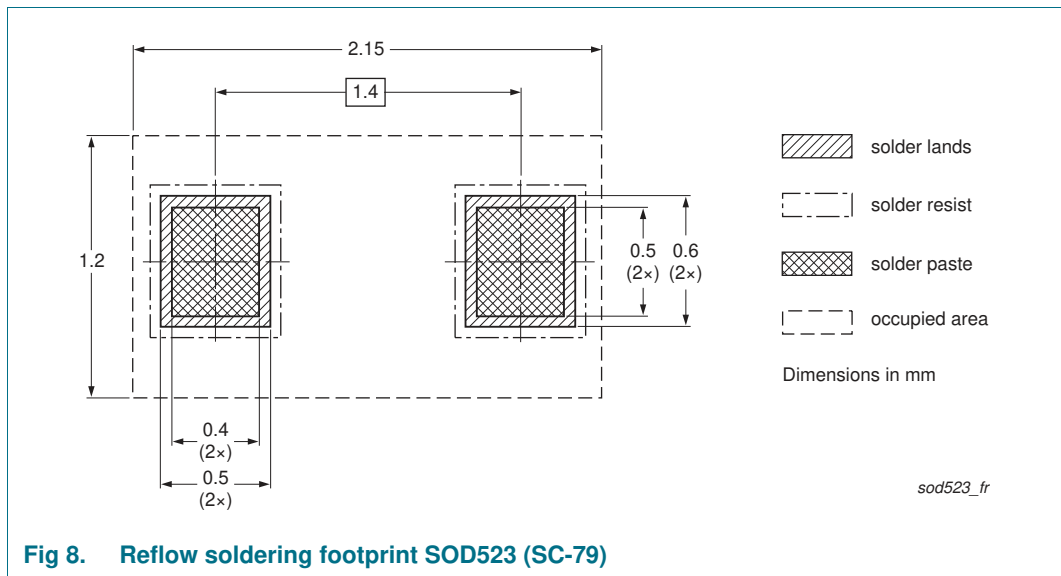

11. Revision history

Table 10. Revision history

Document ID	Release date	Data sheet status	Change notice	Supersedes
BZX585_SER v.5	20161011	Product data sheet	-	BZX585_SER v.4
Modifications:	<ul style="list-style-type: none"> • The format of this document has been redesigned to comply with the new identity guidelines of NXP Semiconductors • Legal texts have been adapted to the new company name where appropriate. • Section 1 "Product profile": enhanced. • Table 5: T_{amb} added. • Table 8 and Table 9: updated • Figure 1, Figure 5 and Figure 6: added • Section 8 "Test information": added. • Figure 7: replaced by minimized package outline • Section 10 "Soldering": added • Section 12 "Legal information": updated 			
BZX585_SER v.4	20040622	Product data sheet	-	BZX585_SER v.3
BZX585_SER v.3	20040326	Product specification	-	BZX585_SER v.2
BZX585_SER v.2	20001020	Product specification	-	BZX585_SER v.1
BZX585_SER v.1	20000606	Product specification	-	-

12. Legal information

12.1 Data sheet status

Document status ^{[1][2]}	Product status ^[3]	Definition
Objective [short] data sheet	Development	This document contains data from the objective specification for product development.
Preliminary [short] data sheet	Qualification	This document contains data from the preliminary specification.
Product [short] data sheet	Production	This document contains the product specification.

[1] Please consult the most recently issued document before initiating or completing a design.

[2] The term 'short data sheet' is explained in section "Definitions".

[3] The product status of device(s) described in this document may have changed since this document was published and may differ in case of multiple devices. The latest product status information is available on the Internet at URL <http://www.nexperia.com>.

12.2 Definitions

Draft — The document is a draft version only. The content is still under internal review and subject to formal approval, which may result in modifications or additions. Nexperia does not give any representations or warranties as to the accuracy or completeness of information included herein and shall have no liability for the consequences of use of such information.

Short data sheet — A short data sheet is an extract from a full data sheet with the same product type number(s) and title. A short data sheet is intended for quick reference only and should not be relied upon to contain detailed and full information. For detailed and full information see the relevant full data sheet, which is available on request via the local Nexperia sales office. In case of any inconsistency or conflict with the short data sheet, the full data sheet shall prevail.

Product specification — The information and data provided in a Product data sheet shall define the specification of the product as agreed between Nexperia and its customer, unless Nexperia and customer have explicitly agreed otherwise in writing. In no event however, shall an agreement be valid in which the Nexperia product is deemed to offer functions and qualities beyond those described in the Product data sheet.

12.3 Disclaimers

Limited warranty and liability — Information in this document is believed to be accurate and reliable. However, Nexperia does not give any representations or warranties, expressed or implied, as to the accuracy or completeness of such information and shall have no liability for the consequences of use of such information. Nexperia takes no responsibility for the content in this document if provided by an information source outside of Nexperia.

In no event shall Nexperia be liable for any indirect, incidental, punitive, special or consequential damages (including - without limitation - lost profits, lost savings, business interruption, costs related to the removal or replacement of any products or rework charges) whether or not such damages are based on tort (including negligence), warranty, breach of contract or any other legal theory.

Notwithstanding any damages that customer might incur for any reason whatsoever, Nexperia's aggregate and cumulative liability towards customer for the products described herein shall be limited in accordance with the *Terms and conditions of commercial sale* of Nexperia.

Right to make changes — Nexperia reserves the right to make changes to information published in this document, including without limitation specifications and product descriptions, at any time and without notice. This document supersedes and replaces all information supplied prior to the publication hereof.

Suitability for use in automotive applications — This Nexperia

product has been qualified for use in automotive applications. Unless otherwise agreed in writing, the product is not designed, authorized or warranted to be suitable for use in life support, life-critical or safety-critical systems or equipment, nor in applications where failure or malfunction of a Nexperia product can reasonably be expected to result in personal injury, death or severe property or environmental damage. Nexperia and its suppliers accept no liability for inclusion and/or use of Nexperia products in such equipment or applications and therefore such inclusion and/or use is at the customer's own risk.

Applications — Applications that are described herein for any of these products are for illustrative purposes only. Nexperia makes no representation or warranty that such applications will be suitable for the specified use without further testing or modification.

Customers are responsible for the design and operation of their applications and products using Nexperia products, and Nexperia accepts no liability for any assistance with applications or customer product design. It is customer's sole responsibility to determine whether the Nexperia product is suitable and fit for the customer's applications and products planned, as well as for the planned application and use of customer's third party customer(s). Customers should provide appropriate design and operating safeguards to minimize the risks associated with their applications and products.

Nexperia does not accept any liability related to any default, damage, costs or problem which is based on any weakness or default in the customer's applications or products, or the application or use by customer's third party customer(s). Customer is responsible for doing all necessary testing for the customer's applications and products using Nexperia products in order to avoid a default of the applications and the products or of the application or use by customer's third party customer(s). Nexperia does not accept any liability in this respect.

Limiting values — Stress above one or more limiting values (as defined in the Absolute Maximum Ratings System of IEC 60134) will cause permanent damage to the device. Limiting values are stress ratings only and (proper) operation of the device at these or any other conditions above those given in the Recommended operating conditions section (if present) or the Characteristics sections of this document is not warranted. Constant or repeated exposure to limiting values will permanently and irreversibly affect the quality and reliability of the device.

Terms and conditions of commercial sale — Nexperia products are sold subject to the general terms and conditions of commercial sale, as published at <http://www.nexperia.com/profile/terms>, unless otherwise agreed in a valid written individual agreement. In case an individual agreement is concluded only the terms and conditions of the respective agreement shall apply. Nexperia hereby expressly objects to applying the customer's general terms and conditions with regard to the purchase of Nexperia products by customer.

No offer to sell or license — Nothing in this document may be interpreted or construed as an offer to sell products that is open for acceptance or the grant, conveyance or implication of any license under any copyrights, patents or other industrial or intellectual property rights.

Export control — This document as well as the item(s) described herein may be subject to export control regulations. Export might require a prior authorization from competent authorities.

Quick reference data — The Quick reference data is an extract of the product data given in the Limiting values and Characteristics sections of this document, and as such is not complete, exhaustive or legally binding.

Translations — A non-English (translated) version of a document is for reference only. The English version shall prevail in case of any discrepancy between the translated and English versions.

12.4 Trademarks

Notice: All referenced brands, product names, service names and trademarks are the property of their respective owners.

13. Contact information

For more information, please visit: <http://www.nexperia.com>

For sales office addresses, please send an email to: salesaddresses@nexperia.com

14. Contents

1	Product profile	1
1.1	General description	1
1.2	Features and benefits	1
1.3	Applications	1
1.4	Quick reference data	1
2	Pinning information	1
3	Ordering information	2
4	Marking	2
5	Limiting values	3
6	Thermal characteristics	3
7	Characteristics	3
8	Test information	8
8.1	Quality information	8
9	Package outline	9
10	Soldering	9
11	Revision history	10
12	Legal information	11
12.1	Data sheet status	11
12.2	Definitions	11
12.3	Disclaimers	11
12.4	Trademarks	12
13	Contact information	12
14	Contents	13