

# K21MC7-P04LJG0-657S medi\_snap, type\_k2

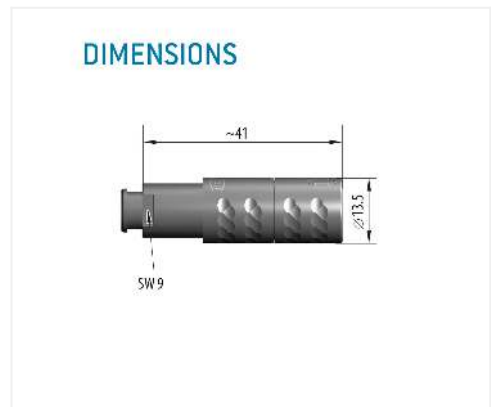

## General information

Part number	K21MC7-P04LJG0-657S
Termination	solder
Size	1
Locking principle	break , push
Coding	c_key_medi
Cable Diameter	cable_medi_65
Cable outlet	bend_relief



## Contact insert description

Number of contacts	4
Contact type	sockets
Contact diameter	09mm
Insulator material	peek
Wire cross section	22_awg
Termination	solder
Termination diameter	085mm

reverse\_gender\_on\_request

## Technical information

Max. creepage and air clearance distance	12_mm	
Nominal current single contact	075_a	iec_60512_5_2
Nominal current insert	7,5 A	vde_0298_4
Test voltage	19_kv_dc	sae_13441

safety\_text

## Mechanical and environmental data

Degree of protection*	ip50
-----------------------	------

Operating temperature	50_120_c
-----------------------	----------

Mating cycles	5000
---------------	------

mated\_unmated

## Insulator materials MEDI-SNAP®

psu\_peek

## Material and surface treatments

Housing	psu_gray
---------	----------

Color option	gray
--------------	------

Contact	cu_alloy_gold
---------	---------------

safety\_text\_2

ul\_text

illustrative\_text