

0.5mm Pitch  
Board to Board Connector

# 5046 5047 Series

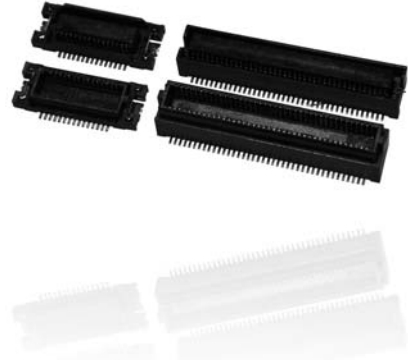

シリーズ (Series)	5046 / 5047
基板間高さ (Stacking Height)	5046; 3.0/3.5/4.0/4.5mm 5047; 5.0/7.0mm
極間隔 (Pitch)	0.5mm
極数 (No. of Positions)	5046; 20 to 120 Pos. 5047; 20 to 100 Pos.
定格電流 (Rated Current)	DC 0.4A/Contact
定格電圧 (Rated Voltage)	DC 50V/Contact
耐電圧 (D. W. Voltage)	AC 500Vrms/min.
コンタクト材質 (Contact Material)	銅合金 (Copper alloy)
インシュレータ材質 (Insulator Material)	耐熱樹脂 (Heat-resistant plastic)
使用温度範囲 (Operating Temperature)	-25 to +85°C



#### ◆概要

5046 / 5047 シリーズは、嵌合時の基板間隔 3.0mm ~ 7.0mm に対応した基板対基板コネクタです。独自のコネクティングシステムを採用し、超小型ながらクリック感のある確実な嵌合、高信頼性を可能にしました。自動実装に対応する設計構造、エンボステープ入りでお届けします。また、吸着テープ付仕様の選択も可能です。

#### ◆特長

- (1) 嵌合部のこじりに強い設計構造で、自然落下時の衝撃にも大きな信頼性を実現しています。
- (2) 800 もしくは 1,000 個入りのエンボステープ梱包でお届けします。
- (3) 環境に優しい RoHS 指令対応品です。

#### ◆Outline

The 5046 and 5047 Series are stacking heights range from 3.0mm to 7.0mm. These series feature Kyocera Connector Products' original receptacle contacts, realizing secure mating with a fine "click" feeling and high reliability. Designed for automatic mounting machines, packaged in tape and reel.

#### ◆Features

- (1) Designed to have the strong resistance against torque forces on mating area to achieve the high reliability in the natural fall shock.
- (2) Packaged in tape and reel: 800 or 1,000 pieces/reel.
- (3) RoHS compliant product.

本カタログには推奨めっきを掲載しております。めっき種類・仕様、ならびに生産対応可能極数については営業部にご確認願います。  
Recommended plating types are mentioned in this catalogue. For other plating types and their specifications, and available numbers of positions, please feel free to contact our sales department.

# 0.5mm Pitch 5047 Series

0.5mm ピッチ 嵌合高さ 5.0/7.0mm SMT 20 ~ 120 極  
0.5mm Pitch, Stacking Height=5.0/7.0mm, SMT, 20 to 120 positions

## ● Plug

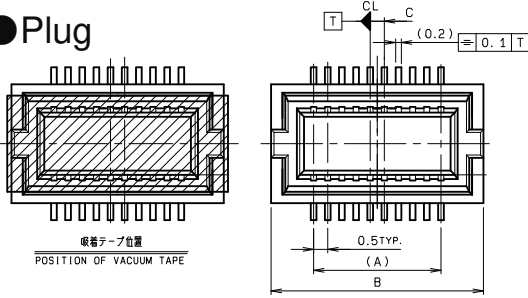

■ 5.0mm type

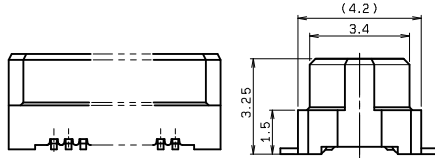

■ 7.0mm type

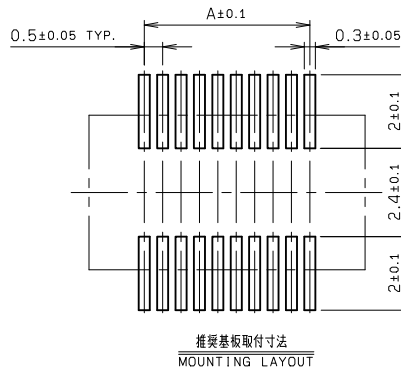
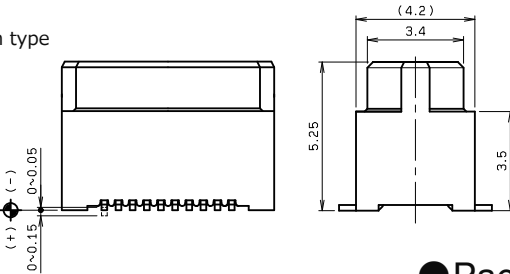

極数 NO. OF POS.	A	B	C
20	4.5	7.5	0.25
30	7.0	10.0	0.50
40	9.5	12.5	0.25
50	12.0	15.0	0.50
60	14.5	17.5	0.25
70	17.0	20.0	0.50
80	19.5	22.5	0.25
90	22.0	25.0	0.50
100	24.5	27.5	0.25
110	27.0	30.0	0.50
120	29.5	32.5	0.25

## ● Receptacle

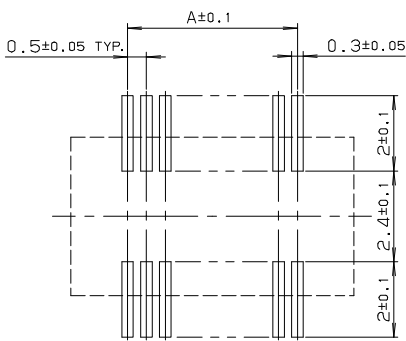
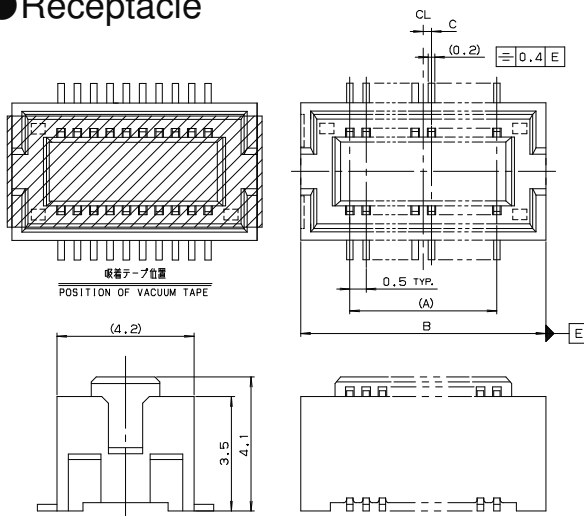

## ● Packaging

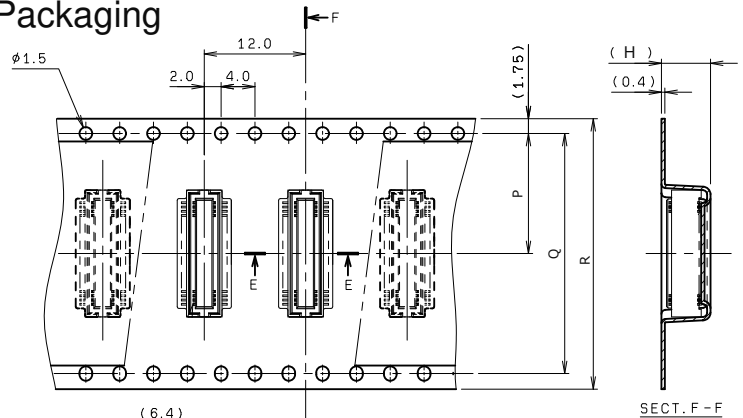

嵌合高さ Stacking Height	H
Plug(5.0mm)	4.8
Plug(7.0mm)	6.8
Receptacle	5.8

極数 NO. OF POS.	P	Q	R
20	14.2	28.4	32.0
30	14.2	28.4	32.0
40	14.2	28.4	32.0
50	14.2	28.4	32.0
60	14.2	28.4	32.0
70	20.2	40.4	44.0
80	20.2	40.4	44.0
90	20.2	40.4	44.0
100	20.2	40.4	44.0
110	20.2	40.4	44.0
120	20.2	40.4	44.0

### 注文コード/Ordering Code

Plug

Part No. 14 5047 XXX XX0 829+

極数 No. of Pos.

5: 嵌合高さ (Stacking Height) 5.0mm

7: 嵌合高さ (Stacking Height) 7.0mm

4: 吸着テープ無 Without vacuum tape

9: 吸着テープ付 With vacuum tape

Receptacle

Part No. 24 5047 XXX X00 829+

極数 No. of Pos.

4: 吸着テープ無 Without vacuum tape

9: 吸着テープ付 With vacuum tape

RoHS 対応品  
RoHS Compliant Product

梱包数量: 800個/リール  
PACKING QUANTITY: 800/Reel

本カタログには推奨めっきを掲載しております。めっき種類・仕様、ならびに生産対応可能極数については営業部にご確認ください。  
Recommended plating types are mentioned in this catalogue. For other plating types and their specifications, and available numbers of positions, please feel free to contact our sales department.