

SPECIFICATIONS

"Preliminary data"



Model Number: CR3512MB-G50
Part Number: 17000200A

Version: Apr 11, 2017

Mechanical Drawing:

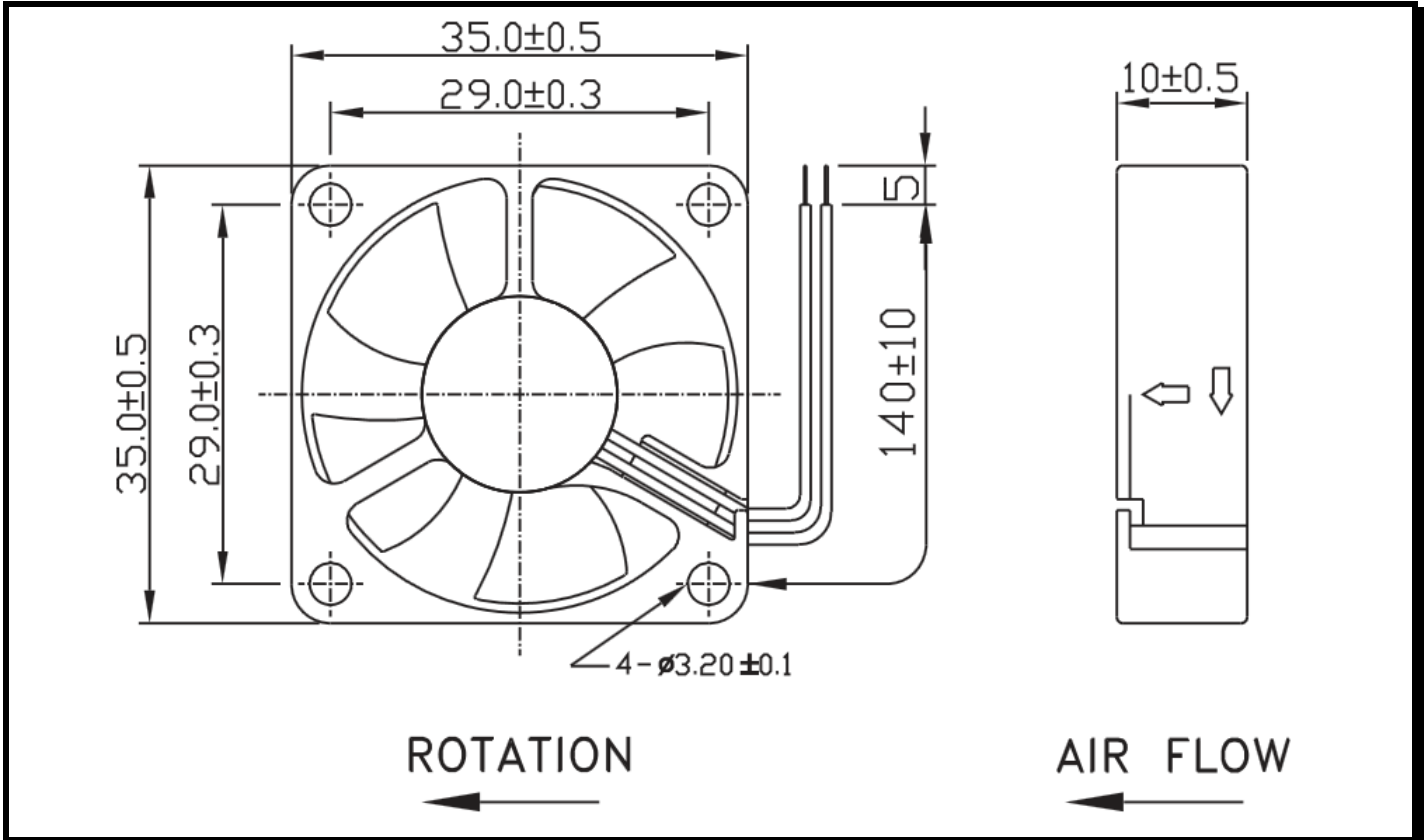

Motor:

Nominal Voltage	= 12 VDC
Nominal Running Current	= 0.06 Amps
Power Input	= 0.66 Watts
Speed	= 8000 RPM
Bearings	= Ball
Air Flow	= 6.0 CFM
Static Pressure:	= 0.17 Inch of H ₂ O
Acoustic	= 32.0 dB(A)
Weight	= 9.0 g

Construction:

Housing: UL94V-0 Glass Filled Polyester (P.B.T)
Impeller: UL94V-0 Glass Filled Polyester (P.B.T)

Life Expectancy:

This fan is designed for continuous duty life of 70,000 hours at 40°C.

Additional Features:

Brushless DC Motor
Locked Rotor Protection
Polarity Protected
Automatic Restart Capability
Operating Temperature: -10° C to 70° C
Storage Temperature: -40° C to 70° C

Termination:

140 ± 10 mm Lead wires, AWG 28, UL 1571

Agency Approvals:

UL, CUL, TUV, CE