

IPCV 16/ 6-G-10,16

Order No.: 1969739

The figure shows a 5-pos. version of the product

<http://eshop.phoenixcontact.de/phoenix/treeViewClick.do?UID=1969739>

Header, Nominal current: 76 A, Rated voltage (III/2): 1000 V, Number of positions: 6, Pitch: 10.16 mm, Color: green, Metal surface: Sn, Assembly: Soldering

Commercial data	
GTIN (EAN)	 4 017918 946753
sales group	E541
Pack	50 pcs.
Customs tariff	85366990
Catalog page information	Page 426 (CC-2009)

Product notesWEEE/RoHS-compliant since:
05/05/2003

<http://www.download.phoenixcontact.com>
Please note that the data given here has been taken from the online catalog. For comprehensive information and data, please refer to the user documentation. The General Terms and Conditions of Use apply to Internet downloads.

Technical data	
Dimensions / positions	
Length	13.6 mm
Pitch	10.16 mm
Dimension a	50.8 mm
Number of positions	6

Pin dimensions	0,8 x 1,2
Pin spacing	10.16 mm
Hole diameter	1.7 mm

Technical data

Range of articles	IPCV 16/..-G
Insulating material group	I
Rated surge voltage (III/3)	8 kV
Rated surge voltage (III/2)	8 kV
Rated surge voltage (II/2)	8 kV
Rated voltage (III/2)	1000 V
Rated voltage (II/2)	1000 V
Nominal current I_N	76 A
Nominal voltage U_N	1000 V
Maximum load current	76 A
Insulating material	PA
Inflammability class acc. to UL 94	V0
Nominal voltage, UL/CUL Use Group B	300 V
Nominal current, UL/CUL Use Group B	66 A
Nominal voltage, UL/CUL Use Group C	300 V
Nominal current, UL/CUL Use Group C	66 A
Nominal voltage, UL/CUL Use Group D	600 V
Nominal current, UL/CUL Use Group D	5 A

Certificates / Approvals



Certification

CB, CCA, CUL, SEV, UL

Accessories

Item	Designation	Description
General		
1970016	CS-IPC 16/ 6	Coding pin, serves to ensure correct polarization on the PCB during manual mounting
Marking		
0805179	SK 10/5:SO	Marker card, special printing, self-adhesive, labeled acc. to customer requirements, 10 identical marker strips per card, max. 25-position labeling per strip, color: White
0803922	SK U/5,0 WH:UNBEDRUCKT	Kennzeichnungskarten unbedruckt, DIN A4-Format, freie Rastereinteilung, selbstklebend, mit 35 vorgestanzten Kennzeichnungstreifen, 185 mm Streifenlänge, beschriftbar mit dem CMS-System oder manuell mit dem B-STIFT oder X-PEN
Plug/Adapter		
1600027	CP-HCC 4	Coding profile, Color: red

Diagrams/Drawings

Drilling plan/solder pad geometry

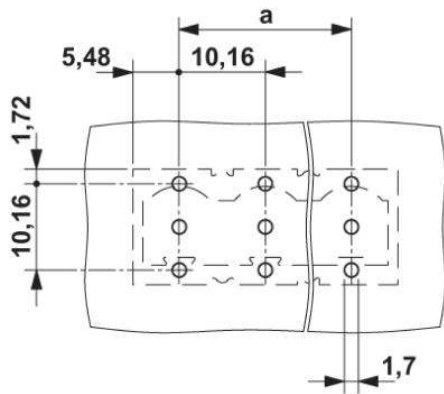

The illustration shows the 3-pos. version

Diagram

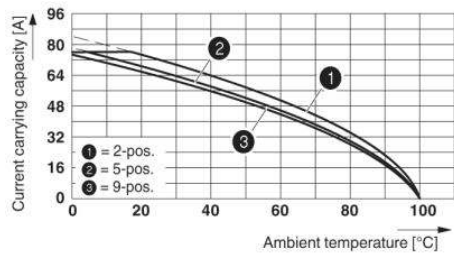

Derating curve for: ISPC 16/...-ST-10,16 with IPCV 16/...-G-10,16

Dimensioned drawing

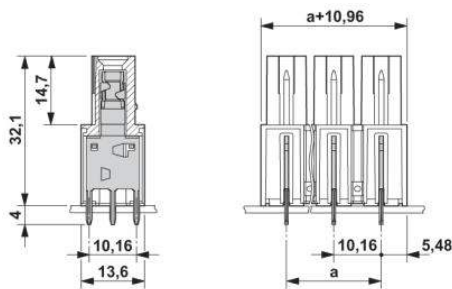

The illustration shows the 3-pos. version

Address

PHOENIX CONTACT Inc., USA
586 Fulling Mill Road
Middletown, PA 17057, USA
Phone (800) 888-7388
Fax (717) 944-1625
<http://www.phoenixcon.com>



© 2011 Phoenix Contact
Technical modifications reserved;