



EVBL9841-L-00A

36V, 1A, Low I_Q, Synchronous, Step-Down Switch-Mode Convertor Evaluation Board

DESCRIPTION

The EVBL9841-L-00A is an evaluation board designed to demonstrate the capabilities of the MP9841 and the MPQ9841. The evaluation board features an integrated MPS power inductor.

The MP9841 is a configurable-frequency (350kHz to 2.5MHz), synchronous, step-down switch-mode converter with integrated, internal power MOSFETs. It can achieve up to 1A of highly efficient output current (I_{OUT}) across a wide 3.3V to 36V input voltage (V_{IN}) range, with current mode control for fast loop response.

Advanced asynchronous modulation (AAM) mode achieves high efficiency under light-load conditions by scaling down the switching frequency (f_{sw}) to reduce the switching and gate driver losses.

The EV9841-L-00A is a fully assembled and tested evaluation board that generates 3.3V of output voltage (V_{OUT}) and up 1A of load current across the entire V_{IN} range.

ELECTRICAL SPECIFICATIONS

Parameter	Symbol	Value	Units
Input voltage	V _{IN}	3.3 to 36	V
Output voltage	V _{OUT}	3.3	V
Output current	I _{OUT}	1	A

FEATURES

- Wide 3.3V to 36V Operating Input Voltage (V_{IN}) Range
- Up to 1A Continuous Output Current (I_{OUT})
- 2μA Low Shutdown Current (I_{SD})
- 14μA Sleep Mode Quiescent Current (I_Q)
- 125mΩ and 115mΩ Internal Power MOSFETs
- Synchronous Mode for High Efficiency
- 350kHz to 2.5MHz Configurable Switching Frequency (f_{sw})
Selectable In-Phase or 180° Out-of-Phase External SYNC Clock
- Power Good (PG) Indication
- Configurable Soft-Start Time (t_{SS})
- 80ns Minimum On Time
- Selectable Forced Continuous Conduction Mode (FCCM) and Advanced Asynchronous Modulation (AAM) Mode
- Low-Dropout (LDO) Mode
- Over-Current Protection (OCP) with Valley-Current Detection and Hiccup Mode
- Thermal Shutdown
- Available in Wettable Flank Package
- Fully Assembled and Tested

 **Optimized Performance with MPS Inductor MPL-AL6060 Series**

APPLICATIONS

- Automotive Systems
- Industrial Power Systems

All MPS parts are lead-free, halogen-free, and adhere to the RoHS directive. For MPS green status, please visit the MPS website under Quality Assurance. "MPS", the MPS logo, and "Simple, Easy Solutions" are trademarks of Monolithic Power Systems, Inc. or its subsidiaries.

EVBL9841-L-00A EVALUATION BOARD



LxWxH (2.5cmx2.5cmx0.2cm)

Board Number	MPS IC Number	MPS Inductor
EVBL9841-L-00A	MP9841GL, MPQ9841GL	MPL-AL6060-100

Efficiency vs. Load Current vs. Power Loss

V_{OUT} = 3.3V, AAM mode

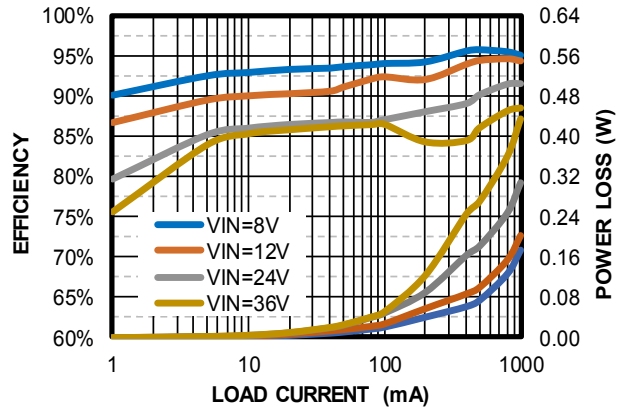

QUICK START GUIDE

1. Connect load terminals to:
 - a. Positive (+): VOUT
 - b. Negative (-): GND
2. Preset the power supply output to between 3.3V and 36V. Be aware that electronic loads represent a negative impedance to the converter, which can trigger hiccup mode if the current exceeds 2.5A.
3. Turn off the power supply. If longer cables (>0.5m total) are being used between the source and the evaluation board, install a damping capacitor at the input terminals. This is critical when V_{IN} exceeds 24V.
4. Connect power supply terminals to:
 - a. Positive (+): VIN
 - b. Negative (-): GND
5. Turn on the power supply. The evaluation board should start up automatically.
6. To use the enable (EN) function, apply a digital input to the EN pin. Drive EN above 1.05V to turn the converter on; drive EN below 0.93V to turn it off.
7. The switching frequency (f_{SW}) can be configured via an external resistor (R_{FREQ}). R_{FREQ} can be estimated with Equation (1):

$$R_{FREQ} (k\Omega) = \frac{170000}{f_{SW}^{1.11} (kHz)} \quad (1)$$

8. To use the synchronous (SYNC) function, apply a 350kHz to 2.5MHz clock to the SYNC pin to synchronize f_{SW} to the external clock. The external clock should be at least 250kHz above f_{SW}.
9. The SYNC pin also selects either forced continuous conduction mode (FCCM) or advanced asynchronous modulation (AAM) mode. Drive SYNC high to make the device operate in FCCM; drive SYNC low or float SYNC to have it operate in AAM mode.
10. The output voltage is set by the external resistor divider (R_{FB1} + R_{FB2}). Choose R_{FB1} to be about 40kΩ. Then R_{FB2} can be calculated with below Equation (2):

$$R_{FB2} = \frac{R_{FB1}}{\frac{V_{OUT}}{0.8V} - 1} \quad (2)$$

Figure 1 shows the feedback circuit.

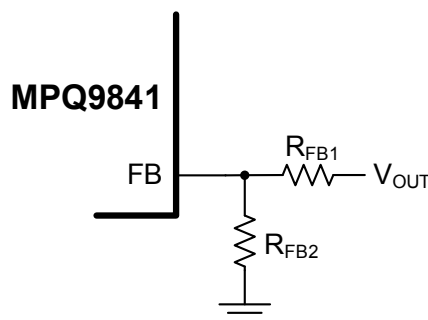

Figure 1: Feedback Circuit

Table 1 lists the recommended feedback resistor values for common output voltages.

Table 1: Recommended Resistor Values for Common Output Voltages

V_{OUT} (V)	R_{FB1} (kΩ)	R_{FB2} (kΩ)
1.8	41.2 (1%)	33 (1%)
2.5	41.2 (1%)	19.6 (1%)
3.3	41.2 (1%)	13 (1%)
5	41.2 (1%)	7.68 (1%)
12	41.2 (1%)	2.94 (1%)

EVALUATION BOARD SCHEMATIC

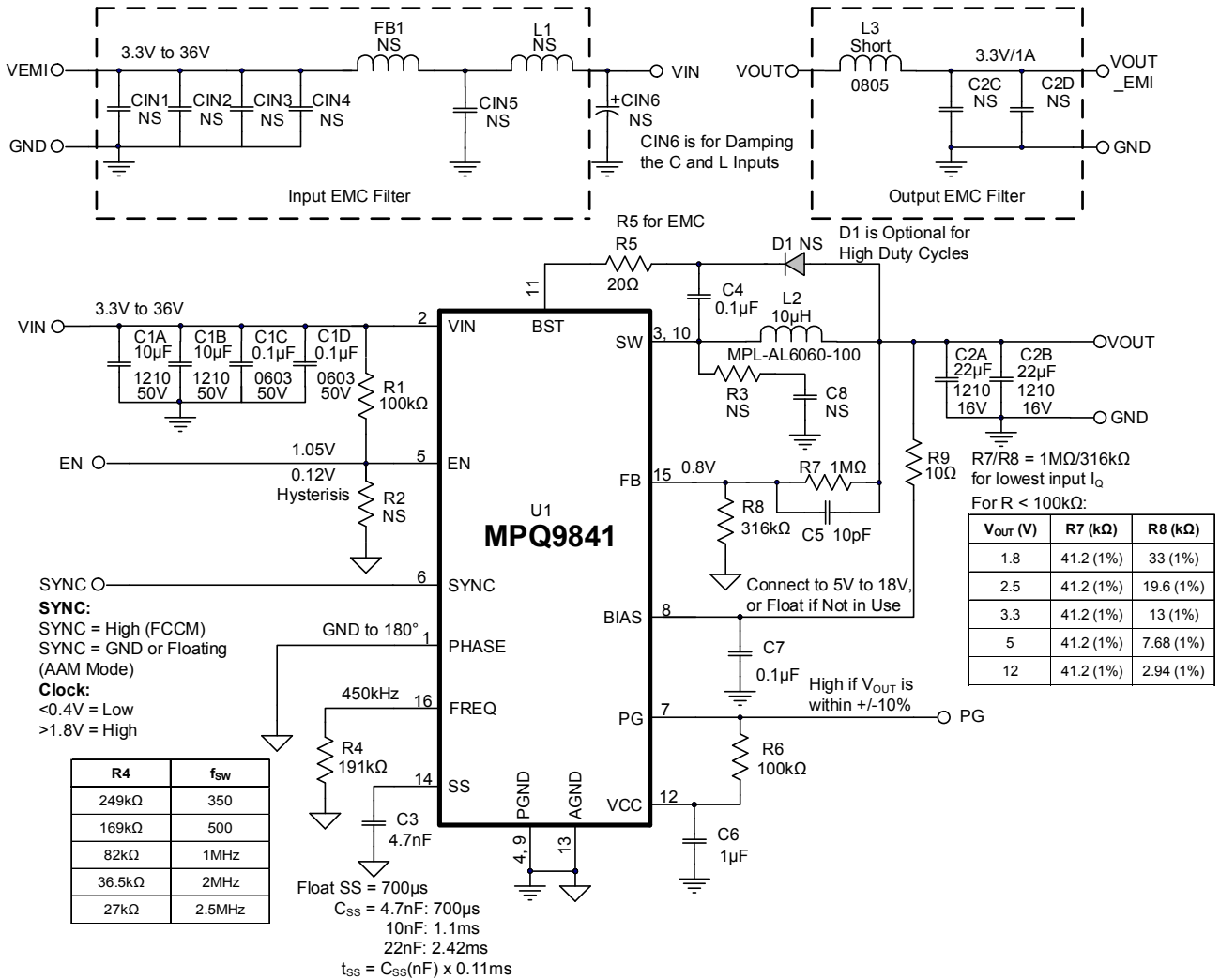
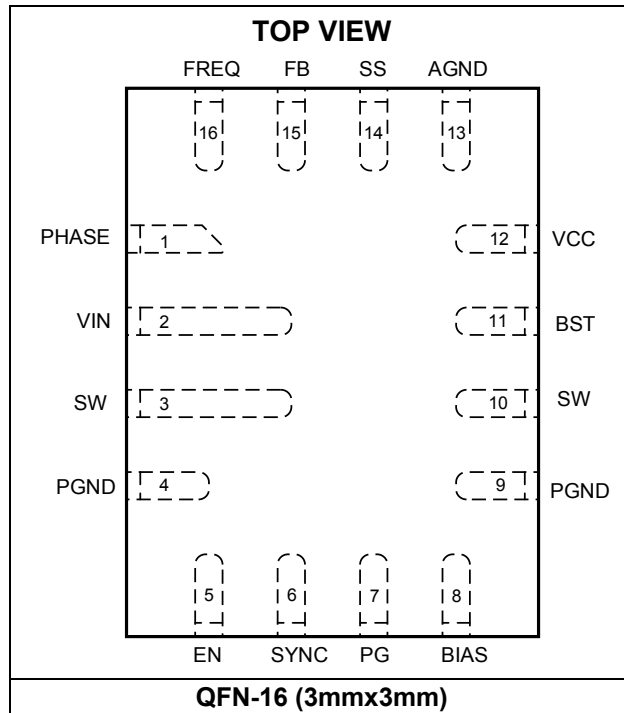

Figure 2: Evaluation Board Layout

PACKAGE REFERENCE



EVBL9841-L-00A BILL OF MATERIALS

Qty	Ref	Value	Description	Package	Manufacturer	Manufacturer PN
1	L2	MPL-AL6060-100	Inductor, 10 μ H, 27m Ω DCR, 7A	SMD	MPS	MPL-AL6060-100
2	C1A, C1B	10 μ F	Ceramic capacitor, 50V, X7R	1210	Murata	GRM32ER71H106KA12L
2	C1C, C1D	0.1 μ F	Ceramic capacitor, 50V, X7R	0603	Murata	GRM188R71H104KA93D
2	C2A, C2B	22 μ F	Ceramic capacitor, 25V, X7R	1210	Murata	GRM32ER71H226KE15L
1	C3	4.7nF	Ceramic capacitor, 50V, X7R	0603	TDK	C1608X7R1H472K
2	C4, C7	0.1 μ F	Ceramic capacitor, 16V, X7R	0603	Murata	GRM188R71C104KA01D
1	C5	10pF	Ceramic capacitor, 50V, C0G	0603	TDK	C1608C0G1H100D
1	C6	1 μ F	Ceramic capacitor, 16V, X7R	0603	TDK	C1608X7R1C105K
9	CIN1, CIN2, CIN3, CIN4, CIN5, CIN6, C2C, C2D, C8	NS				
1	D1	NS				
1	FB1	NS				
1	L1	NS				
1	L3	Short				
2	R1, R6	100k Ω	Film resolution, 5%	0603	Yageo	RC0603JR-07100KL
1	R4	191k Ω	Film resolution, 1%	0603	Yageo	RC0603FR-07191KL
1	R5	20 Ω	Film resolution, 1%	0603	Yageo	RC0603FR-0720RL
1	R7	1M Ω	Film resolution, 1%	0603	Yageo	RC0603FR-071ML
1	R8	316k Ω	Film resolution, 1%	0603	Yageo	RC0603FR-07316KL
1	R9	10 Ω	Film resolution, 5%	0603	Yageo	RC0603JR-0710RL
2	R2, R3	NS				
5	VIN, VEMI, GND, VOUT, GND	2mm	2mm golden pin, test point	DIP	Custom ⁽¹⁾	
5	EN, GND, SYNC, GND, PG	1mm	1mm golden pin, test point	DIP	Custom ⁽¹⁾	
1	U1	MP9841	Synchronous, step-down converter, 36V, 1A	QFN-16 (3mmx4mm)	MPS	MP9841GL

Note:

1) These pins are custom-made by MPS. For more information, contact an MPS FAE.

EVB TEST RESULTS

V_{IN} = 12V, V_{OUT} = 3.3V, L = 10μH, f_{SW} = 450KHz, T_A = 25°C, unless otherwise noted.

Efficiency vs. Load Current vs. Power Loss
V_{OUT} = 3.3V, AAM mode

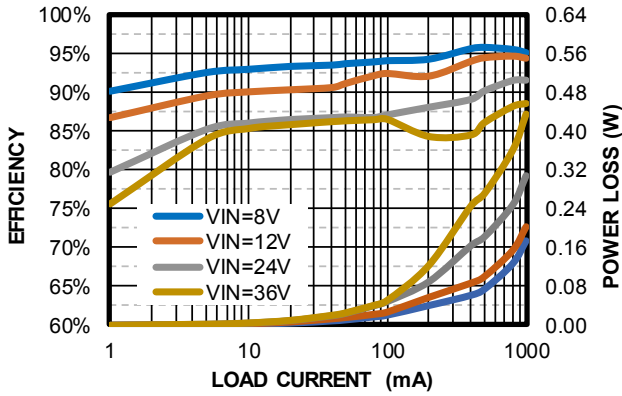

Efficiency vs. Load Current vs. Power Loss
V_{OUT} = 3.3V, FCCM

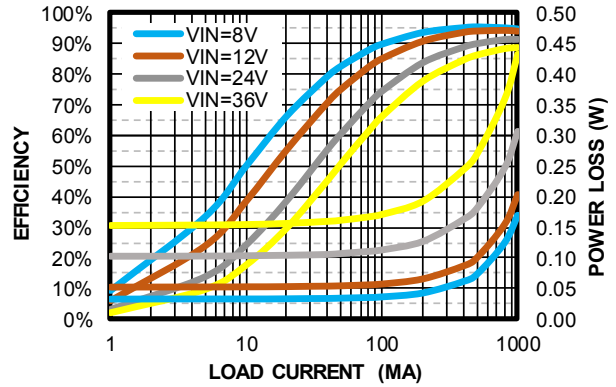

Efficiency vs. Load Current vs. Power Loss
V_{OUT} = 5V, AAM mode

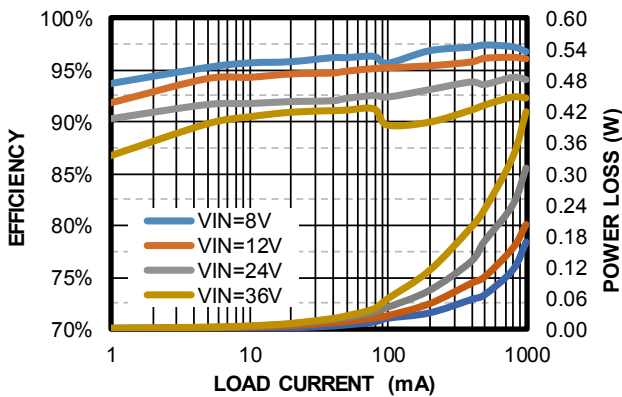

Efficiency vs. Load Current
V_{OUT} = 5V, FCCM

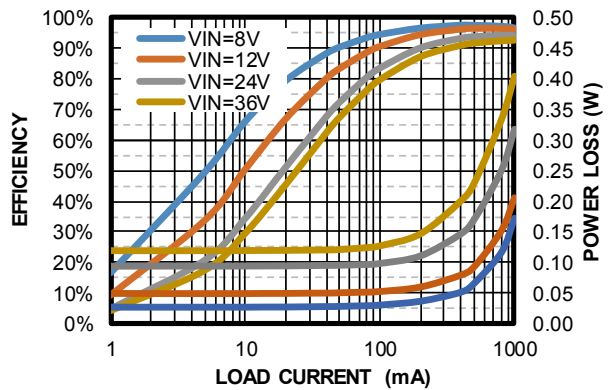

EVB TEST RESULTS (continued)

V_{IN} = 12V, V_{OUT} = 3.3V, L = 10μH, f_{sw} = 450KHz, T_A = 25°C, unless otherwise noted.

Steady State

V_{IN} = 12V, V_{OUT} = 3.3V, I_{OUT} = 0A, AAM mode

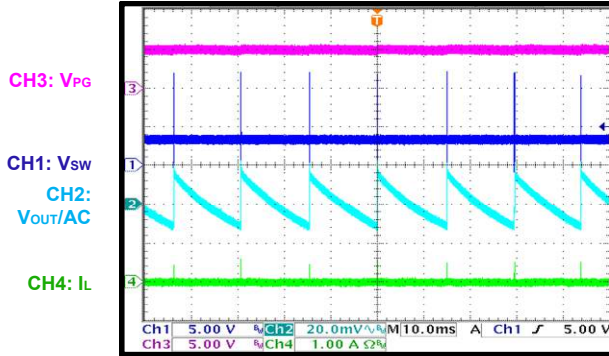

Steady State

V_{IN} = 12V, V_{OUT} = 3.3V, I_{OUT} = 0A, FCCM

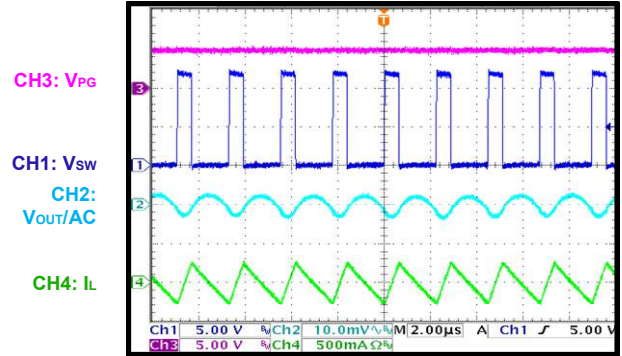

Steady State

V_{IN} = 12V, V_{OUT} = 3.3V, I_{OUT} = 1A

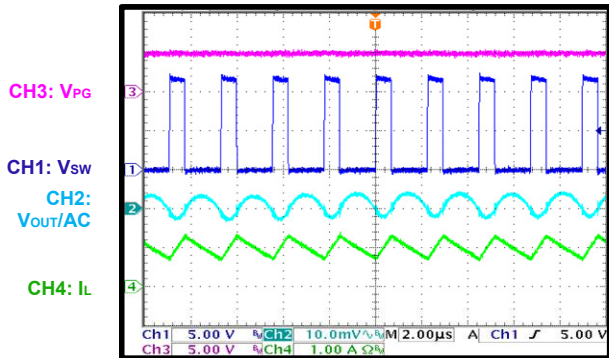

Start-Up

V_{IN} = 12V, V_{OUT} = 3.3V, I_{OUT} = 0A, AAM mode

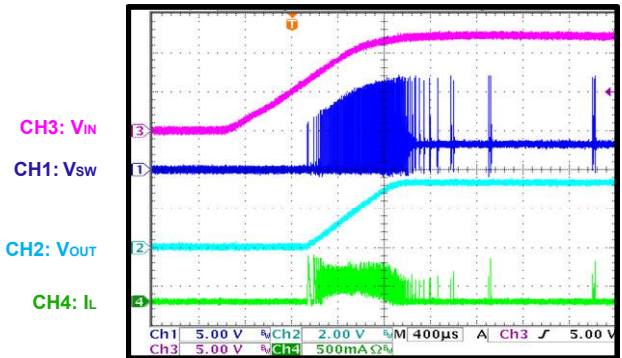

Start-Up

V_{IN} = 12V, V_{OUT} = 3.3V, I_{OUT} = 0A, FCCM

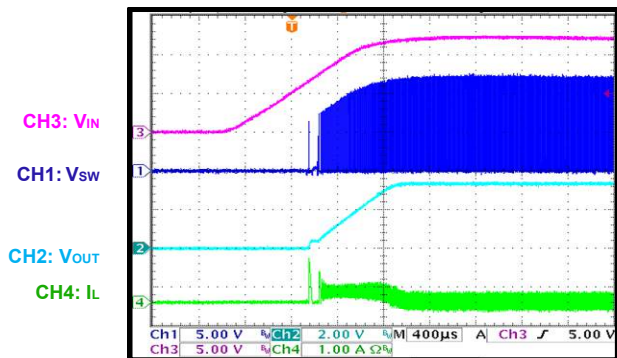

Start-Up

V_{IN} = 12V, V_{OUT} = 3.3V, I_{OUT} = 1A

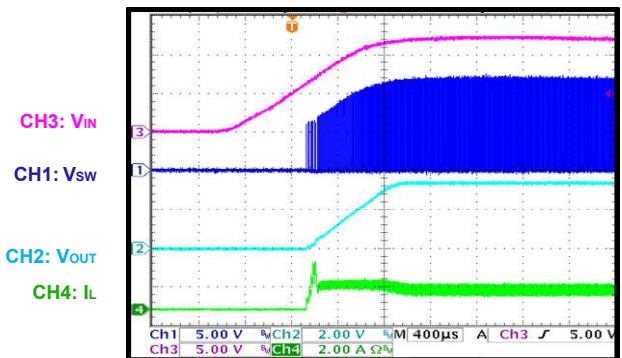

EVB TEST RESULTS (continued)

V_{IN} = 12V, V_{OUT} = 3.3V, L = 10μH, f_{sw} = 450KHz, T_A = 25°C, unless otherwise noted.

Shutdown

V_{IN} = 12V, V_{OUT} = 3.3V, I_{OUT} = 0A, AAM mode

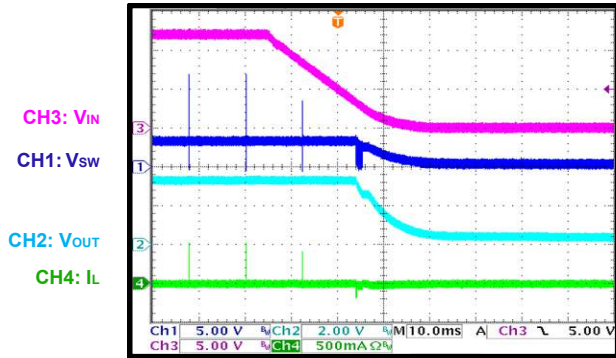

Shutdown

V_{IN} = 12V, V_{OUT} = 3.3V, I_{OUT} = 0A, FCCM

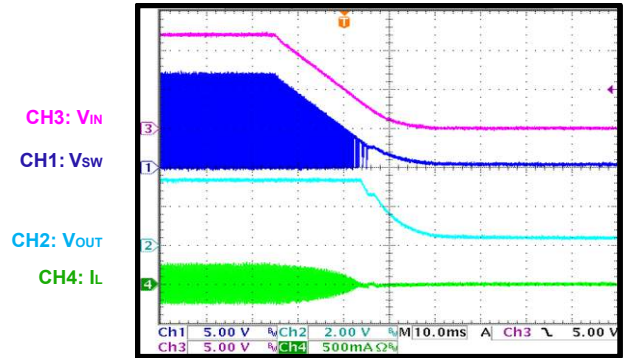

Shutdown

V_{IN} = 12V, V_{OUT} = 3.3V, I_{OUT} = 1A

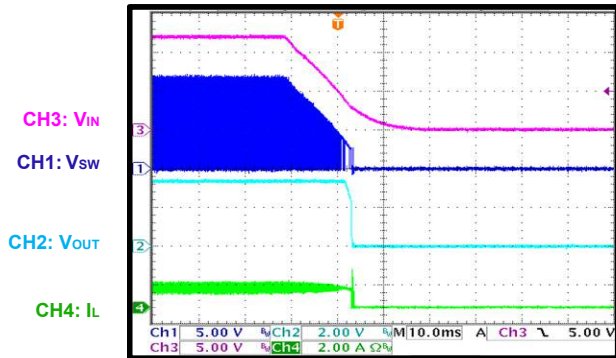

Start-Up through EN

V_{IN} = 12V, V_{OUT} = 3.3V, I_{OUT} = 0A, AAM mode

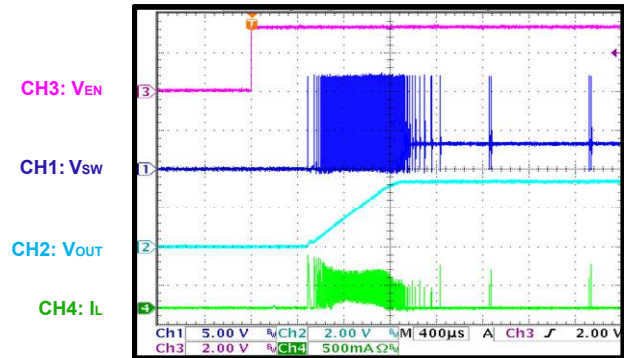

Start-Up through EN

V_{IN} = 12V, V_{OUT} = 3.3V, I_{OUT} = 0A, FCCM

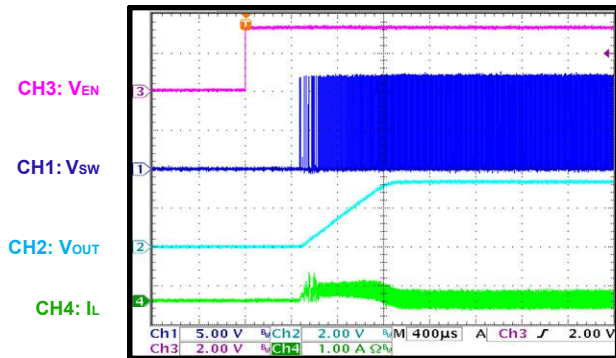

Start-Up through EN

V_{IN} = 12V, V_{OUT} = 3.3V, I_{OUT} = 1A

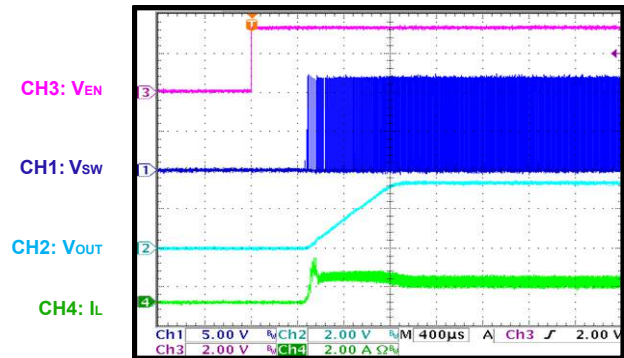

EVB TEST RESULTS (continued)

V_{IN} = 12V, V_{OUT} = 3.3V, L = 10µH, f_{sw} = 450KHz, T_A = 25°C, unless otherwise noted.

Shutdown through EN

V_{IN} = 12V, V_{OUT} = 3.3V, I_{OUT} = 0A, AAM mode

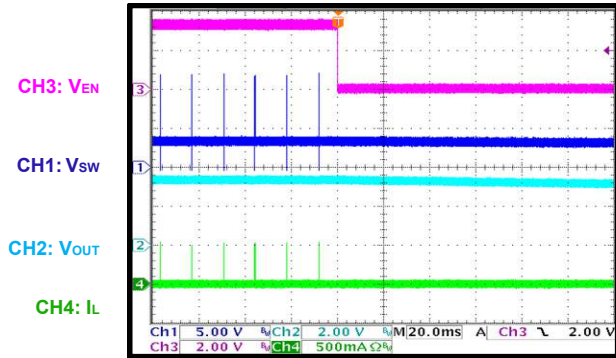

Shutdown through EN

V_{IN} = 12V, V_{OUT} = 3.3V, I_{OUT} = 0A, FCCM

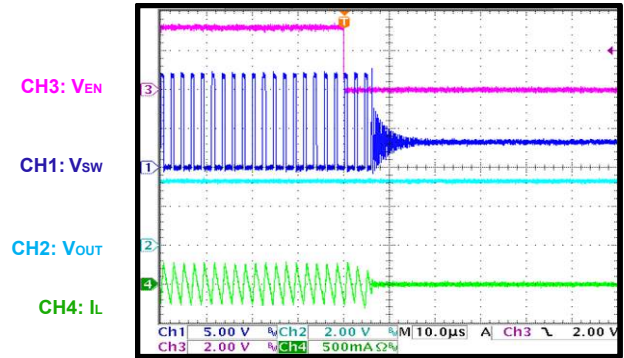

Shutdown through EN

V_{IN} = 12V, V_{OUT} = 3.3V, I_{OUT} = 1A

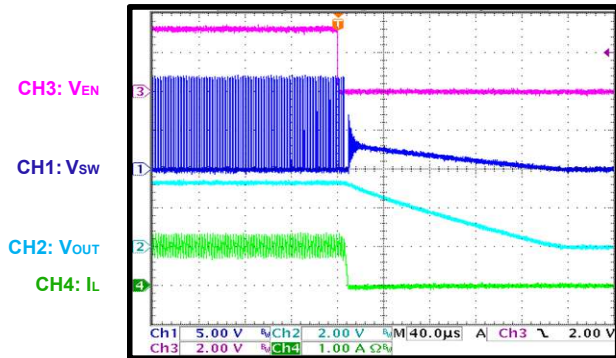

SCP Entry

V_{IN} = 12V, V_{OUT} = 3.3V, I_{OUT} = 0A, AAM mode

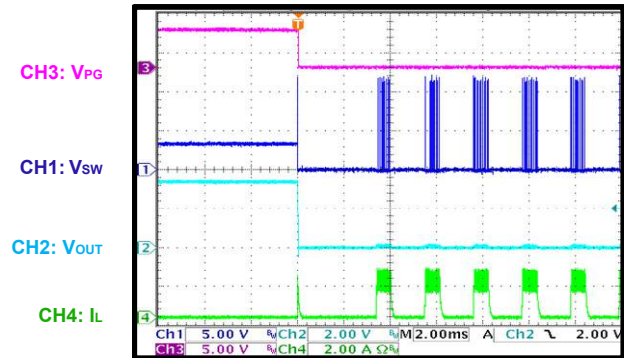

SCP Entry

V_{IN} = 12V, V_{OUT} = 3.3V, I_{OUT} = 0A, FCCM

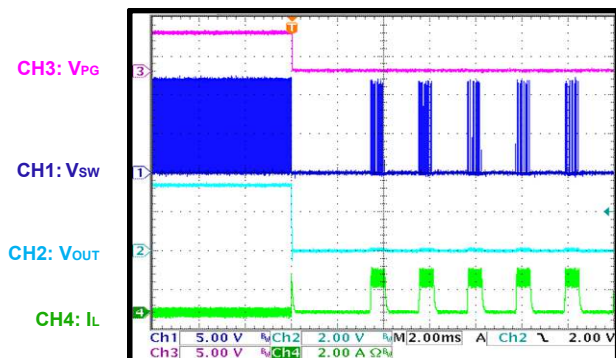

SCP Entry

V_{IN} = 12V, V_{OUT} = 3.3V, I_{OUT} = 1A

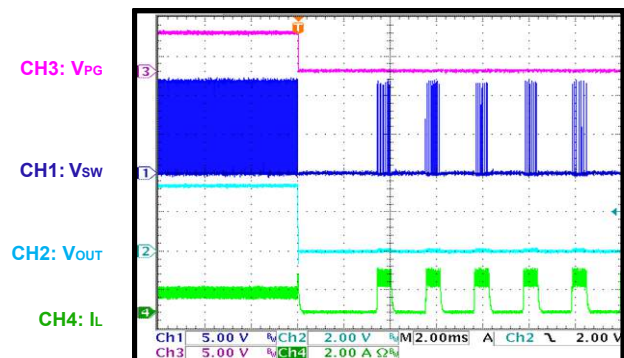

EVB TEST RESULTS (continued)

V_{IN} = 12V, V_{OUT} = 3.3V, L = 10µH, f_{sw} = 450KHz, T_A = 25°C, unless otherwise noted.

SCP Steady State

V_{IN} = 12V

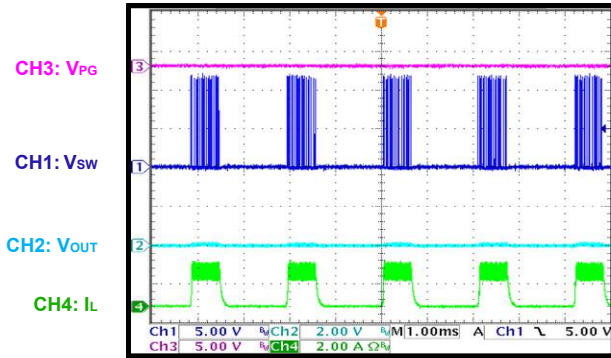

SCP Recovery

V_{IN} = 12V, V_{OUT} = 3.3V, I_{OUT} = 0A, AAM mode

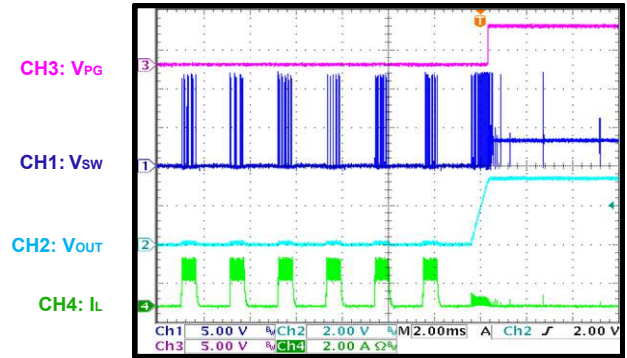

SCP Recovery

V_{IN} = 12V, V_{OUT} = 3.3V, I_{OUT} = 0A, FCCM

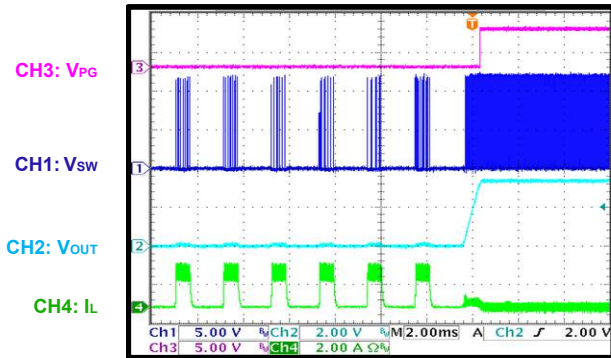

SCP Recovery

V_{IN} = 12V, V_{OUT} = 3.3V, I_{OUT} = 1A

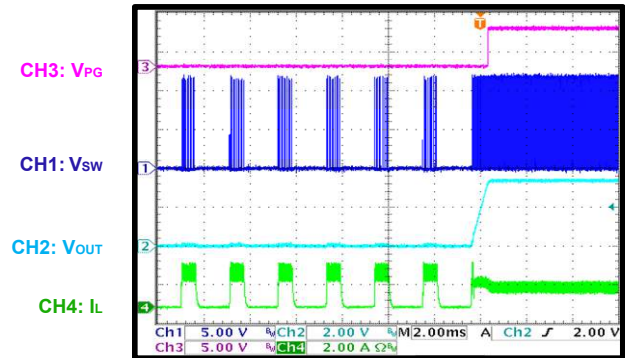

Load Transient

V_{IN} = 12V, V_{OUT} = 3.3V, I_{OUT} = 0.5A to 1A

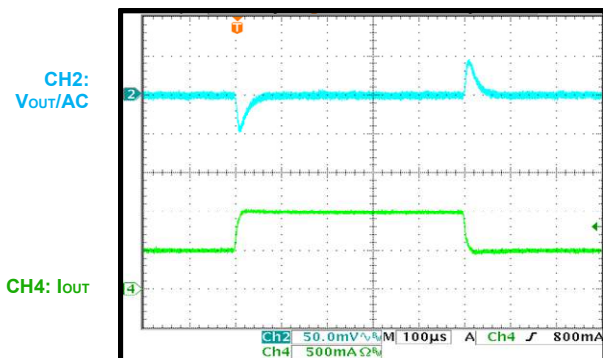

Cold Crank

V_{IN} = 12V to 3.3V to 5V, I_{OUT} = 0A, AAM mode

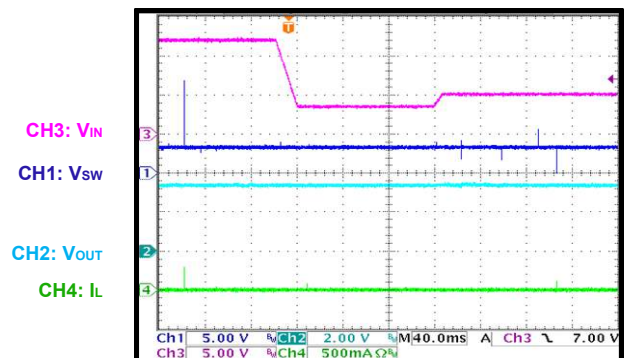

EVB TEST RESULTS (continued)

V_{IN} = 12V, V_{OUT} = 3.3V, L = 10μH, f_{sw} = 450KHz, T_A = 25°C, unless otherwise noted.

Cold Crank

V_{IN} = 12V to 3.3V to 5V, I_{OUT} = 1A

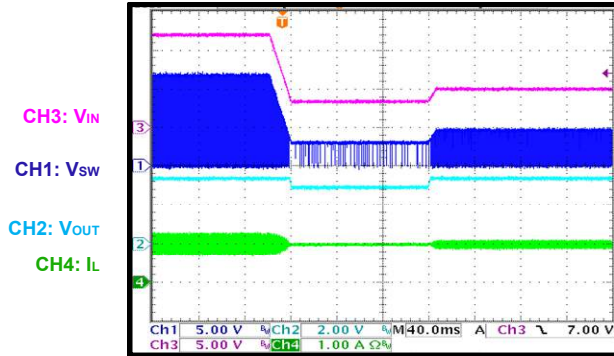

V_{IN} Ramps Down and Up

V_{IN} = 18V to 3.3V to 0V to 3.3V to 18V, I_{OUT} = 0A, AAM mode

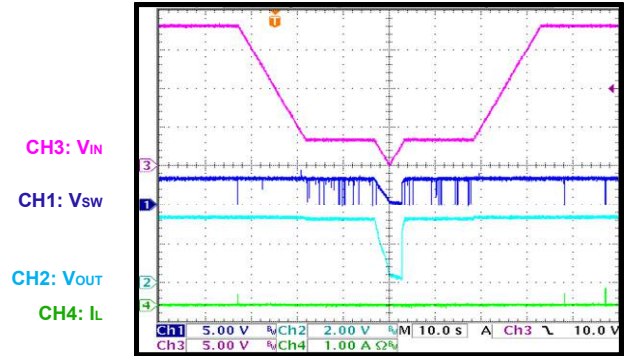

V_{IN} Ramps Down and Up

V_{IN} = 18V to 3.3V to 0V to 3.3V to 18V, I_{OUT} = 1A

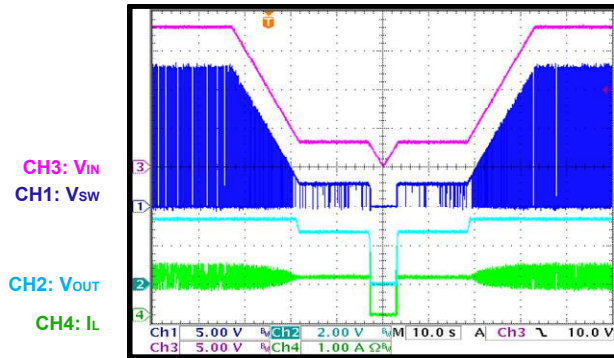

Load Dump

V_{IN} = 12V to 36V to 12V, I_{OUT} = 1A

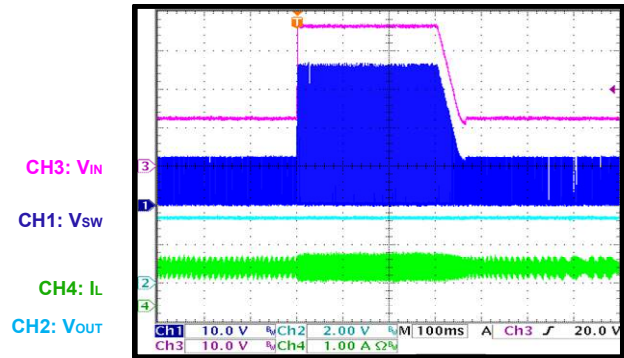

PCB LAYOUT

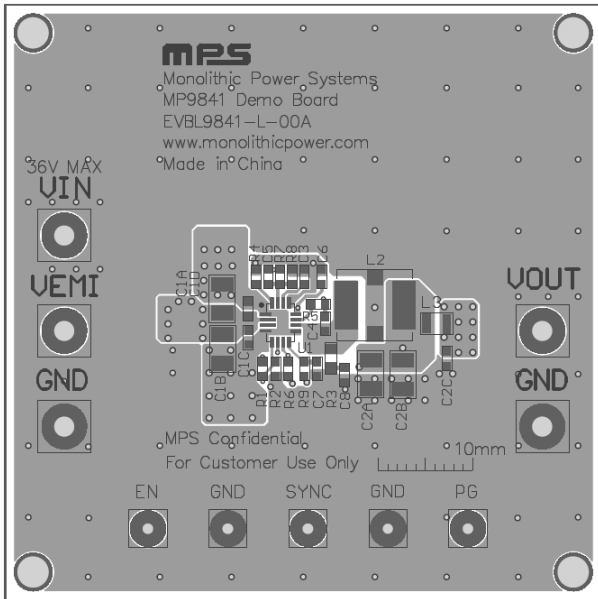

Figure 3: Top Silk and Top Layer

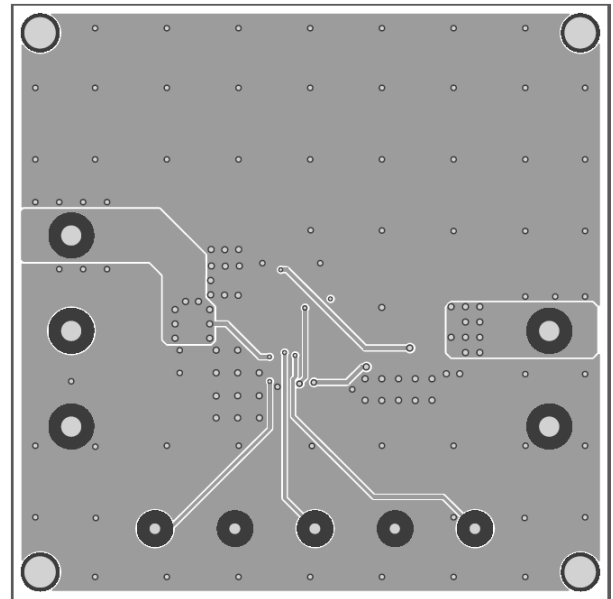

Figure 4: Mid-Layer 1

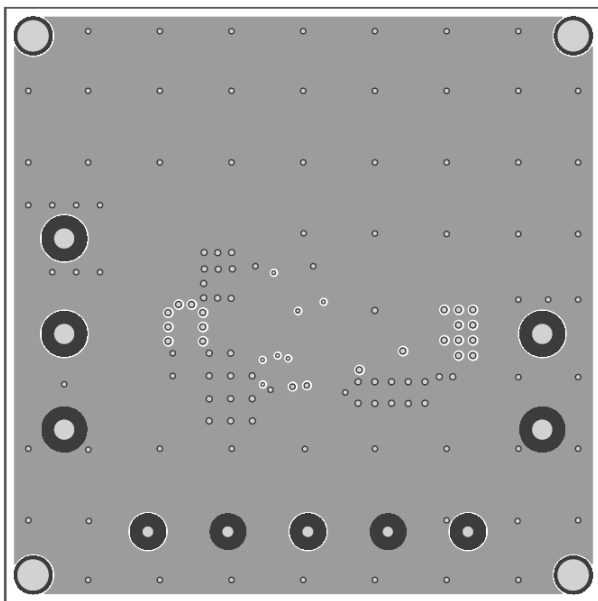

Figure 5: Mid-Layer 2

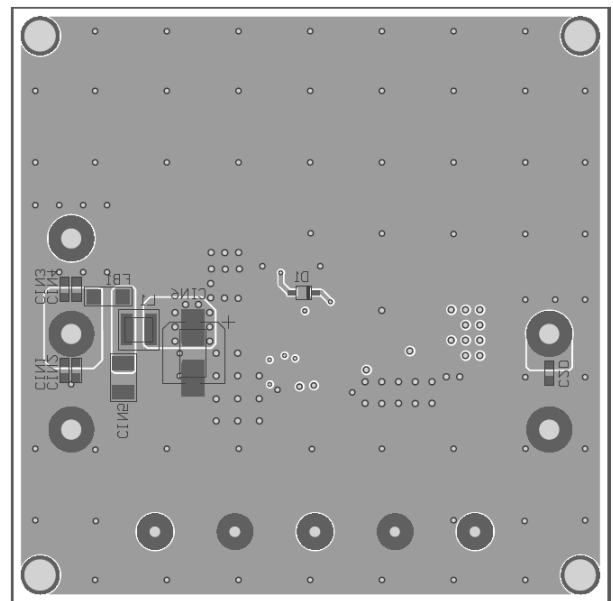

Figure 6: Bottom Layer and Bottom Silk

REVISION HISTORY

Revision #	Revision Date	Description	Pages Updated
1.0	10/12/2019	Initial Release	-
1.1	9/14/2020	Updated the Quick Start Guide section	3–4
		Updated the soft-start time (t_{ss}) formula in Figure 2 from “ $T_{ss}=C_{ss}(nF)*0.08ms$ ” to “ $T_{ss} = C_{ss}(nF) \times 0.11ms$ ”	5
		Updated the EVBL9841-L-00A Bill of Materials section	7
		Grammar and formatting updates; updated headers and footers; updated figure titles; updated pagination	All

Notice: The information in this document is subject to change without notice. Please contact MPS for current specifications. Users should warrant and guarantee that third-party Intellectual Property rights are not infringed upon when integrating MPS products into any application. MPS will not assume any legal responsibility for any said applications.