

NO. OF CKTS.	DIM. A	DIM. B	SLOT LOC BETWEEN CKTS
2	7.77 .306	3.96±0.05 .156±.002	NONE
3	11.73 .462	7.92±0.08 .312±.003	NONE
4	15.70 .618	11.89±0.08 .468±.003	NONE
5	19.66 .774	15.85±0.10 .624±.004	NONE
6	23.62 .930	19.81±0.10 .780±.004	3 & 4
7	27.58 1.086	23.77±0.10 .936±.004	4 & 5
8	31.55 1.242	27.74±0.13 1.092±.005	4 & 5
9	35.51 1.398	31.70±0.13 1.248±.005	5 & 6
10	39.47 1.554	35.66±0.13 1.404±.005	5 & 6
11	43.43 1.710	39.62±0.15 1.560±.006	6 & 7
12	47.40 1.866	43.59±0.15 1.716±.006	4 & 5 8 & 9

THIS DRAWING CONTAINS INFORMATION THAT IS PROPRIETARY TO MOLEX ELECTRONIC TECHNOLOGIES, LLC AND SHOULD NOT BE USED WITHOUT WRITTEN PERMISSION

DIMENSION UNITS	SCALE	CURRENT REV DESC: REMASTERED IN NX	
mm	2:1		
GENERAL TOLERANCES (UNLESS SPECIFIED)			
	MM	INCH	
4 PLACES	±	±	EC NO: 613774
3 PLACES	±	± 0.01	DRWN: SS06 2019/03/08
2 PLACES	± 0.25	± 0.015	CHK'D: ISHWARG 2019/03/15
1 PLACE	± 0.38	±	APPR: ISHWARG 2019/03/15
0 PLACES	±	±	INITIAL REVISION:
ANGULAR TOL ± 0.5 °		DRWN: JSCHAFFER 11-25-03	
DRAFT WHERE APPLICABLE MUST REMAIN WITHIN DIMENSIONS		APPR: MARGULIS 12-1-03	

molex

KK .156 HEADER ASSEMBLY
FRICTION LOCK RT ANGLE WITH PEGS

PRODUCT CUSTOMER DRAWING

DOCUMENT NUMBER	DOC TYPE	DOC PART	REVISION
SD-42492-001	PSD	001	G2

DOCUMENT STATUS	P1	RELEASE DATE	2019/03/15	05:07:15
-----------------	----	--------------	------------	----------

THIRD ANGLE PROJECTION	DRAWING	SERIES	MATERIAL NUMBER	CUSTOMER	SHEET NUMBER
	A-SIZE	42492	SEE CHART	GENERAL MARKET	1 OF 7

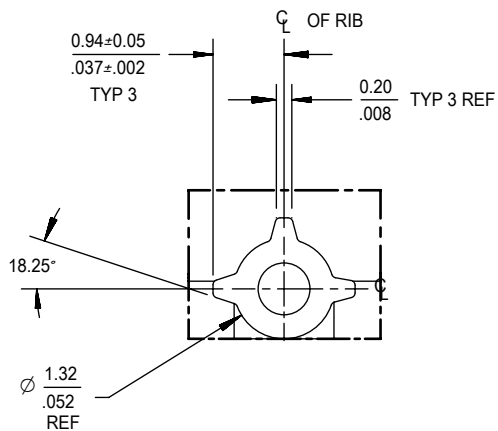

PEG DETAIL
SCALE 10:1

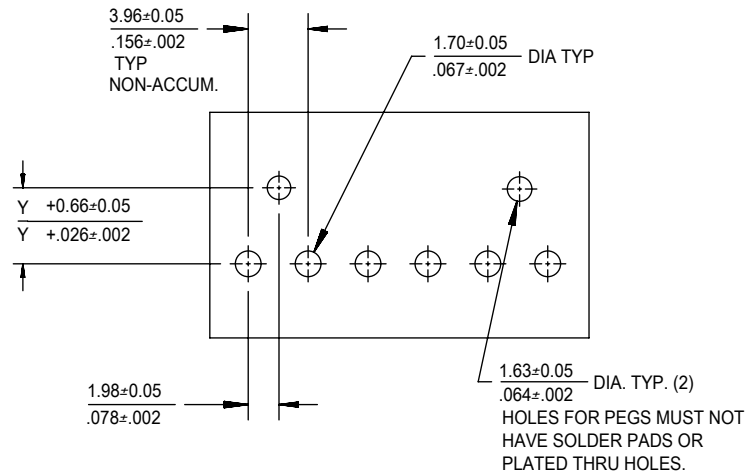

RECOMMENDED PC BOARD HOLE LAYOUT

NOTES:

1. MATERIAL: HEADER-POLYESTER, 94V-0, MOLDED NATURAL (WHITE)
PINS: BRASS
2. FINISHES: (154) OVERALL TIN 0.00254/.000100 MIN.
OVER 0.00127/.000050 MIN. NICKEL.
(197) OVERALL REFLOWED MATTE TIN: 0.00152/.000060 MIN.
OVER 0.00127/.000050 MIN. NICKEL OVERALL.
(208) SELECT GOLD 0.00038/.000015 MIN.
SELECT TIN 0.00254/.000100 MIN.
OVERALL NICKEL UNDERPLATE 0.00127/.000050 MIN.
(228) SELECT GOLD 0.00076/.000030 MIN.
SELECT TIN 0.00254/.000100 MIN.
OVERALL NICKEL UNDERPLATE 0.00127/.000050 MIN.
(241) SELECT GOLD: 0.00051/.000020 MIN.
SELECT TIN: 0.00254/.000100 MIN.
OVERALL NICKEL UNDERPLATE: 0.00127/.000050 MIN.
3. PRODUCT SPECIFICATION: SEE PS-08-50.
4. PACKAGING INFO: SEE TABLES.
5. SOLDERABILITY: PER SMES-152.
6. PIN PUSH OUT FORCE: PRIOR TO SOLDERING, A 3 LB MINIMUM FORCE (IN EITHER DIRECTION) SHALL BE REQUIRED TO PUSH THE PIN OUT OF THE HEADER.
7. PARTS ARE STACKABLE END TO END ON 3.96/.156 CENTERS.
8. FOR PART WITHOUT PEGS SEE 41792.
9. THIS PART CONFORMS TO CLASS B REQUIREMENTS OF COSMETIC SPECIFICATION PS-45499-002.
10. SLOTS ON BACKWALL ARE BETWEEN CIRCUITS. SEE CHART FOR LOCATION.

THIS DRAWING CONTAINS INFORMATION THAT IS PROPRIETARY TO MOLEX ELECTRONIC TECHNOLOGIES, LLC AND SHOULD NOT BE USED WITHOUT WRITTEN PERMISSION

DIMENSION UNITS		SCALE		CURRENT REV DESC: REMASTERED IN NX						
mm		1:1								
GENERAL TOLERANCES (UNLESS SPECIFIED)				EC NO: 613774		KK .156 HEADER ASSEMBLY FRICTION LOCK RT ANGLE WITH PEGS				
				DRWN: SS06 2019/03/08						
				CHK'D: ISHWARG 2019/03/15						
				APPR: ISHWARG 2019/03/15		PRODUCT CUSTOMER DRAWING				
				INITIAL REVISION:		DOCUMENT NUMBER		DOC TYPE	DOC PART	REVISION
				DRWN: JSCHAFFER 11-25-03		SD-42492-001		PSD	001	G2
				APPR: MARGULIS 12-1-03						
DRAFT WHERE APPLICABLE MUST REMAIN WITHIN DIMENSIONS				THIRD ANGLE PROJECTION		DRAWING	SERIES	MATERIAL NUMBER	CUSTOMER	SHEET NUMBER
						A-SIZE	42492	SEE CHART	GENERAL MARKET	2 OF 7

DOCUMENT STATUS	P1	RELEASE DATE	2019/03/15	05:07:15
-----------------	----	--------------	------------	----------

OPTIONS	Group	A-42492-0002/0018	Group	A-42492-0319/0335	Group	A-42492-0336/0352	Group	
	Header No:	41790-0036/0052	Header No:	41790-0036/0052	Header No:	41790-0036/0052	Header No:	
	Pin No:	43294-0572	Pin No:	43294-0569	Pin No:	43294-0570	Pin No:	
	Plating:	197 - TIN	Plating:	208 - 15 GOLD	Plating:	228 - 30 GOLD	Plating:	
	Pin Length L	27.94/1.100	Pin Length L	27.94/1.100	Pin Length L	27.94/1.100	Pin Length L	
	Mating M	11.43 / .450	Mating M	11.43/.450	Mating M	11.43/.450	Mating M	
	Gold Loc G	N/A	Gold Loc G	6.86/. 270	Gold Loc G	6.86/. 270	Gold Loc G	
	Dim. Y	5.41/ .213	Dim. Y	5.41/ .213	Dim. Y	5.41/ .213	Dim. Y	
	PC Tail P	3.96 / .156	PC Tail P	3.96/ .156	PC Tail P	3.96/.156	PC Tail P	
	Tin Loc T	OVERALL	Tin Loc T	5.08 / .200	Tin Loc T	5.08 / .200	Tin Loc T	
	Voided Ckts	NONE	Voided Ckts	NONE	Voided Ckts	NONE	Voided Ckts	
	Pack Per	PK-42492-002	Pack Per	PK-42492-002	Pack Per	PK-42492-002	Pack Per	
Ckts	Material No	Engineer Number	Material No	Engineer Number	Material No	Engineer Number	Material No	Engineer Number
2	26-64-5020	A-42492-0002	42492-0319	A-42492-0319	42492-0336	A-42492-0336		
3	26-64-5030	A-42492-0003	42492-0320	A-42492-0320	42492-0337	A-42492-0337		
4	26-64-5040	A-42492-0004	42492-0321	A-42492-0321	42492-0338	A-42492-0338		
5	26-64-5050	A-42492-0005	42492-0322	A-42492-0322	42492-0339	A-42492-0339		
6	26-64-5060	A-42492-0006	42492-0323	A-42492-0323	42492-0340	A-42492-0340		
7	26-64-5070	A-42492-0007	42492-0324	A-42492-0324	42492-0341	A-42492-0341		
8	26-64-5080	A-42492-0008	42492-0325	A-42492-0325	42492-0342	A-42492-0342		
9	26-64-5090	A-42492-0009	42492-0326	A-42492-0326	42492-0343	A-42492-0343		
10	26-64-5100	A-42492-0010	42492-0327	A-42492-0327	42492-0344	A-42492-0344		
11	26-64-5110	A-42492-0011	42492-0328	A-42492-0328	42492-0345	A-42492-0345		
12	26-64-5120	A-42492-0012	42492-0329	A-42492-0329	42492-0346	A-42492-0346		
13								
14								
15								
16								
17								
18								

THIS DRAWING CONTAINS INFORMATION THAT IS PROPRIETARY TO MOLEX ELECTRONIC TECHNOLOGIES, LLC AND SHOULD NOT BE USED WITHOUT WRITTEN PERMISSION

DIMENSION UNITS mm	SCALE 2:1	CURRENT REV DESC: REMASTERED IN NX		<h1>molex</h1>
GENERAL TOLERANCES (UNLESS SPECIFIED)		EC NO: 613774		
4 PLACES ±	MM INCH	DRWN: SS06	2019/03/08	
3 PLACES ±	± 0.01	CHK'D: ISHWARG	2019/03/15	
2 PLACES ±	0.25 ± 0.015	APPR: ISHWARG	2019/03/15	PRODUCT CUSTOMER DRAWING
1 PLACE ±	0.38 ±	INITIAL REVISION:		
0 PLACES ±	±	DRWN: JSCHAFFER	11-25-03	DOCUMENT NUMBER SD-42492-001
ANGULAR TOL ±	0.5 °	APPR: MARGULIS	12-1-03	DOC TYPE PSD
DRAFT WHERE APPLICABLE MUST REMAIN WITHIN DIMENSIONS	THIRD ANGLE PROJECTION	DRAWING 	SERIES A-SIZE 42492	DOC PART 001
			MATERIAL NUMBER SEE CHART	REVISION G2
			CUSTOMER GENERAL MARKET	SHEET NUMBER 3 OF 7

DOCUMENT STATUS	P1	RELEASE DATE	2019/03/15	05:07:15
-----------------	----	--------------	------------	----------

D	OPTIONS	Group	A-42492-0036/0050	Group	A-42492-0244/0256	Group	A-42492-0258/0273	Group	A-42492-0274/0288
		Header No:	41790-0038/0052	Header No:	41790-0040/0052	Header No:	41790-0037/0052	Header No:	41790-0038/0052
		Pin No:	43294-0572	Pin No:	43294-0572	Pin No:	43294-0572	Pin No:	43294-0573
		Plating:	197 - TIN	Plating:	197 - TIN	Plating:	197 - TIN	Plating:	241 - GOLD
		Pin Length L	27.94/1.100	Pin Length L	27.94/1.100	Pin Length L	27.94/1.100	Pin Length L	27.94/1.100
		Mating M	11.43 / .450	Mating M	11.43/.450	Mating M	11.43/.450	Mating M	11.43/.450
		Gold Loc G	N/A	Gold Loc G	N/A	Gold Loc G	N/A	Gold Loc G	6.85/ .270
		Dim. Y	5.41/ .213	Dim. Y	5.41/ .213	Dim. Y	5.41/ .213	Dim. Y	5.41/ .213
		PC Tail P	3.96 / .156	PC Tail P	3.96/ .156	PC Tail P	3.96/.156	PC Tail P	3.96/.156
		Tin Loc T	OVERALL	Tin Loc T	OVERALL	Tin Loc T	OVERALL	Tin Loc T	5.08/ .200
		Voided Ckts	4	Voided Ckts	6	Voided CKts	2	Voided Ckts	4
		Pack Per	PK-42492-002	Pack Per	PK-42492-002	Pack Per	PK-42492-002	Pack Per	PK-42492-002
C	Ckts	Material No	Engineer Number	Material No	Engineer Number	Material No	Engineer Number	Material No	Engineer Number
	2								
	3								
	4	26-64-5042	A-42492-0036			26-66-0031	A-42492-0258		
	5	26-64-5052	A-42492-0037			26-66-0041	A-42492-0259	42492-0274	A-42492-0274
	6	26-64-5062	A-42492-0038	26-64-5061	A-42492-0244	26-66-0051	A-42492-0260	42492-0275	A-42492-0275
	7	26-64-5072	A-42492-0039	26-64-5071	A-42492-0245	26-66-0061	A-42492-0261	42492-0276	A-42492-0276
	8	26-64-5082	A-42492-0040	26-64-5081	A-42492-0246	26-66-0071	A-42492-0262	42492-0277	A-42492-0277
	9	26-64-5092	A-42492-0041	26-64-5091	A-42492-0247	26-66-0081	A-42492-0263	42492-0278	A-42492-0278
	10	26-64-5102	A-42492-0042	26-64-5101	A-42492-0248	26-66-0091	A-42492-0264	42492-0279	A-42492-0279
	11	26-64-5112	A-42492-0043	26-64-5111	A-42492-0249	26-66-0101	A-42492-0265	42492-0280	A-42492-0280
	12	26-64-5122	A-42492-0044	26-64-5121	A-42492-0250	26-66-0111	A-42492-0266	42492-0281	A-42492-0281
	13					26-66-0121	A-42492-0267	42492-0282	A-42492-0282
	14								
	15								
	16								
	17								
	18								

THIS DRAWING CONTAINS INFORMATION THAT IS PROPRIETARY TO MOLEX ELECTRONIC TECHNOLOGIES, LLC AND SHOULD NOT BE USED WITHOUT WRITTEN PERMISSION

DIMENSION UNITS	SCALE	CURRENT REV DESC: REMASTERED IN NX				
mm	2:1					
GENERAL TOLERANCES (UNLESS SPECIFIED)				EC NO: 613774 DRWN: SS06 2019/03/08 CHK'D: ISHWARG 2019/03/15 APPR: ISHWARG 2019/03/15		
	MM	INCH		PRODUCT CUSTOMER DRAWING		
4 PLACES	±	±		DOCUMENT NUMBER: SD-42492-001 DOC TYPE: PSD DOC PART: 001 REVISION: G2		
3 PLACES	±	± 0.01		INITIAL REVISION: DRWN: JSCHAFFER 11-25-03 APPR: MARGULIS 12-1-03		
2 PLACES	±	± 0.015		DRAFT WHERE APPLICABLE MUST REMAIN WITHIN DIMENSIONS		
1 PLACE	±	±		THIRD ANGLE PROJECTION		
0 PLACES	±	±		DRAWING: A-SIZE SERIES: 42492 MATERIAL NUMBER: SEE CHART CUSTOMER: GENERAL MARKET SHEET NUMBER: 4 OF 7		
ANGULAR TOL ± 0.5 °						

DOCUMENT STATUS	P1	RELEASE DATE	2019/03/15	05:07:15
-----------------	----	--------------	------------	----------

D	OPTIONS	Group	A-42492-0289/0302	Group	A-42492-0303/0318	Group	A-42492-0019/0035	Group	A-42492-0400/0416
		Header No:	41790-0039/0052	Header No:	41790-0037/0052	Header No:	41790-0036/0052	Header No:	41790-0036/0052
		Pin No:	43294-0572	Pin No:	43294-0572	Pin No:	43294-0573	Pin No:	43294-0500
		Plating:	197 - TIN	Plating:	197 - TIN	Plating:	241 - GOLD	Plating:	197 - TIN
		Pin Length L	27.94/1.100	Pin Length L	27.94/1.100	Pin Length L	27.94/1.100	Pin Length L	26.16/ 1.030
		Mating M	11.43 / .450	Mating M	11.43/.450	Mating M	11.43/.450	Mating M	11.38/.448
		Gold Loc G	N/A	Gold Loc G	N/A	Gold Loc G	6.85/ .270	Gold Loc G	N/A
		Dim. Y	5.41/ .213	Dim. Y	5.41/ .213	Dim. Y	5.41/ .213	Dim. Y	5.41/ .213
		PC Tail P	3.96 / .156	PC Tail P	3.96/ .156	PC Tail P	3.96/.156	PC Tail P	2.23/ .088
		Tin Loc T	OVERALL	Tin Loc T	OVERALL	Tin Loc T	5.08/ .200	Tin Loc T	OVERALL
		Voided Ckts	5	Voided Ckts	3	Voided CKts	NONE	Voided Ckts	NONE
		Pack Per	PK-42492-002	Pack Per	PK-42492-002	Pack Per	PK-42492-002	Pack Per	PK-42492-002
Ckts	Material No	Engineer Number	Material No	Engineer Number	Material No	Engineer Number	Material No	Engineer Number	
2					26-65-5020	A-42492-0019	42492-0400	A-42492-0400	
3			42492-0303	A-42492-0303	26-65-5030	A-42492-0020	42492-0401	A-42492-0401	
4			42492-0304	A-42492-0304	26-65-5040	A-42492-0021	42492-0402	A-42492-0402	
5	42492-0289	A-42492-0289	42492-0305	A-42492-0305	26-65-5050	A-42492-0022	42492-0403	A-42492-0403	
6	42492-0290	A-42492-0290	42492-0306	A-42492-0306	26-65-5060	A-42492-0023	42492-0404	A-42492-0404	
7	42492-0291	A-42492-0291	42492-0307	A-42492-0307	26-65-5070	A-42492-0024	42492-0405	A-42492-0405	
8	42492-0292	A-42492-0292	42492-0308	A-42492-0308	26-65-5080	A-42492-0025	42492-0406	A-42492-0406	
9	42492-0293	A-42492-0293	42492-0309	A-42492-0309	26-65-5090	A-42492-0026	42492-0407	A-42492-0407	
10	42492-0294	A-42492-0294	42492-0310	A-42492-0310	26-65-5100	A-42492-0027	42492-0408	A-42492-0408	
11	42492-0295	A-42492-0295	42492-0311	A-42492-0311	26-65-5110	A-42492-0028	42492-0409	A-42492-0409	
12	42492-0296	A-42492-0296	42492-0312	A-42492-0312	26-65-5120	A-42492-0029	42492-0410	A-42492-0410	
13									
14									
15									
16									
17									
18									

THIS DRAWING CONTAINS INFORMATION THAT IS PROPRIETARY TO MOLEX ELECTRONIC TECHNOLOGIES, LLC AND SHOULD NOT BE USED WITHOUT WRITTEN PERMISSION

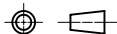
DIMENSION UNITS	SCALE	CURRENT REV DESC: REMASTERED IN NX					
mm	2:1						
GENERAL TOLERANCES (UNLESS SPECIFIED)		EC NO: 613774		KK .156 HEADER ASSEMBLY FRICTION LOCK RT ANGLE WITH PEGS			
	MM	INCH	DRWN: SS06	2019/03/08			
4 PLACES	±	±	CHK'D: ISHWARG	2019/03/15			
3 PLACES	±	± 0.01	APPR: ISHWARG	2019/03/15			
2 PLACES	±	± 0.015	INITIAL REVISION:				
1 PLACE	±	±	DRWN: JSCHAFFER	11-25-03			
0 PLACES	±	±	APPR: MARGULIS	12-1-03			
ANGULAR TOL		± 0.5 °	PRODUCT CUSTOMER DRAWING				
DRAFT WHERE APPLICABLE MUST REMAIN WITHIN DIMENSIONS		THIRD ANGLE PROJECTION	DRAWING	SERIES	MATERIAL NUMBER	CUSTOMER	SHEET NUMBER
			A-SIZE	42492	SEE CHART	GENERAL MARKET	5 OF 7

DOCUMENT STATUS	P1	RELEASE DATE	2019/03/15	05:07:15
-----------------	----	--------------	------------	----------

FORMATT: Eng\lega-master-ib-prod-A
REVISION: D
DATE: 2018/01/18

OPTIONS	Group	A-42492-0417/0431	Group	A-42492-0432/0443	Group	A-42492-0444/0456	Group	A-42492-0461/0473
	Header No:	41790-0036/0052	Header No:	41790-0041/0052	Header No:	41790-0040/0052	Header No:	41790-0040/0052
	Pin No:	43294-0572	Pin No:	43294-0572	Pin No:	43294-0572	Pin No:	43294-0572
	Plating:	197 - TIN	Plating:	197 - TIN	Plating:	197 - TIN	Plating:	197 - TIN
	Pin Length L	27.94/1.100	Pin Length L	27.94/1.100	Pin Length L	27.94/1.100	Pin Length L	27.94/1.100
	Mating M	11.43 / .450	Mating M	11.43/.450	Mating M	11.43/.450	Mating M	11.43/.450
	Gold Loc G	N/A	Gold Loc G	N/A	Gold Loc G	N/A	Gold Loc G	N/A
	Dim. Y	5.41/ .213	Dim. Y	5.41/ .213	Dim. Y	5.41/ .213	Dim. Y	5.41/ .213
	PC Tail P	3.96 / .156	PC Tail P	3.96/ .156	PC Tail P	3.96/.156	PC Tail P	3.96/.156
	Tin Loc T	OVERALL	Tin Loc T	OVERALL	Tin Loc T	OVERALL	Tin Loc T	OVERALL
	Voided Ckts	2, 4	Voided Ckts	1,4,5,6,7	Voided CKts	3, 6	Voided Ckts	4, 6
	Pack Per	PK-42492-002	Pack Per	PK-42492-002	Pack Per	PK-42492-002	Pack Per	PK-42492-002
Ckts	Material No	Engineer Number	Material No	Engineer Number	Material No	Engineer Number	Material No	Engineer Number
2								
3								
4	42492-0417	A-42492-0417						
5	42492-0418	A-42492-0418						
6	42492-0419	A-42492-0419			42492-0444	A-42492-0444		
7	42492-0420	A-42492-0420	42492-0432	A-42492-0432	42492-0445	A-42492-0445	42492-0462	A-42492-0462
8	42492-0421	A-42492-0421	42492-0433	A-42492-0433	42492-0446	A-42492-0446		
9	42492-0422	A-42492-0422	42492-0434	A-42492-0434	42492-0447	A-42492-0447		
10	42492-0423	A-42492-0423	42492-0435	A-42492-0435	42492-0448	A-42492-0448		
11	42492-0424	A-42492-0424	42492-0436	A-42492-0436	42492-0449	A-42492-0449		
12	42492-0425	A-42492-0425	42492-0437	A-42492-0437	42492-0450	A-42492-0450		
13								
14								
15								
16								
17								
18								

THIS DRAWING CONTAINS INFORMATION THAT IS PROPRIETARY TO MOLEX ELECTRONIC TECHNOLOGIES, LLC AND SHOULD NOT BE USED WITHOUT WRITTEN PERMISSION

DIMENSION UNITS	SCALE	CURRENT REV DESC: REMASTERED IN NX	
mm	2:1		
GENERAL TOLERANCES (UNLESS SPECIFIED)		EC NO: 613774	
	MM	INCH	DRWN: SS06 2019/03/08
4 PLACES ±			2019/03/15
3 PLACES ±		0.01	2019/03/15
2 PLACES ±	0.25	0.015	2019/03/15
1 PLACE ±	0.38		
0 PLACES ±			
ANGULAR TOL ±	0.5 °		INITIAL REVISION:
DRAFT WHERE APPLICABLE MUST REMAIN WITHIN DIMENSIONS		THIRD ANGLE PROJECTION	DRWN: JSCHAFFER 11-25-03
		DRAWING	2019/03/15
		SERIES	12-1-03
		MATERIAL NUMBER	APP: MARGULIS
		CUSTOMER	
		SHEET NUMBER	

molex

KK .156 HEADER ASSEMBLY
FRICTION LOCK RT ANGLE WITH PEGS

PRODUCT CUSTOMER DRAWING

DOCUMENT NUMBER	DOC TYPE	DOC PART	REVISION
SD-42492-001	PSD	001	G2

FORMATT: Eng\lega-master-ib-prod-A
REVISION: D
DATE: 2018/01/18

OPTIONS	Group	A-42492-0474	Group	A-42492-0490	Group		Group	
	Header No:	41790-0040/0052	Header No:	41790-0037/0052	Header No:		Header No:	
	Pin No:	43294-0571	Pin No:	43294-0569	Pin No:		Pin No:	
	Plating:	154 - TIN	Plating:	208 - 15 GOLD	Plating:		Plating:	
	Pin Length L	27.94/1.100	Pin Length L	27.94/1.100	Pin Length L		Pin Length L	
	Mating M	11.43 / .450	Mating M	11.43/ .450	Mating M		Mating M	
	Gold Loc G	N/A	Gold Loc G	6.86/.270	Gold Loc G		Gold Loc G	
	Dim. Y	5.41/ .213	Dim. Y	5.41/ .213	Dim. Y		Dim. Y	
	PC Tail P	3.96 / .156	PC Tail P	3.96/ .156	PC Tail P		PC Tail P	
	Tin Loc T	OVERALL	Tin Loc T	5.08 / .200	Tin Loc T		Tin Loc T	
	Voided Ckts	2, 5, 6	Voided Ckts	3	Voided Ckts		Voided Ckts	
	Pack Per	PK-42492-002	Pack Per	PK-42492-002	Pack Per		Pack Per	
Ckts	Material No	Engineer Number	Material No	Engineer Number	Material No	Engineer Number	Material No	Engineer Number
2								
3								
4								
5								
6								
7	42492-0474	A-42492-0474						
8								
9			42492-0490	A-42492-0490				
10								
11								
12								
13								
14								
15								
16								
17								
18								

THIS DRAWING CONTAINS INFORMATION THAT IS PROPRIETARY TO MOLEX ELECTRONIC TECHNOLOGIES, LLC AND SHOULD NOT BE USED WITHOUT WRITTEN PERMISSION

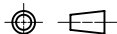
DIMENSION UNITS	SCALE	CURRENT REV DESC: REMASTERED IN NX					
mm	2:1						
GENERAL TOLERANCES (UNLESS SPECIFIED)		EC NO: 613774		KK .156 HEADER ASSEMBLY FRICTION LOCK RT ANGLE WITH PEGS			
	MM	INCH	DRWN: SS06	2019/03/08			
4 PLACES	±	±	CHK'D: ISHWARG	2019/03/15			
3 PLACES	±	± 0.01	APPR: ISHWARG	2019/03/15			
2 PLACES	±	± 0.015	INITIAL REVISION:				
1 PLACE	±	±	DRWN: JSCHAFFER	11-25-03			
0 PLACES	±	±	APPR: MARGULIS	12-1-03			
ANGULAR TOL		± 0.5 °	DRAFT WHERE APPLICABLE MUST REMAIN WITHIN DIMENSIONS				
		THIRD ANGLE PROJECTION	DRAWING	SERIES	MATERIAL NUMBER	CUSTOMER	SHEET NUMBER
			A-SIZE	42492	SEE CHART	GENERAL MARKET	7 OF 7

PRODUCT CUSTOMER DRAWING		
DOCUMENT NUMBER	DOC TYPE	DOC PART
SD-42492-001	PSD	001
REVISION	G2	

DOCUMENT STATUS	P1	RELEASE DATE	2019/03/15	05:07:15
-----------------	----	--------------	------------	----------

FORMATT: Eng\lega-master-ib-prod-A
 REVISION: D
 DATE: 2018/01/18