



## 20DAWE4\_1.5 series

20W - Single/Dual Output - Wide Input - Isolated & Regulated DC-DC Converter

## DC-DC Converter 20 Watt

- ⊕ Ultra-wide 4:1 input voltage range
- ⊕ High efficiency up to 90%
- ⊕ No-load power consumption as low as 0.15W
- ⊕ I/O isolation test voltage 1.5kVDC
- ⊕ Input under-voltage protection, output shortcircuit, over-voltage, over-current protection
- ⊕ Operating ambient temp. range: -40°C to +85°C
- ⊕ Meets CISPR32/EN55032 CLASS A, without extra components
- ⊕ Six-sided metal shielding package
- ⊕ Input reverse polarity protection (with chassis or Din-Rail mounting version)
- ⊕ IEC60950, UL60950, EN60950 approved
- ⊕ Meets EN50155 railway standard
- ⊕ Meets EN62368 standard

The 20DAWE4\_1.5 series of isolated 20W DC-DC products with an ultra 4:1 input voltage range. They feature efficiencies up to 90%, input to output isolation is tested with 1500VDC, operating ambient temperature range of -40°C to +85°C, input under-voltage protection, output short-circuit, over-voltage, over-current protection.

They meet CLASS A of CISPR32/EN55032 standards without extra components, optional packages are offered for chassis or DIN-rail mounting, adding additional input reverse polarity protection and they are widely used in applications such as data transmission device, battery power supplies, telecommunication device, distributed power supply system, hybrid module system, remote control system, industrial robot system and railway fields.



### Common specifications

Short circuit protection:	Hiccup, continous, self recovery
Operation temperature:	-40°C~+85°C (See Fig. 1)
Storage temperature:	-55°C~+125°C
Storage humidity:	5% MIN, 95% MAX (Non-condensing)
Lead temperature:	300°C MAX, 1.5mm from case for 10 sec
Vibrating:	10-55Hz, 10G, 30 Min. along X, Y and Z
Switching frequency: *	270kHz TYP, PWM mode
MTBF:	1000 K hours MIN ((MIL-HDBK-217F@25°C))
Case material:	Aluminium alloy
Cooling:	Free air convection
Dimensions:	<ul style="list-style-type: none"> <li>• Horizontal: 50.80 × 25.40 × 11.80 mm (51.40 × 26.20 × 16.50 mm with heatsink)</li> <li>• Chassis mounting: 76.00 × 31.50 × 21.20 mm (76.00 × 31.50 × 25.30 mm with heatsink)</li> <li>• Din-rail mounting 76.00 × 31.50 × 25.80 mm (76.00 × 31.50 × 29.90 mm with heatsink)</li> </ul>
Weight:	<ul style="list-style-type: none"> <li>• Horizontal: 26g (34g with heatsink) ; TYP.</li> <li>• Chassis mounting: 48g (56g with heatsink); TYP.</li> <li>• Din-rail mounting: 68g (76g with heatsink) ; TYP.</li> </ul>

### Isolation specifications

Item	Test condition	Min	Typ	Max	Units
Isolation voltage	Tested for 1 minute and leakage current less than 1 mA	1500			VDC
Isolation resistance	Test at 500VDC	1000			MΩ
Isolation capacitance	100KHz/0.1V		2050		pF
	• 20DAWE4_2424S1.5		1050		pF
	• others				pF

### Example:

**20DAWE4\_2415S1.5**  
 20 = 20Watt; D = DIP; A = series; E = Cost effective; W4 = wide input (4:1); 15Vout; S = single output; 1.5 = 1500VDC isolation

### Input specifications

Item	Test condition	Min	Typ	Max	Units
Input current (full load/no load)	• 24VDC input - 3.3V output - 5V output - others		799/40	818/45	mA
			969/40	993/45	mA
			947/6	969/10	mA
	• 48VDC input - 3.3V output - 5V output - others		400/20	409/25	mA
			485/20	497/25	mA
			474/5	485/9	mA
Reflected ripple current	• 24VDC input		30		mA
	• 48VDC input		30		mA
Input surge voltage (1000 ms. MAX)	• 24VDC input	-0.7		50	VDC
	• 48VDC input	-0.7		100	VDC
Start-up voltage	• 24VDC input • 48VDC input			9	VDC
				18	VDC
Input Under-voltage Protection	• 24VDC input • 48VDC input	5.5	6.5		VDC
		12	15.5		VDC
Start-up time	Nominal input & constant resistance load		10		ms
Input filter	Pi filter				
Ctrl <sup>(1)</sup>	• Models ON				Ctrl pin open or pulled high (3.5-12VDC)
	• Models OFF				Ctrl pin pulled low to GND (0-1.2VDC)
	• Input current (Models OFF)		4	7	mA
Hot plug	Unavailable				

Note: \*The Ctrl pin voltage is referenced to input GND.

### Note:

- The recommended unbalance degree of the dual output module load is  $\pm 5\%$ ; if the degree exceeds  $\pm 5\%$ , than the product performance cannot be guaranteed to comply with all parameters in the datasheet. Please contact our technicians directly for specific information;
- The maximum capacitive load offered were tested at input voltage range and full load;
- Unless otherwise specified, parameters in this datasheet were measured under the conditions of  $T_a = 25^\circ\text{C}$ , humidity  $< 75\% \text{RH}$  with nominal input voltage and rated output load;
- All index testing methods in this datasheet are based on Company's corporate standards;
- We can provide product customization service, please contact our technicians directly for specific information;
- Specifications are subject to change without prior notice.

## 20DAWE4\_1.5 series

20W - Single/Dual Output - Wide Input - Isolated & Regulated DC-DC Converter

Output specifications					
Item	Test condition	Min	Typ	Max	Units
voltage accuracy <sup>1)</sup>	0%-100% load		±1	±3	%
Line regulation	Full load, Input voltage from low to high • positive output • negative output		±0.2 ±0.5	±0.5 ±1	% %
Load regulation <sup>2)</sup>	5% to 100% load • positive output • negative output		±0.5 ±0.5	±1 ±1.5	% %
Cross regulation	Dual output, main output 50% load, supplement output 10% to 100% load			±5	%
Transient recovery time	25% load step change		300	500	µs
Transient response deviation	25% load step change • 3.3V/5V/±5V output • others		±5 ±3	±8 ±5	% %
Temperature drift	full load			±0.03	%/°C
Ripple & Noise <sup>3)</sup>	20MHz Bandwidth 5%-100% load		50	100	mVp-p
Trim	Input voltage range		±10%		%Vo
Over Voltage Protection	Input voltage range	110		160	%Vo
Over current protection	Input voltage range	110		190	%Io

<sup>1)</sup> Output voltage accuracy of ±5VDC/±9VDC output converter for 0%-5% load is ±5% max;

<sup>2)</sup> Load regulation for 0%-100% load is ±5%;

<sup>3)</sup> Ripple & Noise at ≤ 5% load is 5%Vo. Max. The "parallel cable" method is used for Ripple and Noise test, please refer to DC-DC Converter Application Notes for specific information.

EMC specifications					
Emissions	CE	CISPR32/EN55032 CLASS A (without extra components)/ CLASS B (see Fig.3-② for recommended circuit)			
Emissions	RE	CISPR32/EN55032 CLASS A (without extra components)/ CLASS B (see Fig.3-② for recommended circuit)			
Immunity	ESD	IEC/EN61000-4-2	Contact ±4KV	perf. Criteria B	
Immunity	RS	IEC/EN61000-4-3	10V/m	perf. Criteria A	
Immunity	EFT	IEC/EN61000-4-4 ±2KV (see Fig.3-① for recommended circuit)	perf. Criteria B		
Immunity	Surge	IEC/EN61000-4-5 line to line ±2KV (see Fig.3-③ for recommended circuit)	perf. Criteria B		
Immunity	CS	IEC/EN61000-4-6	3 Vr.m.s	perf. Criteria A	
Immunity	Voltage dips, short and interruptions immunity	IEC/EN61000-4-29	0%-70%	perf. Criteria B	

EMC specifications					
Emissions	CE	EN50121-3-2 150kHz-500kHz 99dBµV (see Fig.3-② for recommended circuit) EN55016-2-1 500kHz-30MHz 93dBµV (see Fig.3-② for recommended circuit)			
Emissions	RE	EN50121-3-2 30MHz-230MHz 40dBµV/m at 10m (see Fig.3-② for recommended circuit) EN55016-2-1 230MHz-1GHz 47dBµV/m at 10m (see Fig.3-② for recommended circuit)			
Immunity	ESD	EN50121-3-2	Contact ±6KV/Air ±8KV	perf. Criteria A	
Immunity	RS	EN50121-3-2	20V/m	perf. Criteria A	
Immunity	EFT	EN50121-3-2 ±2kV	5/50ns 5kHz (see Fig.3-③ for recommended circuit)	perf. Criteria A	
Immunity	Surge	EN50121-3-2	line to line ±1KV (42Ω, 0.5µF) (see Fig.3-③ for recommended circuit)	perf. Criteria A	
Immunity	CS	EN50121-3-2	0.15MHz-80MHz 10V r.m.s	perf. Criteria A	

## Product Selection Guide

Part Number	Input Voltage [VDC]		Output Voltage [VDC]	Output Current [mA, Max]	Efficiency [%, Typ.]	Capacitive load [µF, Max]	
	Nominal	Range Max <sup>(1)</sup>					
20DAWE4_2403S1.5	24	9-36	40	3.3	5000	84/86	10000
20DAWE4_2405S1.5	24	9-36	40	5	4000	86/88	10000
20DAWE4_2409S1.5	24	9-36	40	9	2222	87/89	4700
20DAWE4_2412S1.5	24	9-36	40	12	1667	87/89	1600
20DAWE4_2415S1.5	24	9-36	40	15	1333	88/90	1000
20DAWE4_2424S1.5	24	9-36	40	24	834	88/90	500
20DAWE4_4803S1.5	48	18-75	80	3.3	5000	84/86	10000
20DAWE4_4805S1.5	48	18-75	80	5	4000	84/86	10000
20DAWE4_4809S1.5	48	18-75	80	9	2222	87/89	4700
20DAWE4_4812S1.5	48	18-75	80	12	1667	85/87	1600
20DAWE4_4815S1.5	48	18-75	80	15	1333	88/90	1000
20DAWE4_4824S1.5	48	18-75	80	24	834	86/88	500

We recommend to choose modules with a heat sink for enhanced heat dissipation and applications with extreme temperature requirements; The specified maximum capacitive load for positive and negative output is identical.

Part Number	Input Voltage [VDC]		Output Voltage [VDC]	Output Current [mA, Max]	Efficiency [%, Typ.]	Capacitive load [µF, Max]	
	Nominal	Range Max <sup>(1)</sup>					
20DAWE4_2405D1.5	24	9-36	40	±5	±2000	84/86	4800
20DAWE4_2409D1.5	24	9-36	40	±9	±1111	86/88	1000
20DAWE4_2412D1.5	24	9-36	40	±12	±834	86/88	800
20DAWE4_2415D1.5	24	9-36	40	±15	±667	86/88	625
20DAWE4_4805D1.5	48	18-75	80	±5	±2000	84/86	4800
20DAWE4_4812D1.5	48	18-75	80	±12	±834	86/88	800
20DAWE4_4815D1.5	48	18-75	80	±15	±667	87/89	625

## 20DAWE4\_1.5 series

20W - Single/Dual Output - Wide Input - Isolated & Regulated  
DC-DC Converter

## Typical characteristics

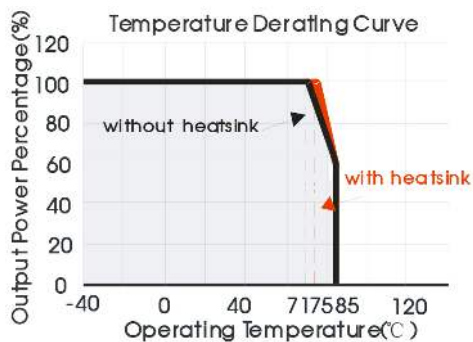
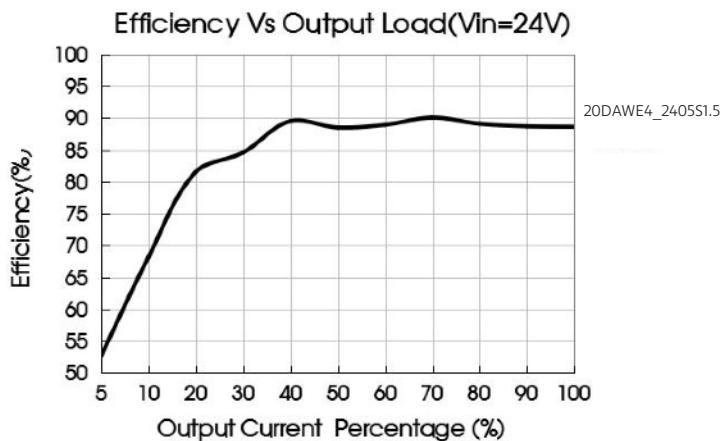
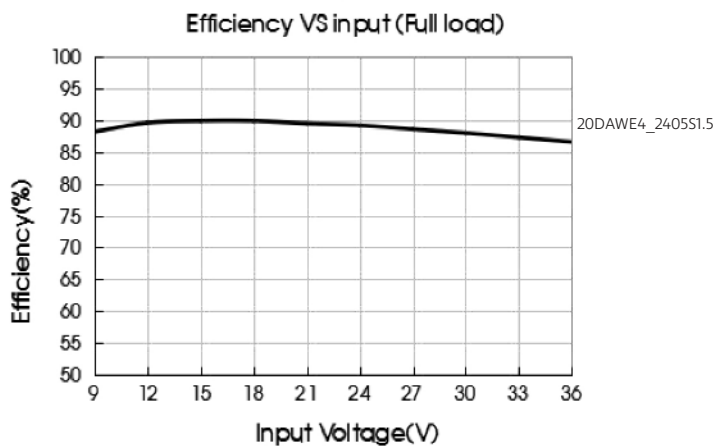
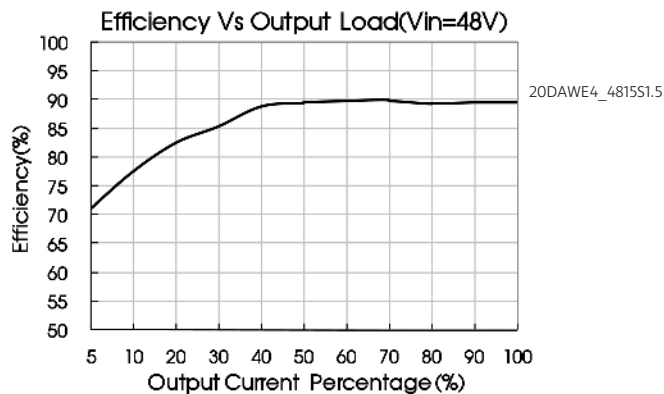
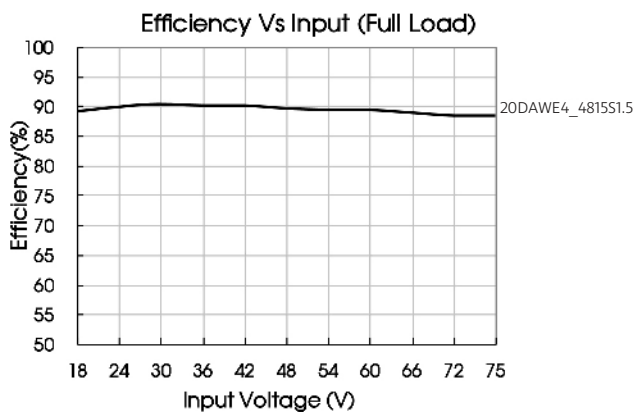

Fig. 1

## Efficiency



## 20DAWE4\_1.5 series

20W - Single/Dual Output - Wide Input - Isolated & Regulated DC-DC Converter

### Typical application

All the DC-DC converters of this series are tested before delivery using the recommended circuit shown in Fig. 2.

Input and/or output ripple can be further reduced by appropriately increasing the input & output capacitor values  $C_{in}$  and  $C_{out}$  and/or by selecting capacitors with a low ESR (equivalent series resistance). Also make sure that the capacitance is not exceeding the specified max. capacitive load value of the product.

$C_{in}$ Vin:24VDC	$C_{in}$ Vin:48VDC	Single Vo (VDC)	$C_{out}$ ( $\mu$ F)	Dual Vout (VDC)	$C_{out}$ ( $\mu$ F)
100 $\mu$ F/50V	100 $\mu$ F/100V	3.3/5	470 $\mu$ F/16V	$\pm$ 5	220 $\mu$ F/16V
		9	220 $\mu$ F/16V	$\pm$ 9	100 $\mu$ F/16V
		12/15	220 $\mu$ F/25V	$\pm$ 12/ $\pm$ 15	100 $\mu$ F/25V
		24	100 $\mu$ F/50V		-

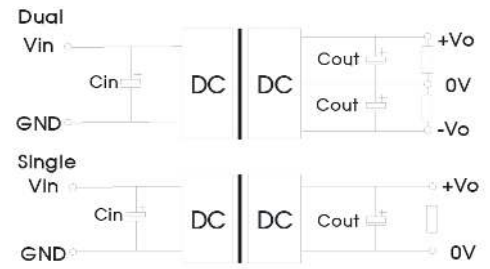
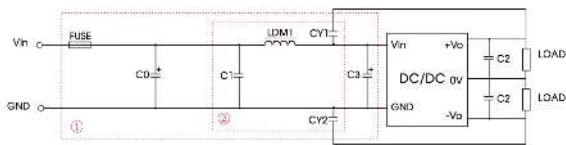

Fig. 2

### EMC recommended circuit

Dual



Single

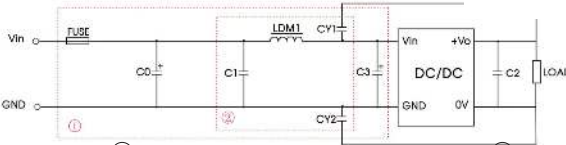

Fig. 3

Notes: We use Part ① in Fig. 3 for Immunity tests and Part ② for Emissions test. Selecting based on needs.

Parameter description:

Model	Vin: 24V	Vin: 48V
FUSE	Choose according to actual input current	
C0/C3	330 $\mu$ F/50V	330 $\mu$ F/100V
C1	1 $\mu$ F/50V	1 $\mu$ F/100V
C2	Refer to the $C_{out}$ in Fig.2	
LDM1	4.7 $\mu$ H/3.1A	
CY1/CY2	1nF/2KV	

### Trim Function for Output Voltage Adjustment (open if unused)

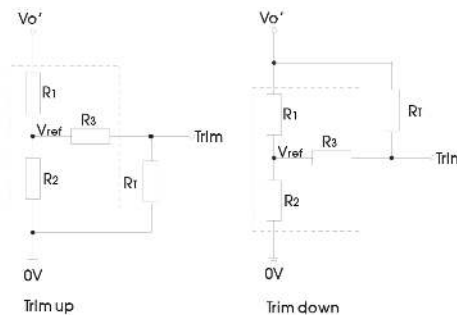

TRIM resistor connection (dashed line shows internal resistor network)

Calculating Trim resistor values:

$$\begin{aligned} \text{up: } R_T &= \frac{\alpha R_2}{R_2 - \alpha} \cdot R_3 & \alpha &= \frac{V_{ref}}{V_o' - V_{ref}} \cdot R_1 \\ \text{down: } R_T &= \frac{\alpha R_1}{R_1 - \alpha} \cdot R_3 & \alpha &= \frac{V_o' - V_{ref}}{V_{ref}} \cdot R_2 \end{aligned}$$

$R_T$  = Trim Resistor value  
 $\alpha$  = self-defined parameter

Vout(V)	R1(K $\Omega$ )	R2(K $\Omega$ )	R3(K $\Omega$ )	Vref(V)
3.3	4.801	2.87	12.4	1.24
5	2.883	2.87	10	2.5
9	7.500	2.87	15	2.5
12	11.000	2.87	15	2.5
15	14.494	2.87	15	2.5
24	24.872	2.87	17.8	2.5

## 20DAWE4\_1.5 series

20W - Single/Dual Output - Wide Input - Isolated & Regulated  
DC-DC Converter

### Mechanical dimensions

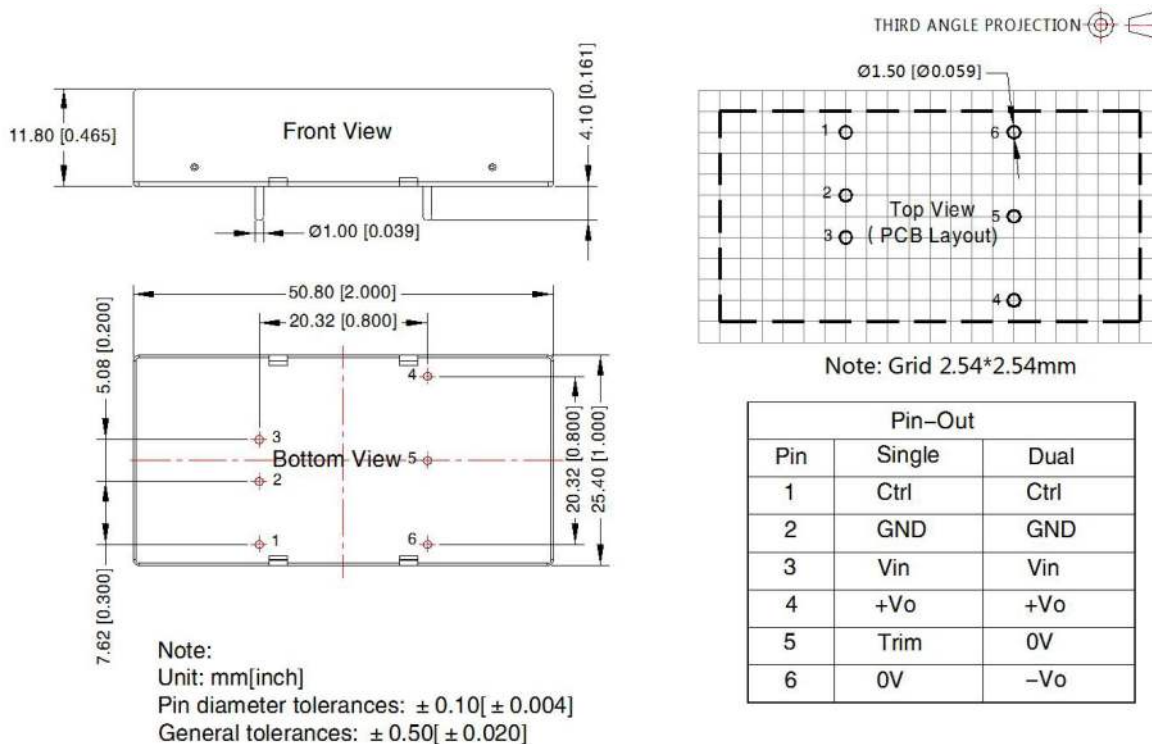

### Mechanical dimensions (with heatsink)

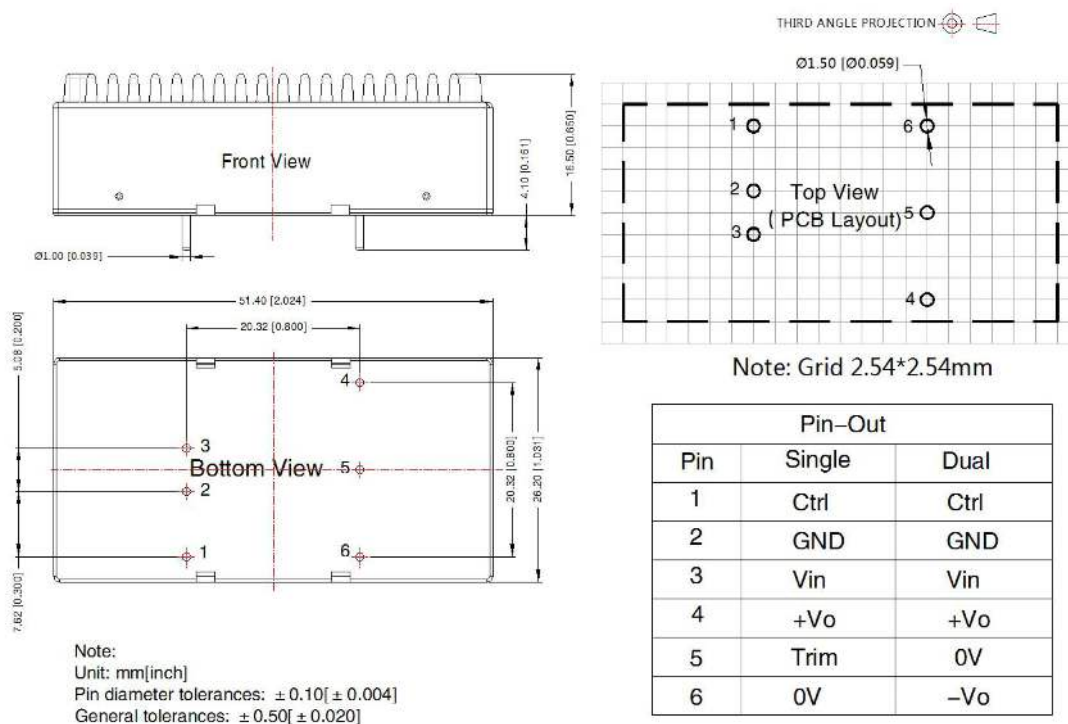

## 20DAWE4\_1.5 series

20W - Single/Dual Output - Wide Input - Isolated & Regulated  
DC-DC Converter

### Mechanical dimensions (chassis mounting)

THIRD ANGLE PROJECTION 

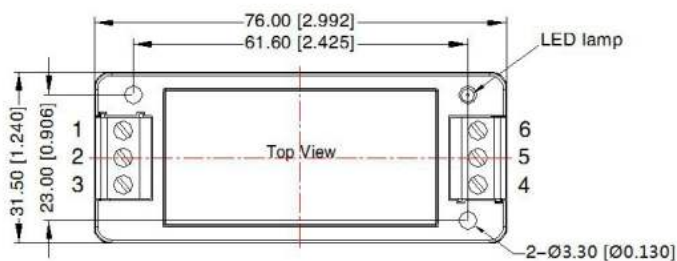

Pin-Out						
Pin	1	2	3	4	5	6
Dual	Ctrl	GND	Vin	+Vo	0V	-Vo
Single	Ctrl	GND	Vin	+Vo	Trim	0V

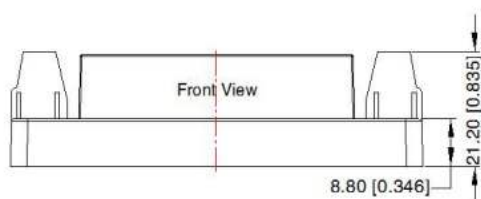

Note:  
 Unit: mm[inch]  
 Wire range: 24-12 AWG  
 Tightening torque: Max 0.4 N · m  
 General tolerances: ± 1.0 [± 0.039]

### Mechanical dimensions (chassis mounting, with heatsink)

THIRD ANGLE PROJECTION 

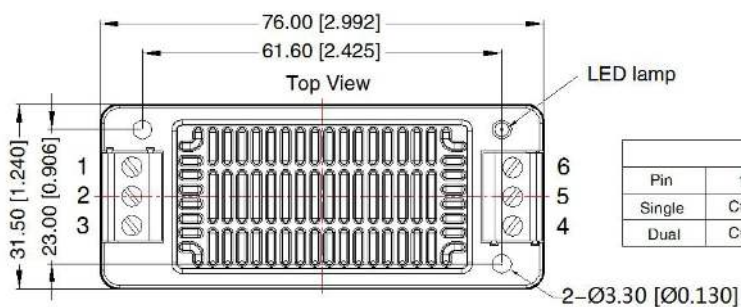

Pin-Out						
Pin	1	2	3	4	5	6
Single	Ctrl	GND	Vin	+Vo	Trim	0V
Dual	Ctrl	GND	Vin	+Vo	0V	-Vo

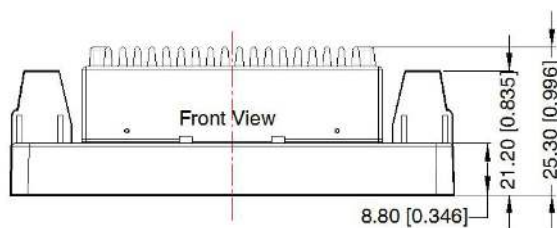

Note:  
 Unit: mm[inch]  
 Wire range: 24-12 AWG  
 Tightening torque: Max 0.4 N · m  
 General tolerances: ± 1.0 [± 0.039]

## 20DAWE4\_1.5 series

20W - Single/Dual Output - Wide Input - Isolated & Regulated  
DC-DC Converter

### Mechanical dimensions (Din-rail mounting)

THIRD ANGLE PROJECTION 

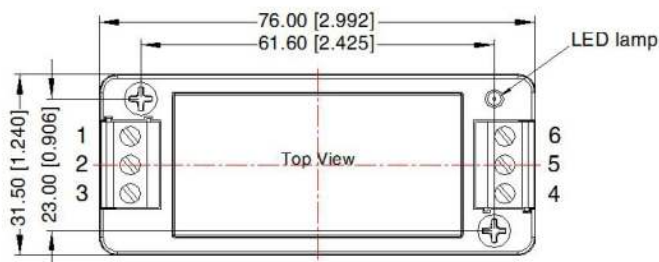

Pin-Out						
Pin	1	2	3	4	5	6
Dual	Ctrl	GND	Vin	+Vo	0V	-Vo
Single	Ctrl	GND	Vin	+Vo	Trim	0V

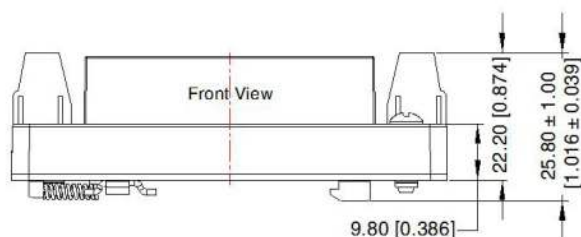

Note:

Unit: mm[inch]

Mounting rail: TS35

Wire range: 24-12 AWG

Tightening torque: Max 0.4 N · m

General tolerances: ± 1.00 [± 0.039]

### Mechanical dimensions (Din-rail mounting, with heatsink)

THIRD ANGLE PROJECTION 

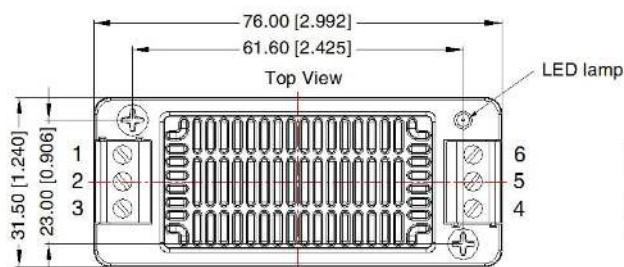

Pin-Out						
Pin	1	2	3	4	5	6
Single	Ctrl	GND	Vin	+Vo	Trim	0V
Dual	Ctrl	GND	Vin	+Vo	0V	-Vo

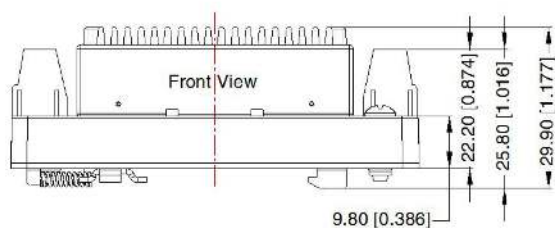

Note:

Unit: mm[inch]

Mounting rail: TS35

Wire range: 24-12 AWG

Tightening torque: Max 0.4 N · m

General tolerances: ± 1.00 [± 0.039]