

Features

- 20 V to 50 V Back Bias
- 200 mA Sinking Current
- 100 mA Sourcing Current
- Propagation Delay <200 ns Driving 100 pF Capacitive Load
- Low Quiescent Current
- 3.3 V TTL Logic Control
- 3 mm 16-Lead PQFN Package
- Halogen-Free “Green” Mold Compound
- RoHS* Compliant

Description

The MADR-009150 switch driver is designed to work with MACOM’s high power and high voltage PIN diode switches. This driver has complementary outputs which can provide up to 200 mA bias current to a SPDT PIN diode switch. The back bias voltage can be selected to be any voltage between 20 V to 50 V. This switch driver can be easily controlled by standard 3.3 V TTL logic. With low quiescent current, this driver has a typical delay of <200 ns when driving 100 pF capacitive load.

This driver is packaged in a lead free 3 mm 16-lead PQFN package and is available in tape and reel packaging for high volume applications.

Ordering Information¹

Part Number	Package
MADR-009150	bulk
MADR-009150-TR1000	1000 Piece Reel

1. Reference Application Note M513 for reel size information.

Functional Schematic

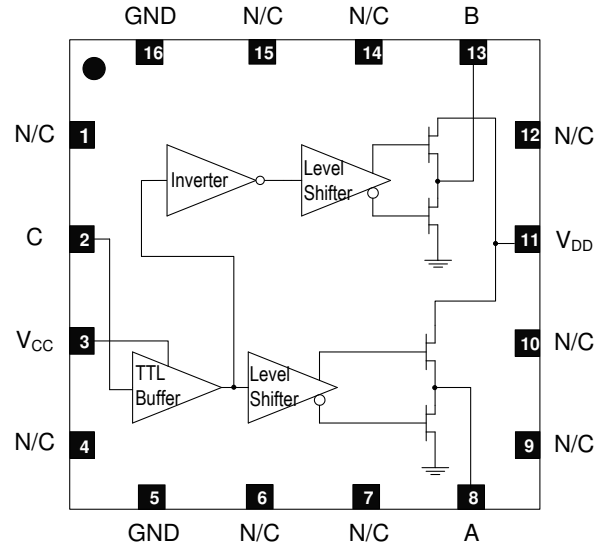

Pin Configuration

Pin No.	Function	Description of Function
1,4	N/C ²	No Connection
2	C	Logic Control Input
3	V _{CC}	Logic Bias
5	GND	Ground
6,7,9,10,12,14,15	N/C ³	No Connection
8	A	Output A
11	V _{DD}	High Voltage Bias
13	B	Output B
16	GND	Ground
17	Paddle ⁴	Ground

- Pin 1 and Pin 4 (N/C) can be grounded if desired.
- Pins 6, 7, 9, 10, 12, 14 and 15 (N/C) should be isolated on the PCB to prevent voltage difference between adjacent pins from exceeding IPC 2221 standard. For V_{DD} peak voltage less than 30 V, these pins can be grounded if desired.
- The exposed pad centered on the package bottom must be connected to the RF, DC and thermal ground.

* Restrictions on Hazardous Substances, European Union Directive 2011/65/EU

Electrical Specifications: $T_A = 25^\circ\text{C}$, $V_{CC} = 3.3\text{ V}$, $V_{DD} = 50\text{ V}$

Parameter	Test Conditions	Units	Min.	Typ.	Max.
V_{CC} Quiescent Current	$C = 3.3\text{ V}$	μA	—	50	—
V_{DD} Quiescent Current	$C = 0\text{ V}$ or 3.3 V	mA	—	0.5	—
Control Input Leakage Current ⁵	$C = 3.3\text{ V}$	μA	—	25	—
$R_{\text{PULL-UP}}$, Output Pull-up On Resistance	100 mA Load	Ω	—	19	—
$R_{\text{PULL-DOWN}}$, Output Pull-down On Resistance	200 mA Load	Ω	—	6	—
Switching Speed Driving 100 pF Capacitors ⁶ T_{ON} T_{OFF} T_{RISE} T_{FALL}	50% control to 90% Voltage 50% control to 10% Voltage 10% to 90% Voltage 90% to 10% Voltage	ns	—	120 140 30 30	—
Switching Speed Driving the MASW-000936 Switch ⁷ T_{ON} T_{OFF} T_{RISE} T_{FALL}	50% control to 90% RF 50% control to 10% RF 50% control to 90% RF 50% control to 10% RF	ns	—	320 300 420 160	—
Driver Power Up Time	Note 8	μs	—	30	—
Driver Power Down Time	Note 9	μs	—	500	—

5. This leakage current is due to an active pull-down NMOS FET at the control input.
6. During this test, there was 100 pF capacitive load at each output (no current load).
7. MACOM MASW-000936 is a 120 W SPDT PIN diode switch requiring 100 mA current to bias series and shunt diodes. These results were measured with a 2.7 GHz, 9.5 dBm sine wave signal.
8. The driver power up time is the time needed for the internal bias voltages to reach 90% of their steady state value during power up.
9. The driver power down time is the time needed for the internal voltages to discharge to 10% of their steady state value during power down.

Recommended Operating Conditions

Parameter	Test Conditions	Units	Min.	Typ.	Max.
V_{CC}	—	V	3.0	3.3	3.6
V_{DD}	—	V	20	—	50
C	Logic "0" Logic "1"	V	0.0 2.0	0.0 V_{CC}	0.8 V_{CC}
I_{SINK} , Sinking Current per Output	—	mA	—	—	200
I_{SOURCE} , Sourcing Current per Output	—	mA	—	—	100
Total Capacitive load per Output (Operating)	—	pF	—	—	100
Operating Temperature	—	°C	-40	+25	+85

Absolute Maximum Ratings^{10,11}

Parameter	Absolute Maximum
V_{CC}	$-0.5\text{ V} \leq V_{CC} \leq +5.5\text{ V}$
V_{DD}	$-0.5\text{ V} \leq V_{DD} \leq +55\text{ V}$
C	$-0.5\text{ V} \leq V_{CC} \leq +5.5\text{ V}$
Sinking Current per Output	250 mA
Sourcing Current per Output	125 mA
Capacitive Load per Output ¹²	125 pF
Operating Temperature	-40°C to +110°C
Storage Temperature	-55°C to +150°C

10. Exceeding any one or combination of these limits may cause permanent damage to this device.
 11. MACOM does not recommend sustained operation near these survivability limits.
 12. Capacitive load above 125 pF can cause peak current exceeding power limit for the MOSFETs in the output buffer.

Logic Truth Table

Input C	Output A	Output B
0	$\approx \text{GND}^{13}$	$\approx V_{DD}^{14}$
1	$\approx V_{DD}^{14}$	$\approx \text{GND}^{13}$

13. The actual output low voltage can be calculated by:

$$V_{OL} = I_{SINK} \times R_{PULL-DOWN}$$

14. The actual output high voltage can be calculated by:

$$V_{OH} = V_{DD} - I_{SOURCE} \times R_{PULL-UP}$$

Handling Procedures

Please observe the following precautions to avoid damage:

Static Sensitivity

These electronic devices are sensitive to electrostatic discharge (ESD) and can be damaged by static electricity. Proper ESD control techniques should be used when handling these HBM classification 1C devices.

Typical Performance Curves

Quiescent I_{CC} : $V_{CC} = 3.3\text{ V}$, $V_{DD} = 50\text{ V}$

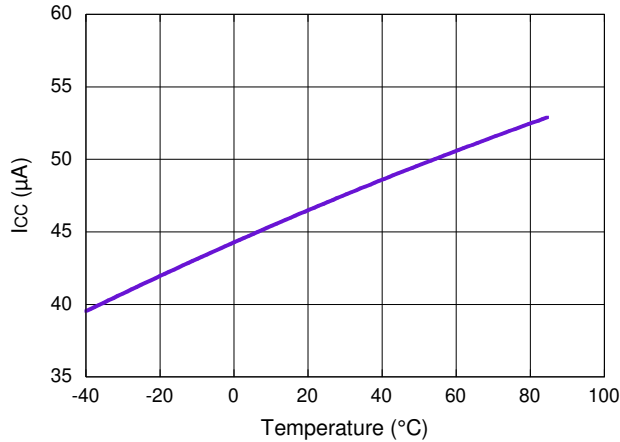

Output Pull-up On Resistance: $V_{CC} = 3.3\text{ V}$

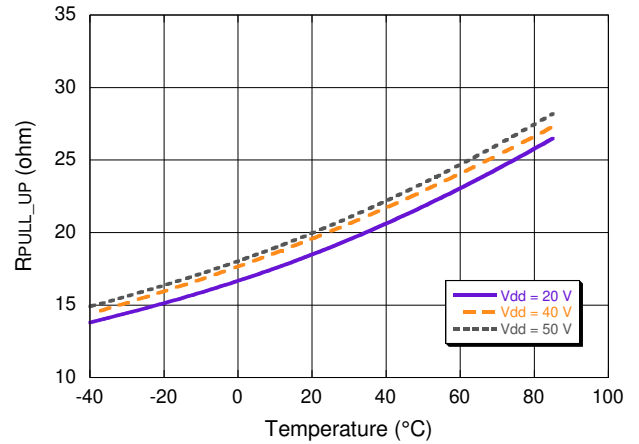

Quiescent I_{DD} : $V_{CC} = 3.3\text{ V}$, $V_{DD} = 50\text{ V}$

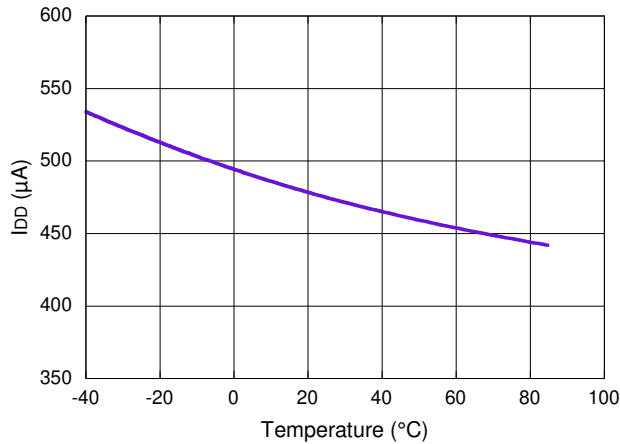

Output Pull-down On Resistance: $V_{CC} = 3.3\text{ V}$

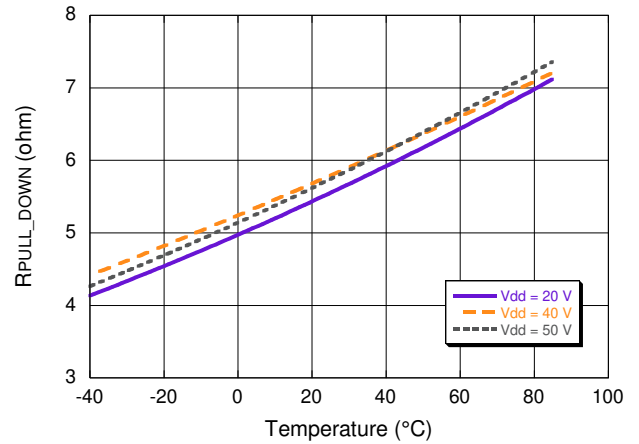

Control Leakage Current: $V_{CC} = 3.3\text{ V}$, $V_{DD} = 50\text{ V}$

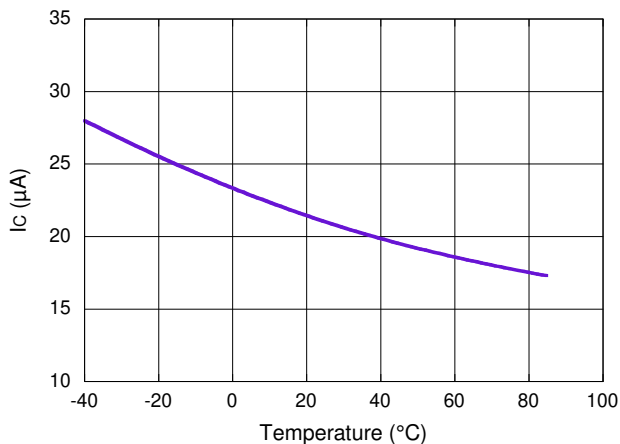

Typical Performance Curves¹⁵

Switching Speed Driving 100 pF Capacitors: T_{ON}

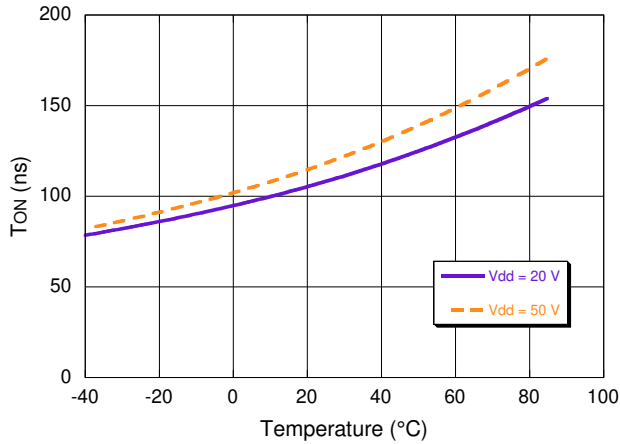

Switching Speed Driving 100 pF Capacitors: T_{OFF}

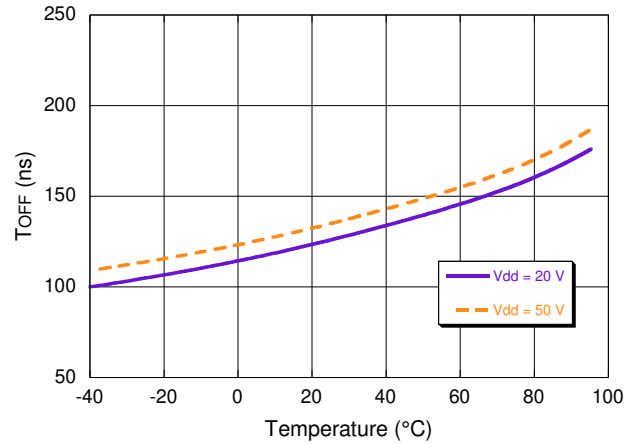

Switching Speed Driving 100 pF Capacitors: T_{RISE}

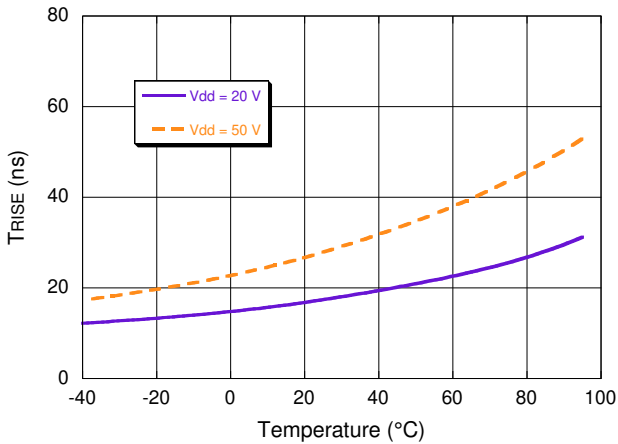

Switching Speed Driving 100 pF Capacitors: T_{FALL}

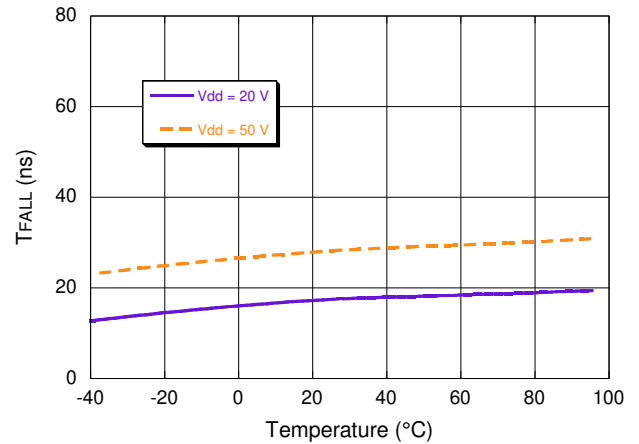

15. During this test, there was 100 pF capacitive load at each output (no current load). $V_{CC} = 3.3$ V. Control input was a 0 V to 3.3 V pulse with rise and fall time of 6 ns.

Typical Performance Curves¹⁶

Switching Speed Driving MASW-000936: T_x ON

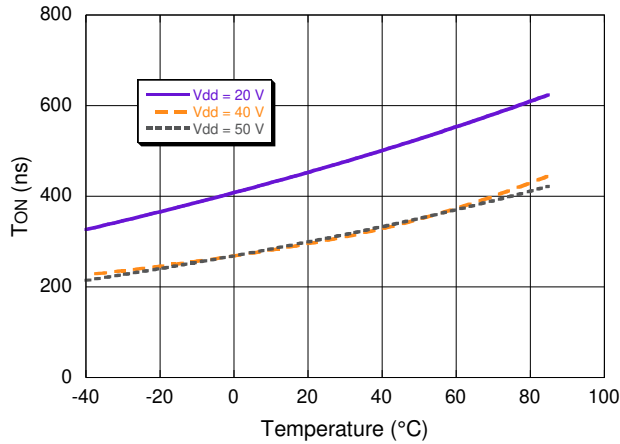

Switching Speed Driving MASW-000936: R_x ON

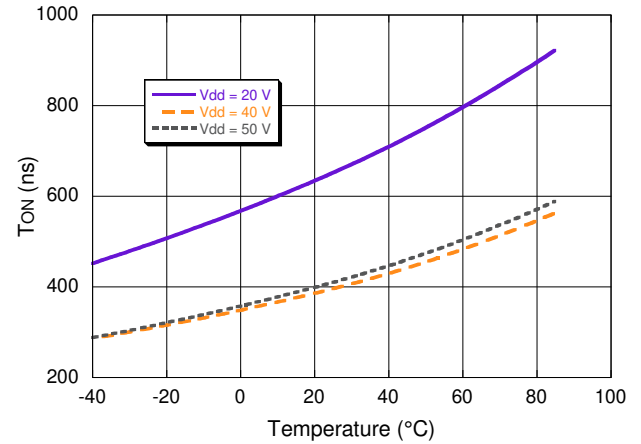

Switching Speed Driving MASW-000936: T_x OFF

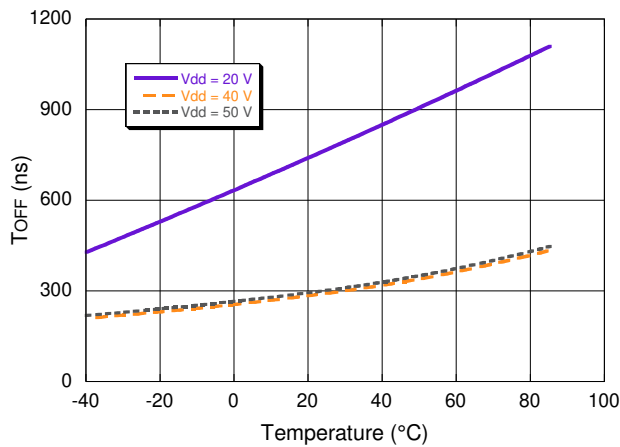

Switching Speed Driving MASW-000936: R_x OFF

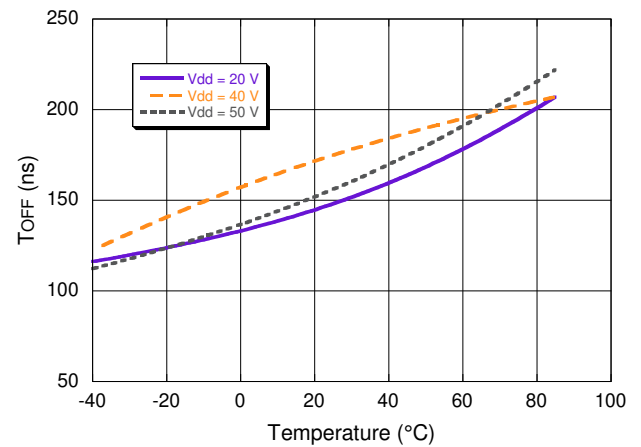

16. MACOM's MASW-000936 is a 120 W SPDT PIN diode switch requiring 100 mA current to bias series and shunt diodes. These results were measured with a 2.7 GHz, 9.5 dBm sine wave signal. Control input was a 0 V to 3.3 V pulse with rise and fall time of 6 ns.

Application Circuit: Driving PIN Diode Switch MASW-00936^{17,18}

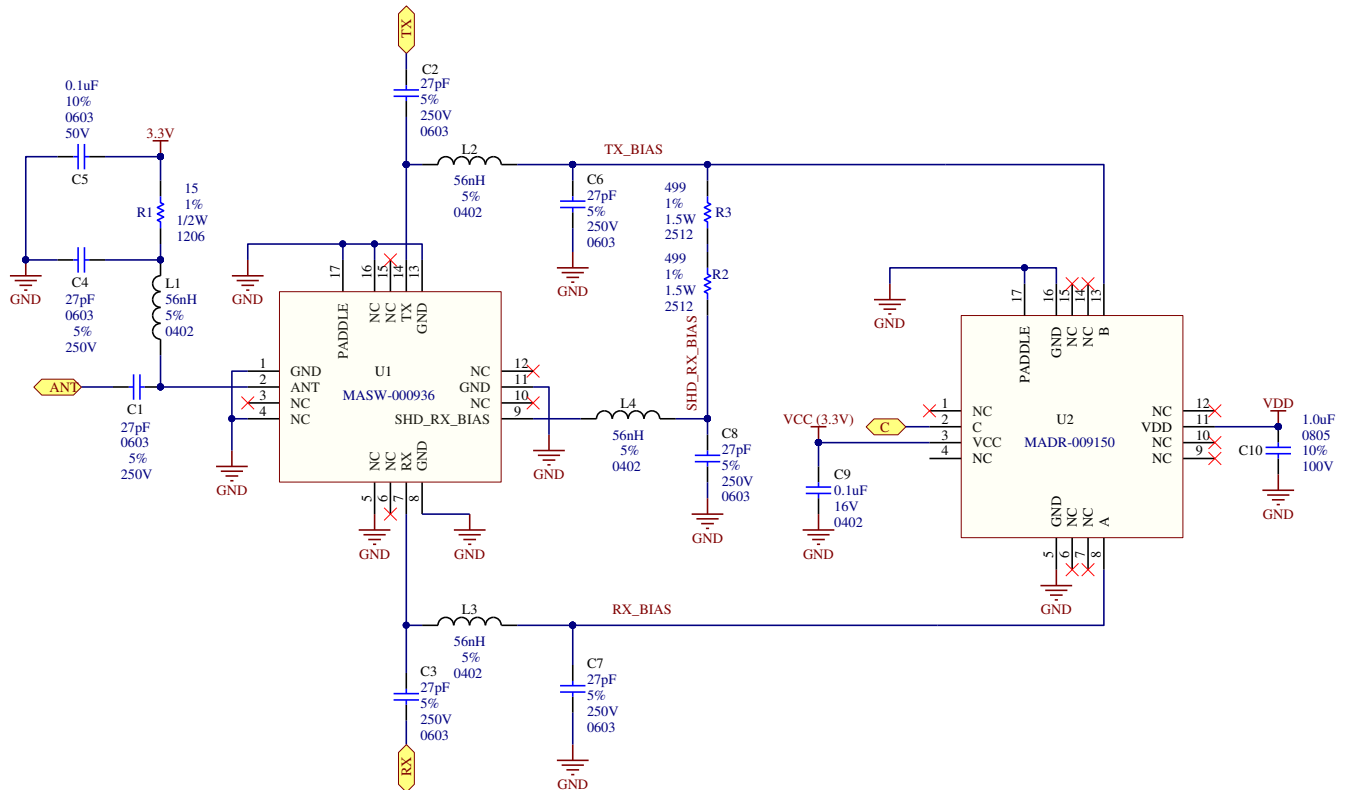

17. This application circuit is configured to bias the series diodes of the MASW-00936 switch with 100 mA current. Shunt diode bias current is depending on the value of V_{DD} . With V_{DD} of 40 V, the shunt diode current is around 38 mA.
18. This driver can also be used to drive a series/shunt, series/shunt, SP2T switch. RX shunt diode bias should be connected to the TX series diode bias as shown in the schematic above. TX shunt diode bias should be connected to the RX series diode bias. To the driver, the sourcing current is the shunt diode forward bias current. The sinking current is the sum of the shunt diode bias current and the series diode bias current.

Lead-Free 3 mm 16-Lead PQFN[†]

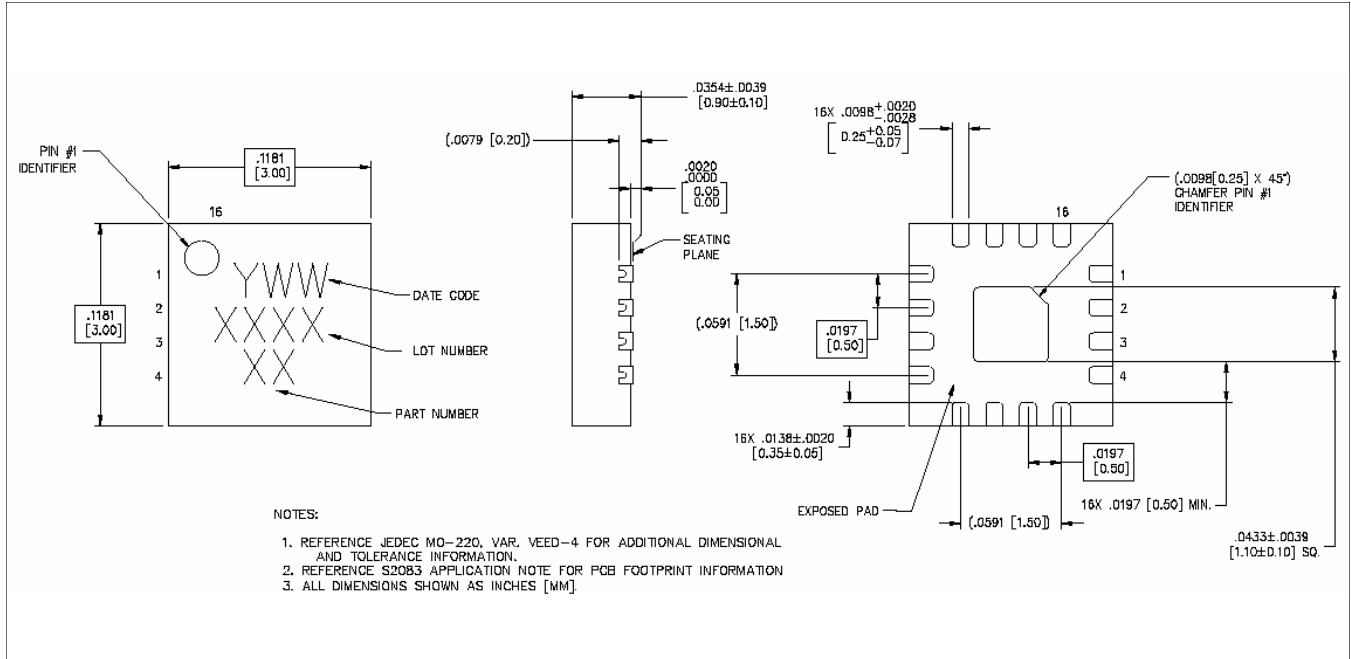

[†] This is not a JEDEC standard package.
 Meets JEDEC moisture sensitivity level 1 requirements.
 Plating is NiPdAu.

MACOM Technology Solutions Inc. All rights reserved.

Information in this document is provided in connection with MACOM Technology Solutions Inc ("MACOM") products. These materials are provided by MACOM as a service to its customers and may be used for informational purposes only. Except as provided in MACOM's Terms and Conditions of Sale for such products or in any separate agreement related to this document, MACOM assumes no liability whatsoever. MACOM assumes no responsibility for errors or omissions in these materials. MACOM may make changes to specifications and product descriptions at any time, without notice. MACOM makes no commitment to update the information and shall have no responsibility whatsoever for conflicts or incompatibilities arising from future changes to its specifications and product descriptions. No license, express or implied, by estoppel or otherwise, to any intellectual property rights is granted by this document.

THESE MATERIALS ARE PROVIDED "AS IS" WITHOUT WARRANTY OF ANY KIND, EITHER EXPRESS OR IMPLIED, RELATING TO SALE AND/OR USE OF MACOM PRODUCTS INCLUDING LIABILITY OR WARRANTIES RELATING TO FITNESS FOR A PARTICULAR PURPOSE, CONSEQUENTIAL OR INCIDENTAL DAMAGES, MERCHANTABILITY, OR INFRINGEMENT OF ANY PATENT, COPYRIGHT OR OTHER INTELLECTUAL PROPERTY RIGHT. MACOM FURTHER DOES NOT WARRANT THE ACCURACY OR COMPLETENESS OF THE INFORMATION, TEXT, GRAPHICS OR OTHER ITEMS CONTAINED WITHIN THESE MATERIALS. MACOM SHALL NOT BE LIABLE FOR ANY SPECIAL, INDIRECT, INCIDENTAL, OR CONSEQUENTIAL DAMAGES, INCLUDING WITHOUT LIMITATION, LOST REVENUES OR LOST PROFITS, WHICH MAY RESULT FROM THE USE OF THESE MATERIALS.

MACOM products are not intended for use in medical, lifesaving or life sustaining applications. MACOM customers using or selling MACOM products for use in such applications do so at their own risk and agree to fully indemnify MACOM for any damages resulting from such improper use or sale.