

NEW PRODUCT

### Features

- Epitaxial Planar Die Construction
- Complementary NPN Type Available (DSS4140V)
- Low Collector-Emitter Saturation Voltage,  $V_{CE(SAT)}$
- Surface Mount Package Suited for Automated Assembly
- Ultra-Small Surface Mount Package
- **Lead Free/RoHS Compliant (Note 1)**
- **"Green Device" (Note 2)**

### Mechanical Data

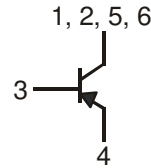
- Case: SOT-563
- Case Material: Molded Plastic, "Green" Molding Compound. UL Flammability Classification Rating 94V-0
- Moisture Sensitivity: Level 1 per J-STD-020D
- Terminals: Finish — Matte Tin annealed over Copper leadframe. Solderable per MIL-STD-202, Method 208
- Marking Information: See Page 4
- Ordering Information: See Page 4
- Weight: 0.003 grams (approximate)



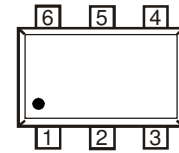
Top View



Bottom View



Device Schematic



Pin Out Configuration

### Maximum Ratings @ $T_A = 25^\circ\text{C}$ unless otherwise specified

Characteristic	Symbol	Value	Unit
Collector-Base Voltage	$V_{CBO}$	-40	V
Collector-Emitter Voltage	$V_{CEO}$	-40	V
Emitter-Base Voltage	$V_{EBO}$	-5	V
Collector Current - Continuous	$I_C$	-1	A
Peak Pulse Collector Current	$I_{CM}$	-2	A
Base Current (DC)	$I_B$	-300	mA
Peak Base Current	$I_{BM}$	-1	A

### Thermal Characteristics

Characteristic	Symbol	Value	Unit
Power Dissipation (Note 3) @ $T_A = 25^\circ\text{C}$	$P_D$	600	mW
Thermal Resistance, Junction to Ambient (Note 3) @ $T_A = 25^\circ\text{C}$	$R_{\theta JA}$	208	$^\circ\text{C}/\text{W}$
Operating and Storage Temperature Range	$T_J, T_{STG}$	-55 to +150	$^\circ\text{C}$

- Notes:
1. No purposefully added lead.
  2. Diode's Inc.'s "Green" policy can be found on our website at [http://www.diodes.com/products/lead\\_free/index.php](http://www.diodes.com/products/lead_free/index.php).
  3. Device mounted on FR-4 PCB with minimum recommended pad layout.

**Electrical Characteristics** @ $T_A = 25^\circ\text{C}$  unless otherwise specified

Characteristic	Symbol	Min	Typ	Max	Unit	Test Condition
<b>OFF CHARACTERISTICS</b>						
Collector-Base Breakdown Voltage	$V_{(BR)CBO}$	-40	—	—	V	$I_C = -100\mu\text{A}, I_E = 0$
Collector-Emitter Breakdown Voltage (Note 4)	$V_{(BR)CEO}$	-40	—	—	V	$I_C = -10\text{mA}, I_B = 0$
Emitter-Base Breakdown Voltage	$V_{(BR)EBO}$	-5	—	—	V	$I_E = -100\mu\text{A}, I_C = 0$
Collector Cutoff Current	$I_{CBO}$	—	—	-100	nA	$V_{CB} = -40\text{V}, I_E = 0$
Collector Cutoff Current	$I_{CES}$	—	—	-100	nA	$V_{CE} = -40\text{V}, V_{EB} = 0$
Emitter Cutoff Current	$I_{EBO}$	—	—	-100	nA	$V_{EB} = -5\text{V}, I_C = 0$
<b>ON CHARACTERISTICS (Note 4)</b>						
DC Current Gain	$h_{FE}$	300	—	—	—	$V_{CE} = -5\text{V}, I_C = -1\text{mA}$
		300	—	800		$V_{CE} = -5\text{V}, I_C = -100\text{mA}$
		250	—	—		$V_{CE} = -5\text{V}, I_C = -500\text{mA}$
		160	—	—		$V_{CE} = -5\text{V}, I_C = 1\text{A}$
Collector-Emitter Saturation Voltage	$V_{CE(SAT)}$	—	—	-140	mV	$I_C = -100\text{mA}, I_B = -1\text{mA}$
		—	—	-170		$I_C = -500\text{mA}, I_B = -50\text{mA}$
		—	—	-310		$I_C = -1\text{A}, I_B = -100\text{mA}$
Collector-Emitter Saturation Resistance	$R_{CE(SAT)}$	—	—	340	m $\Omega$	$I_C = -500\text{mA}, I_B = -50\text{mA}$
Base-Emitter Saturation Voltage	$V_{BE(SAT)}$	—	—	-1.1	V	$I_C = -1\text{A}, I_B = -50\text{mA}$
Base-Emitter Turn On Voltage	$V_{BE(ON)}$	—	—	-1	V	$V_{CE} = -5\text{V}, I_C = -1\text{A}$
<b>SMALL SIGNAL CHARACTERISTICS</b>						
Output Capacitance	$C_{obo}$	—	—	15	pF	$V_{CB} = -10\text{V}, f = 1.0\text{MHz}$
Current Gain-Bandwidth Product	$f_T$	150	—	—	MHz	$V_{CE} = -10\text{V}, I_C = -50\text{mA}, f = 100\text{MHz}$
<b>SWITCHING CHARACTERISTICS</b>						
Turn-On Time	$t_{on}$	—	55	—	ns	$V_{CC} = -10\text{V}$ $I_C = -0.5\text{A}, I_{B1} = I_{B2} = -25\text{mA}$
Delay Time	$t_d$	—	20	—	ns	
Rise Time	$t_r$	—	35	—	ns	
Turn-Off Time	$t_{off}$	—	255	—	ns	
Storage Time	$t_s$	—	225	—	ns	
Fall Time	$t_f$	—	30	—	ns	

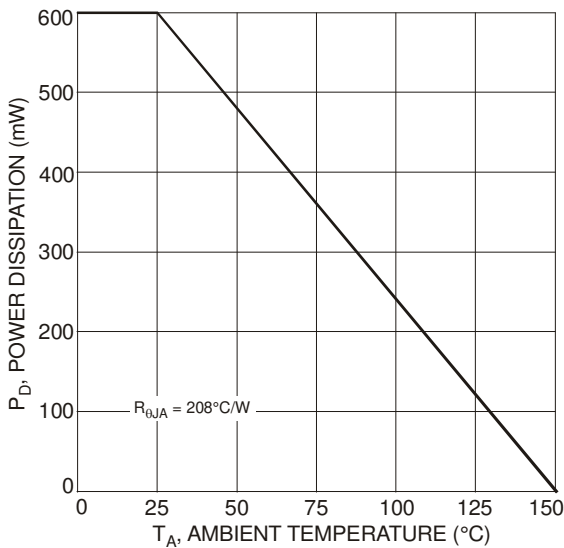
 Notes: 4. Measured under pulsed conditions. Pulse width = 300 $\mu\text{s}$ . Duty cycle  $\leq 2\%$ .


Fig. 1 Power Dissipation vs. Ambient Temperature (Note 3)

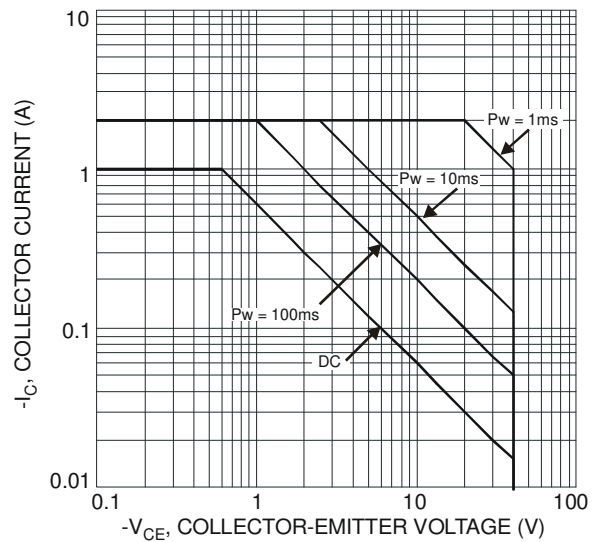


Fig. 2 Typical Collector Current vs. Collector-Emitter Voltage (Note 3)

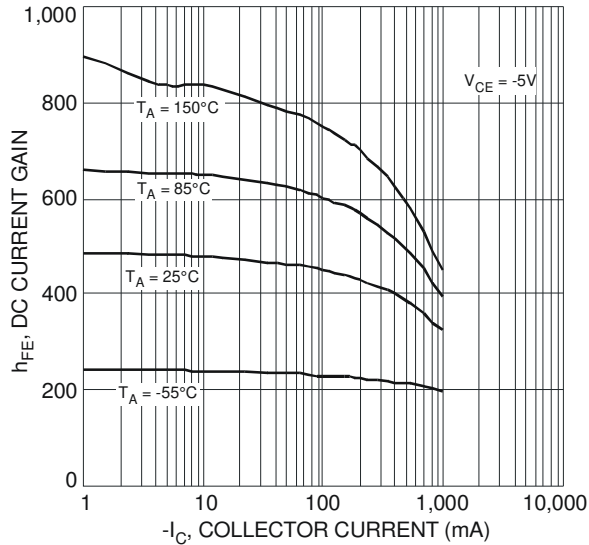


Fig. 3 Typical DC Current Gain vs. Collector Current

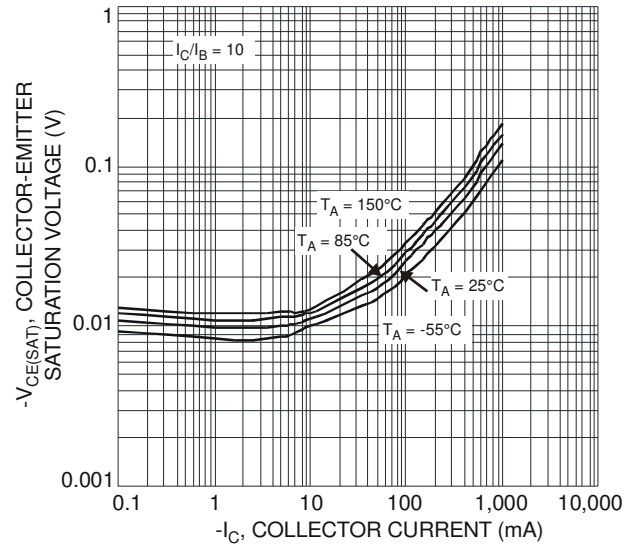


Fig. 4 Typical Collector-Emitter Saturation Voltage vs. Collector Current

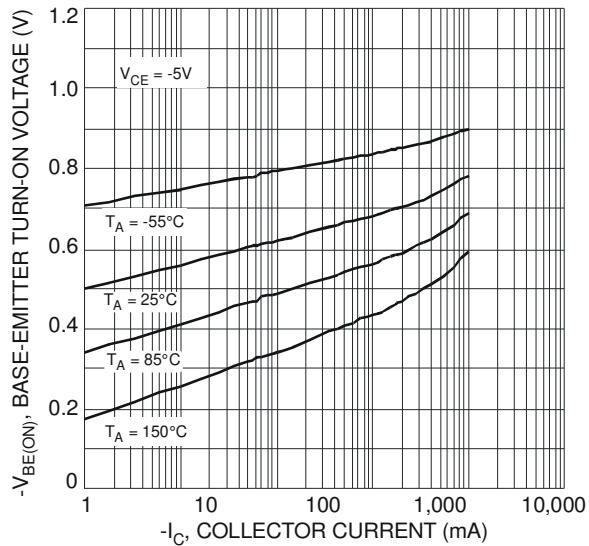


Fig. 5 Typical Base-Emitter Turn-On Voltage vs. Collector Current

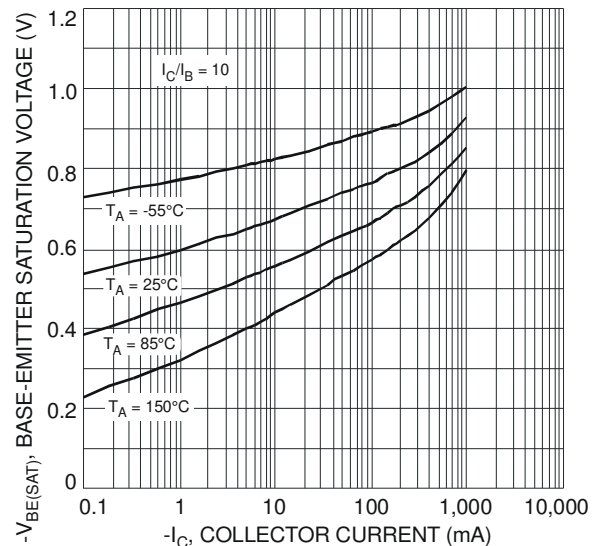


Fig. 6 Typical Base-Emitter Saturation Voltage vs. Collector Current

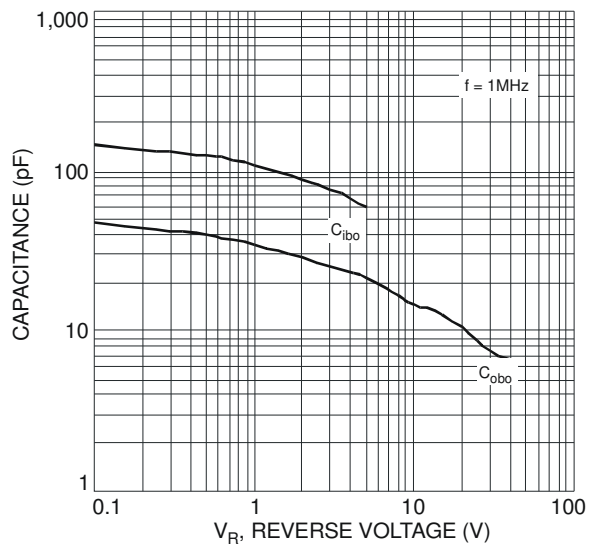


Fig. 7 Typical Capacitance Characteristics

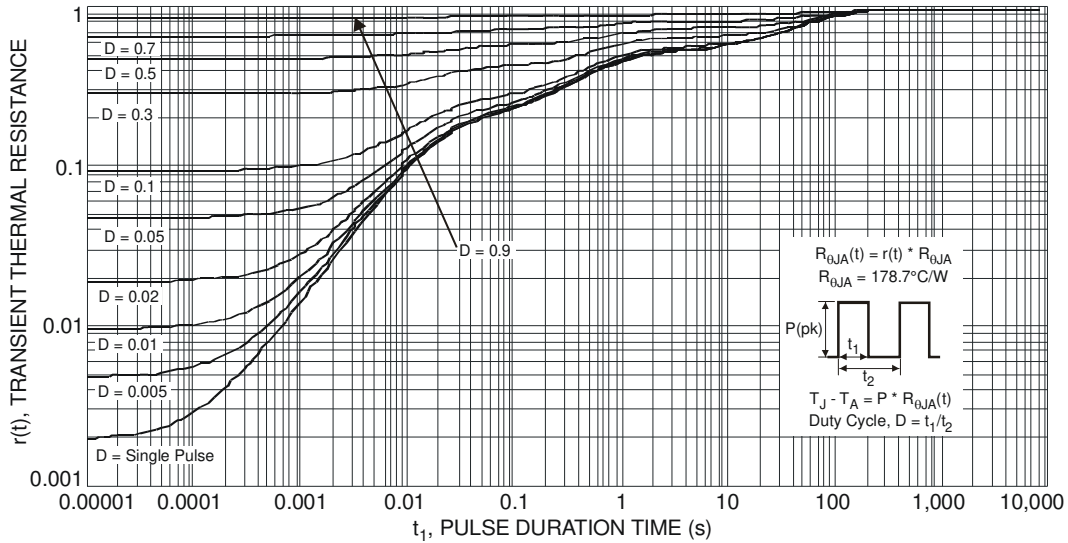


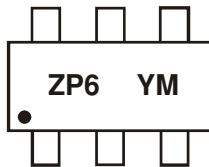
Fig. 8 Transient Thermal Response (Note 3)

**Ordering Information** (Note 5)

Part Number	Case	Packaging
DSS5140V-7	SOT-563	3000/Tape & Reel

Notes: 5. For packaging details, go to our website at <http://www.diodes.com/datasheets/ap02007.pdf>.

**Marking Information**



ZP6 = Product Type Marking Code  
 YM = Date Code Marking  
 Y = Year (ex: V = 2008)  
 M = Month (ex: 9 = September)

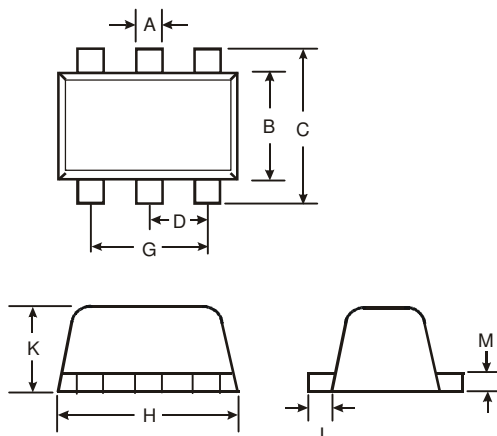
Date Code Key

Year Code	2008	2009	2010	2011	2012	2013	2014	2015
Code	V	W	X	Y	Z	A	B	C

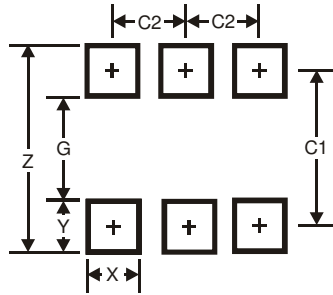
Month Code	Jan	Feb	Mar	Apr	May	Jun	Jul	Aug	Sep	Oct	Nov	Dec
Code	1	2	3	4	5	6	7	8	9	O	N	D

**Package Outline Dimensions**



SOT-563			
Dim	Min	Max	Typ
A	0.15	0.30	0.20
B	1.10	1.25	1.20
C	1.55	1.70	1.60
D	-	-	0.50
G	0.90	1.10	1.00
H	1.50	1.70	1.60
K	0.55	0.60	0.60
L	0.10	0.30	0.20
M	0.10	0.18	0.11
All Dimensions in mm			

**Suggested Pad Layout**



Dimensions	Value (in mm)
<b>Z</b>	2.2
<b>G</b>	1.2
<b>X</b>	0.375
<b>Y</b>	0.5
<b>C1</b>	1.7
<b>C2</b>	0.5

**IMPORTANT NOTICE**

Diodes Incorporated and its subsidiaries reserve the right to make modifications, enhancements, improvements, corrections or other changes without further notice to any product herein. Diodes Incorporated does not assume any liability arising out of the application or use of any product described herein; neither does it convey any license under its patent rights, nor the rights of others. The user of products in such applications shall assume all risks of such use and will agree to hold Diodes Incorporated and all the companies whose products are represented on our website, harmless against all damages.

**LIFE SUPPORT**

Diodes Incorporated products are not authorized for use as critical components in life support devices or systems without the expressed written approval of the President of Diodes Incorporated.

NEW PRODUCT