



Product Name: LTE Terminal Antenna

Part Number: TA-24B-A-L01

Features:

- Support LTE 698-960MHz, 1710-2690MHz
- Connector: 90 Degree SMA Male
- RoHS & REACH Compliant

Applications:

- LTE Router Application
- Smart Metering Application
- IoT Device Application

LTE Terminal Antenna

MODEL: TA-24B-A-L01

Rev.A

I. Specifications:

Items	Specifications					
LTE Electrical Characteristics						
Frequencies (MHz)	698 ~ 824	824 ~ 960	1710 ~ 1880	1850 ~ 1990	1920 ~ 2170	2300 ~ 2690
Efficiency (%)	53.29	50.08	81.72	86.96	79.14	60.48
Average Gain (dBi)	-2.73	-3.00	-0.88	-0.61	-1.02	-2.18
Peak Gain (dBi)	3.85	2.59	4.17	4.31	4.31	3.28
V.S.W.R	< 7.28	< 7.28	< 2.00	< 3.00	< 3.00	< 3.50
Return Loss (dB)	< -2.40	< -2.40	< -10.00	< -6.00	< -6.00	< -5.00
Test Condition	215 x 125 x 15 mm (With Ground Box)					
Impedance (Ω)	50					
Polarization	Linear					
Physical Condition						
Dimensions (mm)	48(L) x 17(W) x 7(T)					
Connector	90° SMA(Male)					
Environmental Conditions						
Operation Temperature (°C)	-40 ~ +85					
Storage Temperature (°C)	-40 ~ +85					
Relative Humidity	95% non-condensing					

© Unictron Technologies Corp.
All specifications subject to change without notice.

II. Antenna Technical Parameters:

S11-parameters (dB)

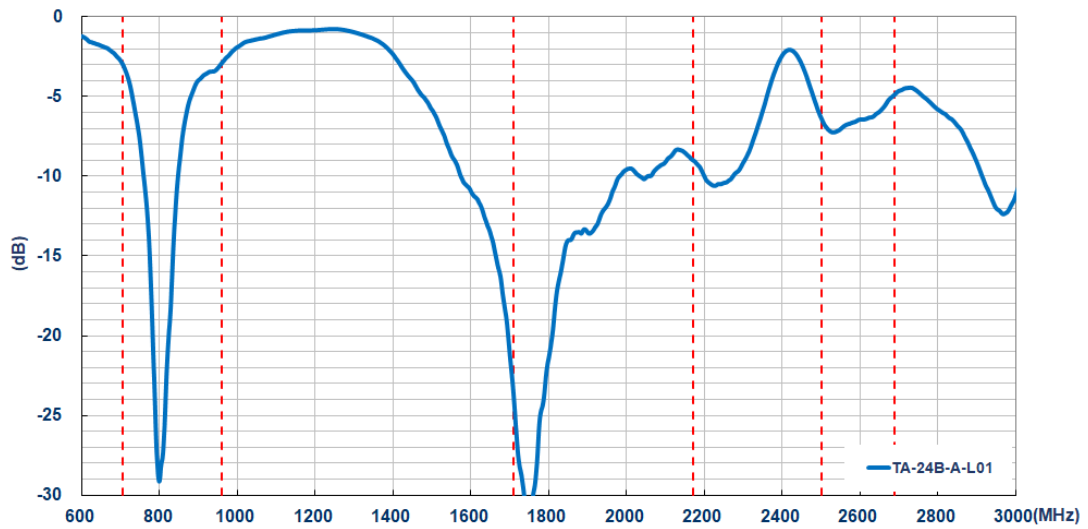

Efficiency (%)

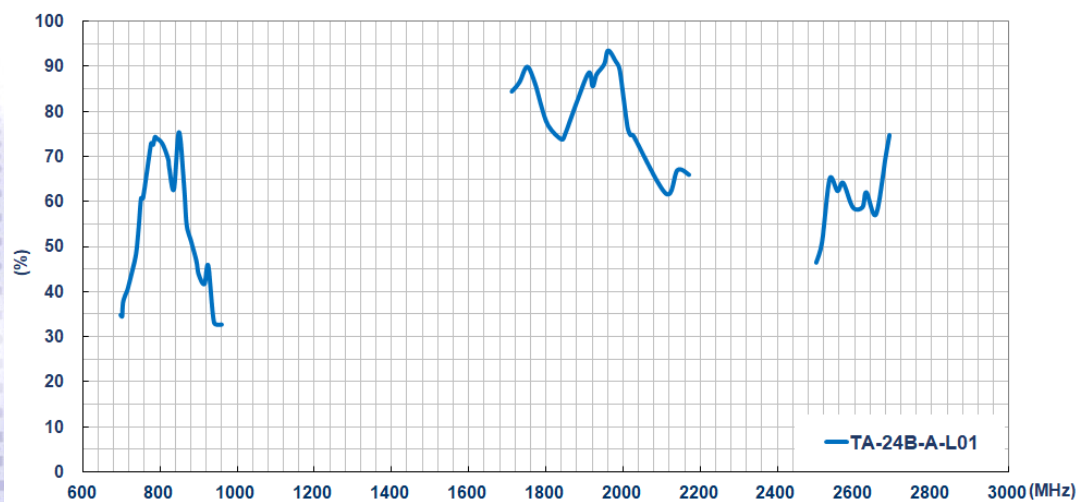

Average Gain (dBi)

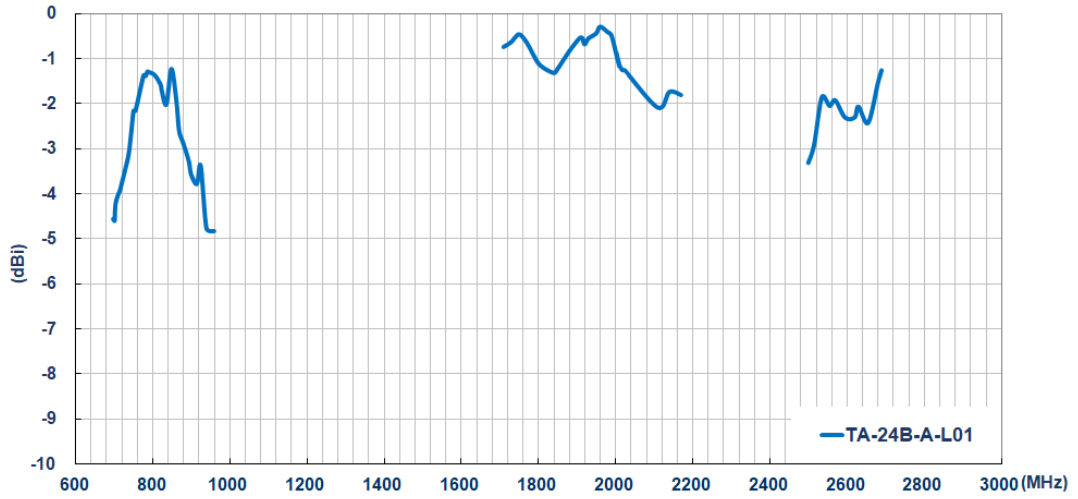

Peak Gain (dBi)

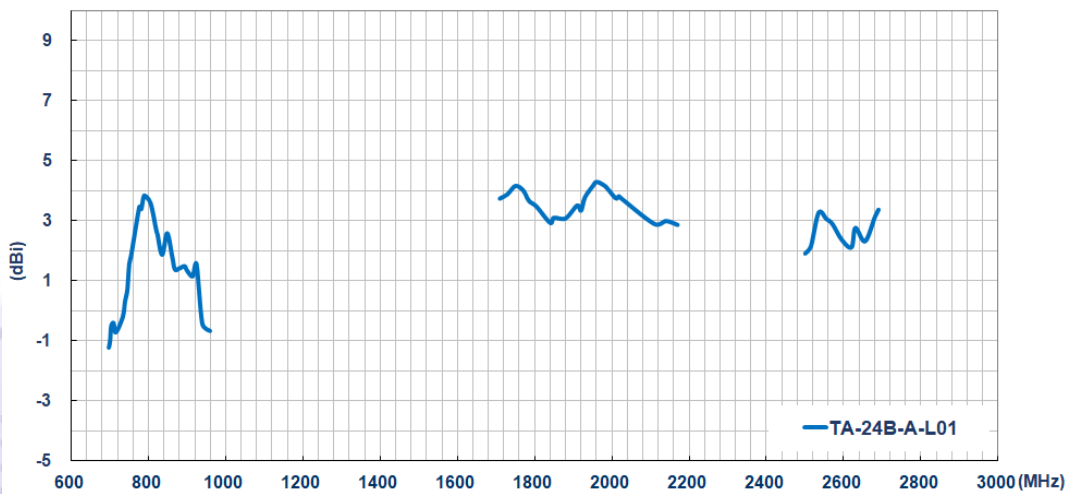

III. Antenna Radiation Pattern Measurement:

The antenna radiation patterns are measured in 3D Anechoic Chamber. The measurement setup is as show below,

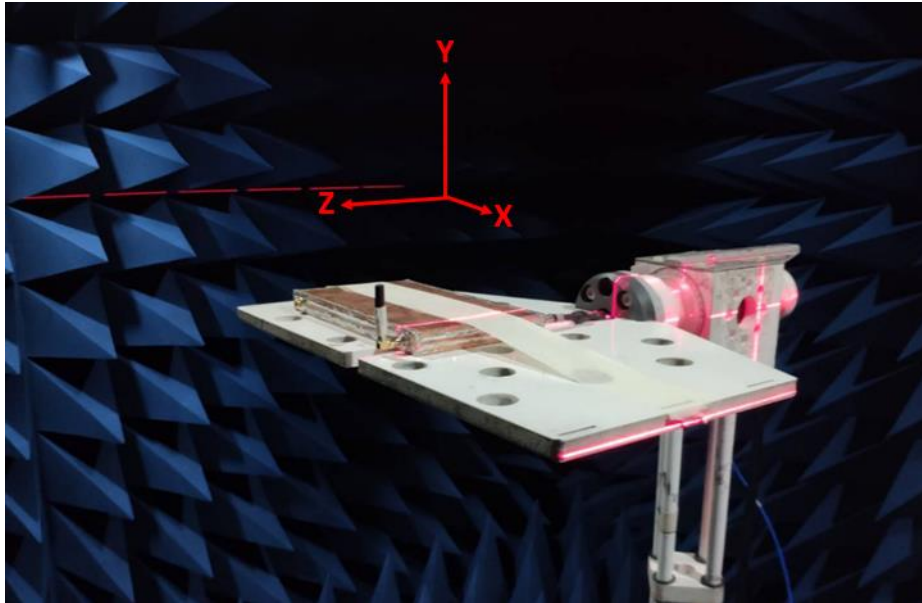

IV. 2D Radiation Pattern:

X-Y plane

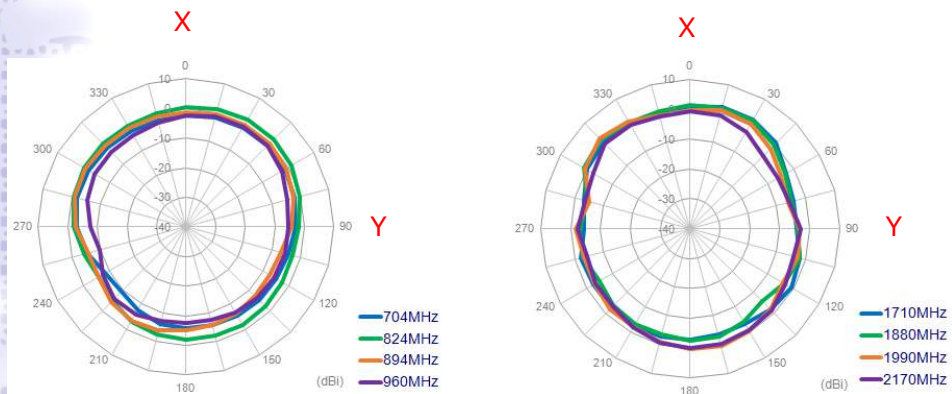

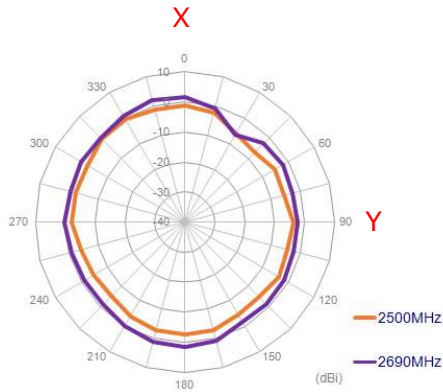

X-Z plane

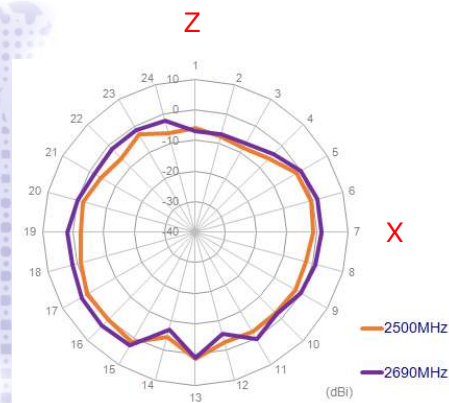
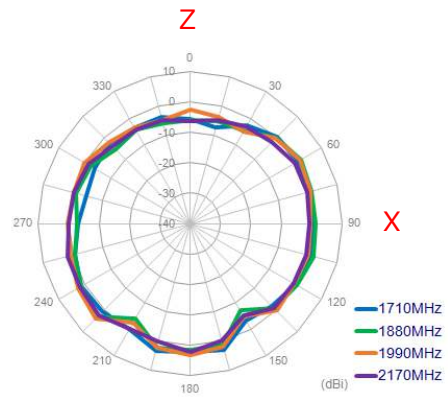
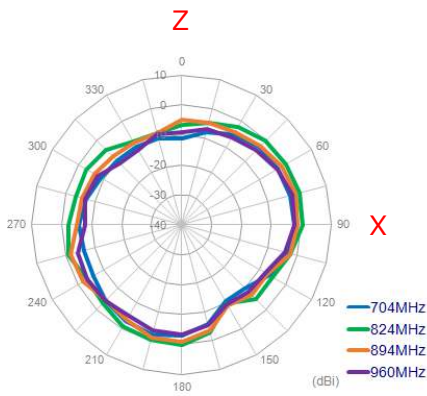

Y-Z plane

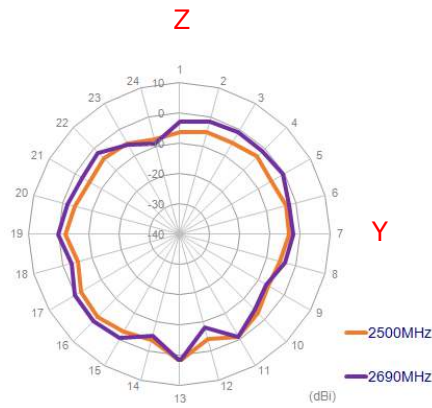
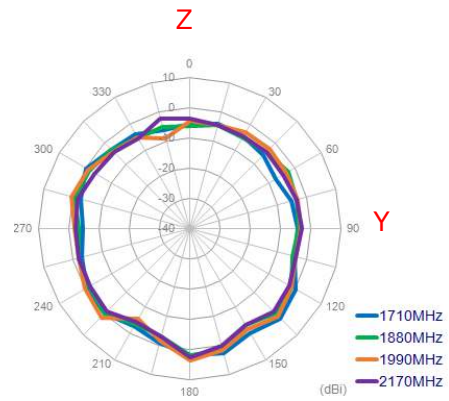
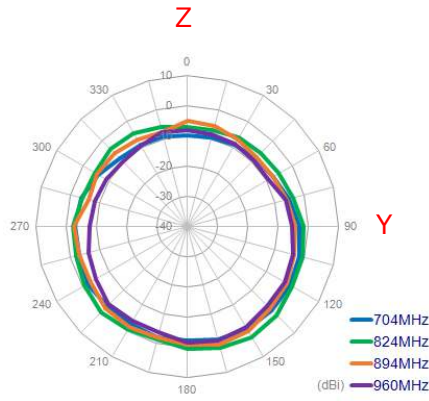

© Unictron Technologies Corp.
All specifications subject to change without notice.

V. 3D Radiation Pattern:

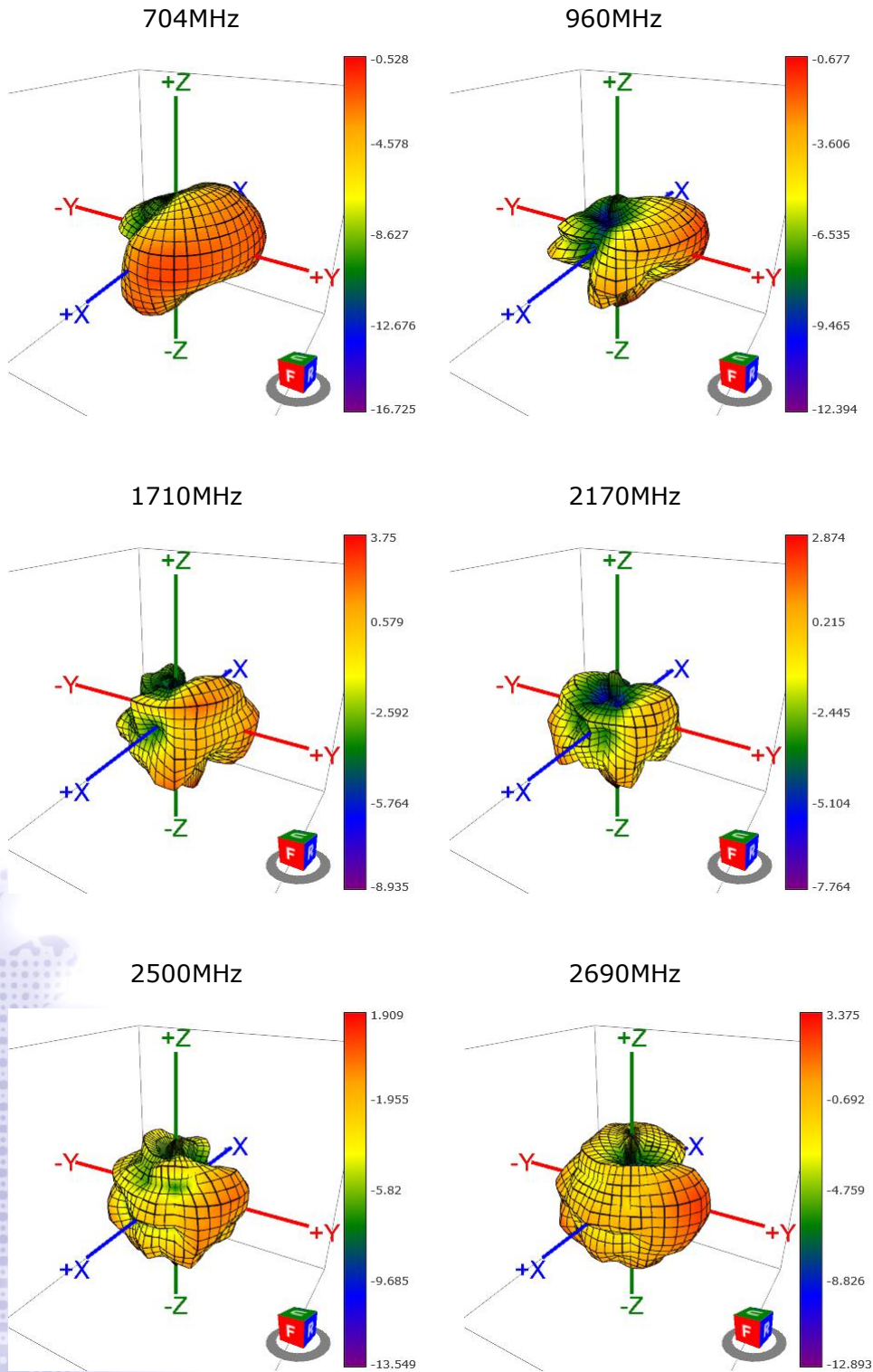

© Unictron Technologies Corp.
All specifications subject to change without notice.

VI. Mechanical Drawing (Unit:mm):

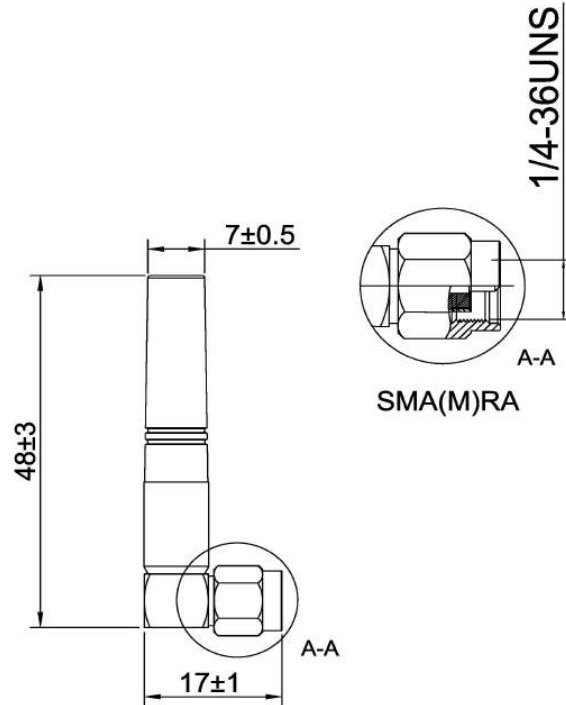

© Unictron Technologies Corp.
All specifications subject to change without notice.