

C&K D Series Miniature Snap-in Power Rocker Switches



Features/Benefits

- **Low cost**
- **Momentary and maintained models**
- **PC and quick connect terminals**
- **Recessed bracket available—prevents accidental actuation**

Typical Applications

- **Computers**
- **Vacuum cleaners**
- **Coffee makers**

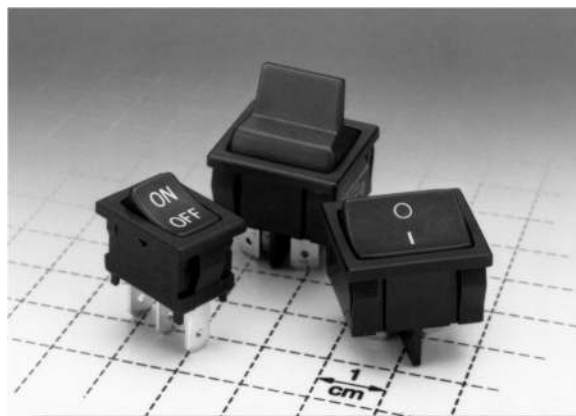

Build-A-Switch

Our easy Build-A-Switch concept allows you to mix and match options to create the switch you need. Below is a complete listing of options shown in catalog. To order, simply select desired option from each category and place in the appropriate box. Switches with standard options are shown on page F-50. Available options are shown and described on pages F-50 thru F-52. For additional options not shown in catalog, consult Customer Service Center.

Typical Example: D 1 0 1 — J 1 — 2 — S 2 — 1 5 — — Q A

Switch Function

- D101 (STD.) SPDT, On-None-On**
- D201 (STD.) DPDT, On-None-On**
- D501 (STD.) SPDT, On-None-On**
- D601 (STD.) DPDT, On-None-On**
- D102 SPST, On-None-Off**
- D103 SPDT, On-Off-On**
- D105 SPDT, Mom.-Off-Mom.**
- D108 SPDT, Mom.-None-On**
- D202 DPST, On-None-Off**
- D203 DPDT, On-Off-On**
- D208 DPDT, Mom.-None-On**
- D502 SPST, On-None-Off**
- D503 SPDT, On-Off-On**
- D508 SPDT, Mom.-None-On**
- D602 DPST, On-None-Off**
- D603 DPDT, On-Off-On**
- D608 DPDT, Mom.-None-On**

Actuator

- J1 (STD.) Rocker**
- J5 Lever**

Actuator Color

- 2 (STD.) Black**
- 1 White**
- 3 Red**
- T Beige**

Mounting Style/Color

- S2 (STD.) Snap-in, black**
- B2 Recessed snap-in bracket, black**
- S1 Snap-in, white**
- S3 Snap-in, red**
- ST Snap-in, beige**

Terminations

- 15 (STD.) Quick connect**
- A Right angle, PC thru-hole**
- 02 PC Thru-hole**
- 05 Twisted quick connect**
- 06 Extended PC thru-hole**
- 17 Wirable quick connect**

Actuator Markings

- NONE (STD.) No marking**
- D ON-OFF**
- H 0 I**
- N Large dot**
- P 0 -**
- R Red rectangle on end**
- U Large dot on end**

Contact Material

- QA (STD.) Silver (UL/CSA)**
- QF (STD.) Silver (UL/CSA/VDE)**

Specifications

CONTACT RATING: D10X and D20X Models: 4 AMPS @ 125 V AC; 2 AMPS @ 250 V AC. D50X and D60X Models: 10 AMPS @ 125 V AC; 5 AMPS @ 250 V AC.

ELECTRICAL LIFE: 10,000 make-and-break cycles at full load.

INSULATION RESISTANCE: 10⁹ ohms min.

DIELECTRIC STRENGTH: 1,000 V RMS min. @ sea level.

NOTE: Specifications and materials listed above are for standard switches. For information on specific and custom switches, consult Customer Service Center.

Materials

ACTUATOR & HOUSING: 6/6 nylon (UL 94V-2), color black, standard; finish: matte.

MOVABLE CONTACTS: D10X and D20X Models: Copper, silver plated. D50X and D60X Models: Coin silver, silver plated.

STATIONARY CONTACTS AND TERMINALS: Copper or brass, silver plated.

CONTACT SPRING: Music wire or stainless steel.

C&K D Series Miniature Snap-in Power Rocker Switches

SWITCHES WITH STANDARD OPTIONS



D102J12S215QA
SPDT

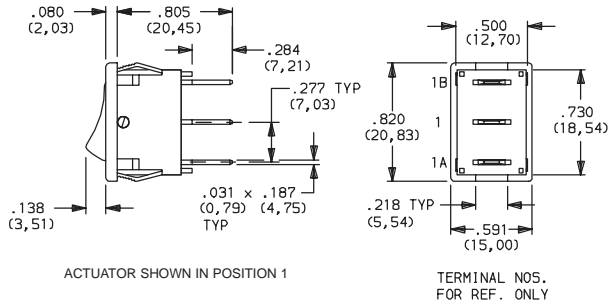

PART NUMBER	FUNCTION	POS. 1	POS. 2	POS. 3
D102J12S215QA	SPDT	ON	NONE	OFF
D501J12S215QA	SPDT	ON	NONE	ON
D502J12S215QA	SPST	ON	NONE	OFF

NOTE: For panel mounting information, see page F-51.



D201J12S215QA
DPDT

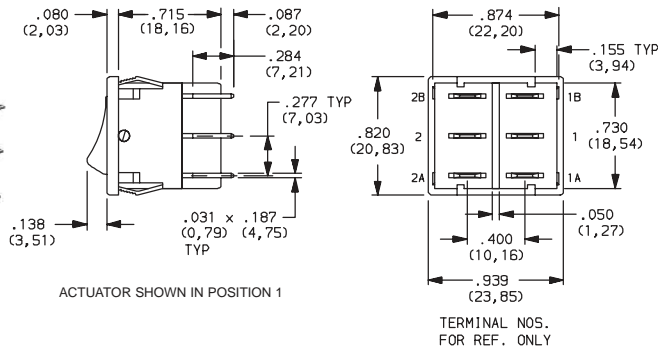

PART NUMBER	FUNCTION	POS. 1	POS. 2	POS. 3
D201J12S215QA	DPDT	ON	NONE	ON
D602J12S215QA	DPST	ON	NONE	OFF

NOTE: For panel mounting information, see page F-51.



D501J12S2AQA
Horizontal Actuation
SPDT

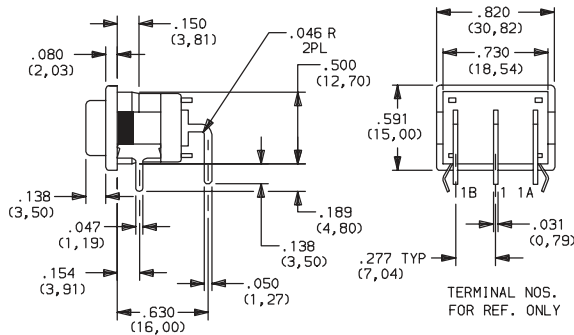

PART NUMBER	FUNCTION	POS. 1	POS. 2	POS. 3
D501J12S2AQA	SPDT	ON	NONE	ON

NOTE: For PC mounting information, see page F-52.

SWITCH FUNCTION

NO. POLES	MODEL NO.	AMP RATING*	SWITCH FUNCTION			CONNECTED TERMINALS			SCHEMATIC
			POS. 1	POS. 2	POS. 3	POS. 1	POS. 2	POS. 3	
SP	D102 D502	4 10	ON	NONE	OFF	1-1A	OPEN	OPEN	 SPDT
	D101 (STD.) D501 (STD.)	4 10	ON	NONE	ON	1-1A	OPEN	1-1B	
	D103 D503	4 10		OFF					
	D105	4	MOM.	OFF	MOM.				
	D108 D508	4 10	MOM.	NONE	ON				

MOM. = MOMENTARY

*AMP RATING: D10X and D20X models: 4 AMPS @ 125 V AC; 2 AMPS @ 250 V AC. D50X and D60X models: 10 AMPS @ 125 V AC; 5 AMPS @ 250 V AC.

All models . DX01, DX02 models also available with . See CONTACT MATERIALS, page F-52.

C&K D Series Miniature Snap-in Power Rocker Switches

SWITCH FUNCTION

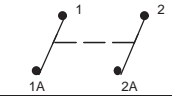
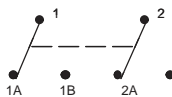
NO. POLES	MODEL NO.	AMP RATING*	SWITCH FUNCTION			CONNECTED TERMINALS			SCHEMATIC
			POS. 1	POS. 2	POS. 3	POS. 1	POS. 2	POS. 3	
DP	D202 D602	4 10	ON	NONE	OFF	1-1A, 2-2A	OPEN	OPEN	
	D201 (STD.) D601 (STD.)	4 10	ON	NONE	ON	1-1A, 2-2A	OPEN	1-1B, 2-2B	
	D203 D603	4 10		OFF					
	D208 D608	4 10	MOM.	NONE					

MOM. = MOMENTARY

*AMP RATING: D10X and D20X models: 4 AMPS @ 125 V AC; 2 AMPS @ 250 V AC. D50X and D60X models: 10 AMPS @ 125 V AC; 5 AMPS @ 250 V AC.

All models . DX01, DX02 models also available with . See CONTACT MATERIALS, page F-52.

ACTUATOR

J1 (STD.) ROCKER

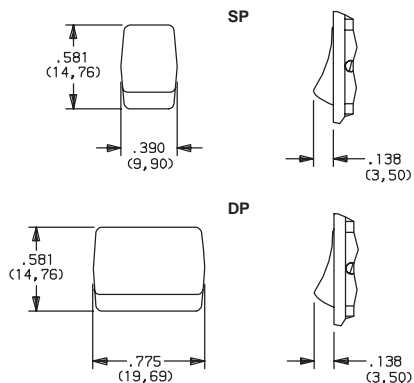

J5 LEVER

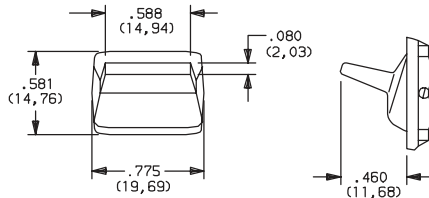

'J5' actuator available only with DP models D201, D202, D601 and D602.

OPTION CODE	ACTUATOR COLOR
2	(STD.) BLACK
1	WHITE
3	RED
T	BEIGE

NOTE: Actuator finish: matte. Other colors available, consult Customer Service Center.

MOUNTING STYLE/COLOR

S (STD.) SNAP-IN

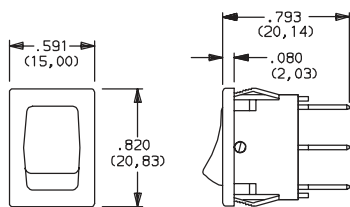

OPTION CODE	HOUSING COLOR
2	(STD.) BLACK
1	WHITE
3	RED
T	BEIGE

NOTE: Frame finish on housing: matte. Other colors available, consult Customer Service Center.

B RECESSED SNAP-IN BRACKET

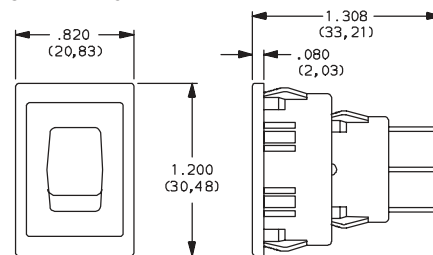

NOTE: Available in black, vertical mount, SP models only.

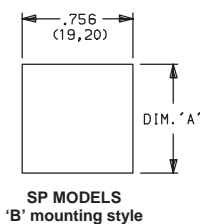
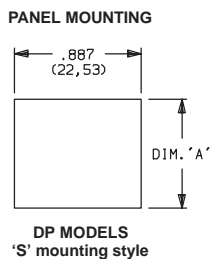
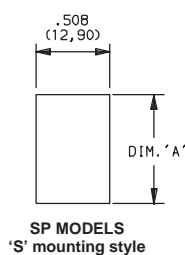

PANEL THK.	DIM. 'A' SP & DP MODELS 'S' MOUNTING STYLE	DIM. 'A' SP MODELS 'B' MOUNTING STYLE
.030-.049 (0,75) (1,25)	.756 (19,20)	1.068 (27,13)
.049-.079 (1,25) (2,00)	.764 (19,40)	1.076 (27,33)
.079-.118 (2,00) (3,00)	.780 (19,80)	1.092 (27,74)



C&K D Series Miniature Snap-in Power Rocker Switches

TERMINATIONS

A RIGHT ANGLE, PC THRU-HOLE

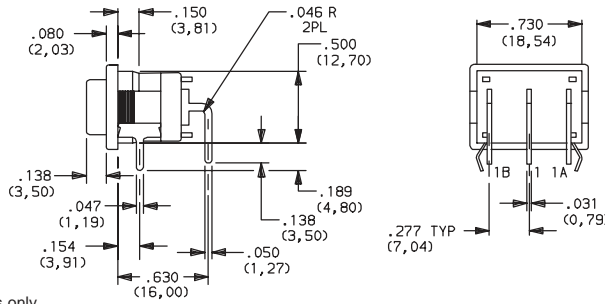
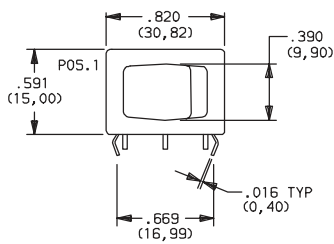

PC MOUNTING

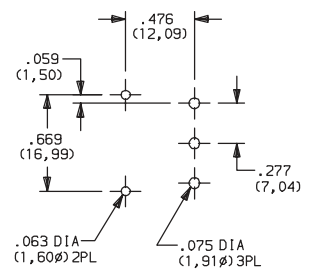

Available with D101, D102, D501, D502 SP models only.

02 PC THRU-HOLE

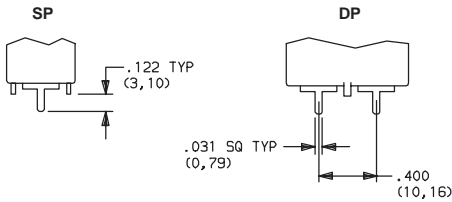

Available with DX01 and DX02 models only.

06 EXTENDED PC THRU-HOLE

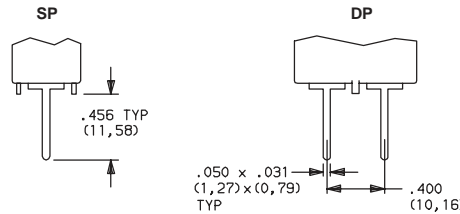

Available with DX01 and DX02 models only.

PC MOUNTING (02 and 06)

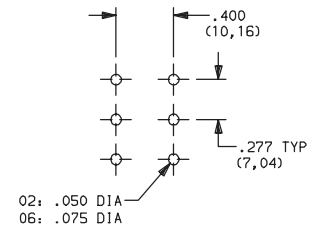

15 (STD.) QUICK CONNECT

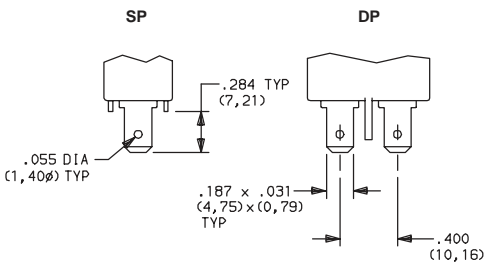

Available with DX01 and DX02 models only.

05 TWISTED QUICK CONNECT

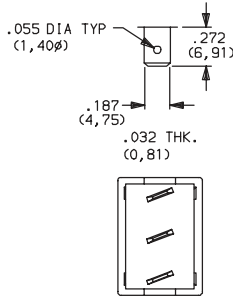

NOTE: Terminals are twisted. Available with DX03, DX05 and DX08 models only.

17 WIRABLE QUICK CONNECT

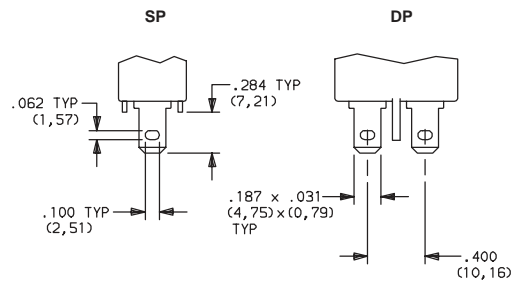

Available with DX01 and DX02 models only.

ACTUATOR MARKINGS

NONE (STD.) NO MARKING **D** ON-OFF **H** O I **N** LARGE DOT **P** O- **R** RED RECTANGLE ON END **U** LARGE DOT ON END

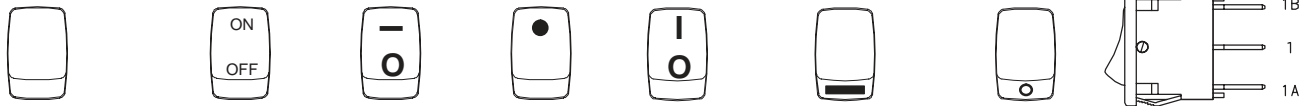

'D, H, P & U' marking options: marking color white, standard for all actuator colors except white. Black marking color, standard for white actuators. 'R & N' marking option: red marking color, standard. consult Customer Service Center for other available marking colors.

NOTE: Orientation of actuator markings and terminals.

CONTACT MATERIAL

OPTION CODE	CONTACT AND TERMINAL MATERIAL	RATINGS
QA (STD.)	SILVER ¹	D10X and D20X MODELS: 4 AMPS @ 125 V AC; 2 AMPS @ 250 V AC (UL/CSA). D50X and D60X MODELS: 10 AMPS @ 125 V AC; 5 AMPS @ 250 V AC (UL/CSA).
QF (STD.)		D10X and D20X MODELS: 4 AMPS @ 125 V AC; 2 AMPS @ 250 V AC (UL/CSA). 4(2) AMPS @ 125 V AC; 2(1) AMPS @ 250 V AC, T85 (VDE). 2(1) AMPS @ 250 V AC. D50X and D60X MODELS: 10 AMPS @ 125 V AC; 5 AMPS @ 250 V AC (UL/CSA). 10(6) AMPS @ 125 V AC; 5(3) AMPS @ 250 V AC, T85 (VDE). 5(3) AMPS @ 250 V AC.

¹MOVABLE CONTACT: D10X and D20X MODELS: Copper, silver plated.
D50X and D60X MODELS: Coin silver, silver plated.
STATIONARY CONTACTS & TERMINALS: Copper or brass, silver plated.

All models with all options. DX01, DX02 models when ordered with 'QF' contact material.