

## Processor Module and Device Adapter Specification

### CONTENTS

1.0 Introduction .....	1
2.0 MPLAB ICE 4000 System.....	1
3.0 Emulator-Related Issues .....	2
4.0 Processor Modules .....	2
5.0 Device Adapters .....	4
6.0 Device Adapter Target Footprints .....	5

### 1.0 INTRODUCTION

The components of an MPLAB<sup>®</sup> ICE 4000 in-circuit emulator system are shown in Figure 2-1. Processor modules and device adapters are an important part of this system.

Processor modules allow emulation of different PICmicro<sup>®</sup> microcontrollers (MCUs) and dsPIC<sup>®</sup> digital signal controllers (DSCs).

Device adapters are interchangeable assemblies that allow the emulator to interface to a target application system. Device adapters also have control logic that allows the target application to provide a clock source and power to the processor module.

### 2.0 MPLAB ICE 4000 SYSTEM

The different components of the emulator system are shown in the Figure 2-1. Each component is discussed in the following subsections.

#### 2.1 Host-to-Pod Cable

The MPLAB ICE 4000 emulator pod may be connected to a host PC by USB cable.

The USB cable is a standard USB cable, compliant to version 1.1 of the USB specification.

#### 2.2 Emulator Pod

The emulator pod contains emulator memory and control logic. There are no field serviceable parts in the pod. For more information on the pod, see the MPLAB ICE 4000 on-line help file in MPLAB IDE (*Help>Topics*) or the *MPLAB<sup>®</sup> ICE 4000 User's Guide* (DS51490).

A MPLAB ICE 4000 processor module must be inserted into the pod for operation.

#### 2.3 Processor Module

The processor module contains the emulator chip, logic and low-voltage circuitry. There are no field serviceable parts mounted on the printed circuit board housed within the processor module enclosure.

**FIGURE 2-1: MPLAB ICE 4000 EMULATOR SYSTEM**

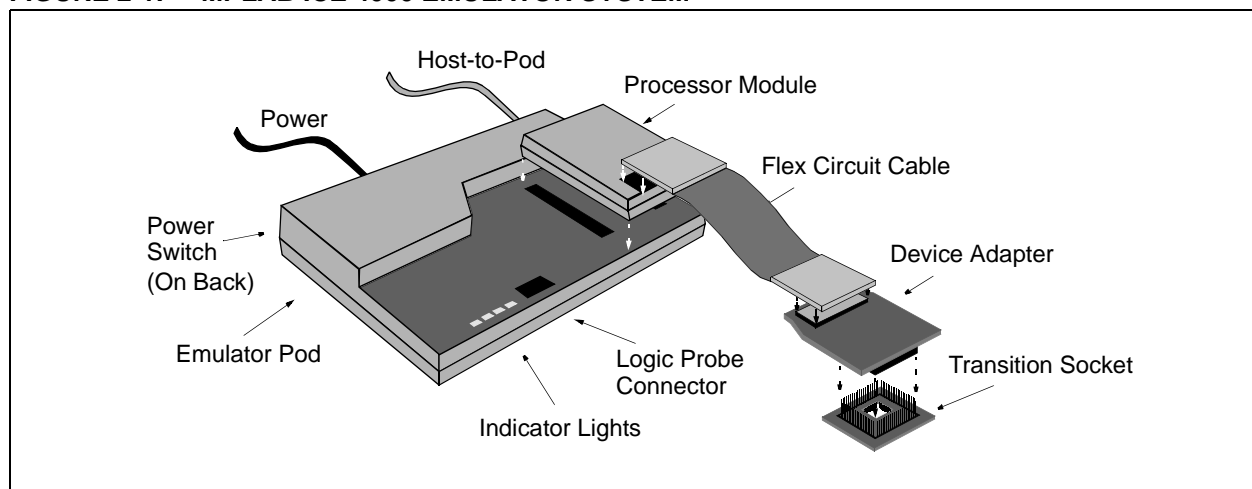

## 2.4 Flex Circuit Cable

Once the processor module is inserted into the emulator pod, the flex circuit cable extends the emulator system to the target application.

Emulator analog functions may not operate within the performance specifications published in the device data sheet due to parasitic capacitance (up to 120 pF) of the flex cable.

## 2.5 Device Adapter

The device adapter provides a common interface for the device being emulated. It is provided in standard DIP and transition socket styles for other packages. The adapter also contains a special device that provides an oscillator clock to accurately emulate the oscillator characteristics of the PICmicro MCU.

Due to components on the device adapter, which require target power, the device adapter should be removed from the flex circuit cable (see Figure 2-1) when emulator power is being used and the processor module is not connected to the target. This will eliminate any loading effects on I/O pins.

## 2.6 Transition Socket

Transition sockets are available in various styles to allow a common device adapter to be connected to one of the supported surface mount package styles. Transition sockets are available for various pin counts and pitches for PLCC, SOIC, QFP, QFN and other styles. For more information on transition sockets, see the *MPLAB ICE 2000/4000 Transition Socket Specification* (DS51194).

## 3.0 EMULATOR-RELATED ISSUES

General limitations that apply to the MPLAB ICE 4000 emulator may be found in the on-line help. Select [Help>Topics](#) and then select "MPLAB ICE 4000" under "Debuggers".

Device-specific limitations can be found as above or by selecting [Debugger>Settings](#), clicking the **Limitations** tab, and then clicking the **Details** button.

## 4.0 PROCESSOR MODULES

Processor modules are identified on the top of the assembly (e.g., PMF18WA0). To determine which processors are supported by a specific module, refer to the file "Readme for MPLAB ICE 4000.txt" in the MPLAB IDE installation directory or the latest *Product Selector Guide* (DS00148), which can be found on the Microchip web site at [www.microchip.com](http://www.microchip.com).

A typical processor module contains a special bond-out version of a PICmicro MCU or dsPIC DSC, device buffers to control data flow and control logic. It provides the means of configuring the MPLAB ICE 4000 emulator for a specific device family and handles low-voltage emulation when needed.

### 4.1 Power

The operating voltage for most of the control logic and buffering on the processor module is supplied by the emulator pod. Power to the emulator processor and some of its surrounding buffers is user-selectable, and can be powered by the emulator pod (at +5V only) or the target application system (from 2.0V to 5.5V). This is software selectable and is configurable through the MPLAB IDE software. At no time will the emulator system directly power the target application system. ALWAYS insert the processor module into the emulator pod before applying power to the pod.

When connecting to a target application system, there may be a voltage level on the target application even though power has not yet been applied to the target application circuit. This is normal, and is due to current leakage through VCC of the device adapter. The current leakage will typically be less than 20 mA. However, if the target application is using a voltage regulator, it should be noted that some regulators require the use of an external shunt diode between VIN and VOUT for reverse-bias protection. Refer to the manufacturer's data sheets for additional information.

#### 4.1.1 EMULATOR PROCESSOR POWER SUPPLIED BY EMULATOR SYSTEM

If the emulator system is selected to power the emulator processor in the processor module, the emulator system can be operated without being connected to a target application. If the system is being connected to a target application, the power to the pod should be applied before applying power to the target application.

The target application system's VCC will experience a small current load (10 mA typical) when the emulator system is connected via a device adapter. This is because the target system must always power the clock chip in the device adapter.

# Processor Module and Device Adapter Specification

---

## 4.1.2 EMULATOR PROCESSOR POWER SUPPLIED BY TARGET APPLICATION SYSTEM

When the MPLAB IDE software is brought up, the emulator system is first initialized with the emulator system powering the emulator processor. The “Processor Power Supplied by Target Board” option may then be selected using the **Power** tab of the Settings dialog (*Debugger>Settings*) to power the processor module from the target board.

When operating from external power, the processor module will typically represent a current load equivalent to the device being emulated (according to its data sheet) plus approximately 100 mA. Keep in mind that the target application will affect the overall current load of the processor module, dependent upon the load placed upon the processor I/O.

When the processor power is supplied by the target application system, an external clock (from the target board) may also be provided. MPLAB IDE will not allow use of an external clock without the use of external power.

## 4.1.3 OPERATING VOLTAGE OF 4.6 TO 5.5 VOLTS

If the target application system's operating voltage is between 4.55V ( $\pm 120$  mV) and 5.5V, the processor module will consider this a STANDARD VOLTAGE condition. In this mode, the processor can run to its highest rated speed (as indicated in its data sheet).

The recommended power-up sequence is:

1. Apply power to the PC host.
2. Apply power to the emulator pod and processor module assembly.
3. Invoke MPLAB IDE.
4. Select *Debugger > Settings* and click the **Power** tab. Configure system for “Processor Power Supplied by Target Board”.
5. At the error message, apply power to the target application circuit. Then acknowledge the error.
6. Issue a System Reset (from the debugger menu) before proceeding.

## 4.1.4 OPERATING VOLTAGE OF 2.0 TO 4.6 VOLTS

If the target application system's operating voltage is between 2.0V and 4.55V ( $\pm 120$  mV), the processor module will consider this a LOW VOLTAGE condition. In this mode, the processor is limited to its rated speed at a given voltage level (as indicated in its data sheet).

To minimize the amount of reverse current that the target system is exposed to, the recommended power-up sequence is:

1. Apply power to the PC host.
2. Apply power to the emulator pod and processor module assembly.
3. Invoke MPLAB IDE.
4. Select *Debugger > Settings* and click the **Power** tab. Configure system for “Processor Power Supplied by Target Board”.
5. At the error message, apply power to the target application circuit. Then acknowledge the error.
6. Issue a System Reset (from the debugger menu) before proceeding.
7. Select *Debugger > Settings* and click the **Power** tab. Verify that the dialog says “Low Voltage Enabled.” Click **Cancel** to close the dialog.

## 4.2 Operating Frequency

The processor modules will support the maximum frequency of the device under emulation. The maximum frequency of a PICmicro MCU device is significantly lower when the operating voltage is less than 4.5V.

The processor modules will support a minimum frequency of 32 kHz. When operating at low frequencies, response to the screen may be slow.

## 4.3 Clock Options

MPLAB ICE 4000 allows internal and external clocking. When set to internal, the clock is supplied from the internal programmable clock, located in the emulator pod. When set to external, the oscillator on the target application system will be utilized.

### 4.3.1 CLOCK SOURCE FROM EMULATOR

Refer to the MPLAB ICE 4000 on-line help file in MPLAB IDE (*Help>Topics*) or the *MPLAB<sup>®</sup> ICE 4000 User's Guide* (DS51490), “Using the On-Board Clock”, for configuring MPLAB IDE to supply the clock source.

## 4.3.2 CLOCK SOURCE FROM THE TARGET APPLICATION

If the target application is selected to provide the clock source, the target board must also be selected to power the emulator processor (see the MPLAB ICE 4000 on-line help file in MPLAB IDE (*Help>Topics*) or the *MPLAB® ICE 4000 User's Guide* (DS51490), "Using a Target Board Clock").

At low voltage, the maximum speed of the processor will be limited to the rated speed of the device under emulation.

An oscillator circuit on the device adapter generates a clock to the processor module and buffers the clock circuit on the target board. In this way, the MPLAB ICE 4000 emulator closely matches the oscillator options of the actual device. All oscillator modes are supported (as documented in the device's data sheet) except as noted in **Section 3.0 "Emulator-Related Issues"**. The OSC1 and OSC2 inputs of the device adapter have a 5 pF to 10 pF load. Be aware of this when using a crystal in HS, XT, LP or LF modes, or an RC network in RC mode.

The frequency of the emulated RC network may vary relative to the actual device due to emulator circuitry. If a specific frequency is important, adjust the RC values to achieve the desired frequency. Another alternative would be to allow the emulator to provide the clock as described in **Section 4.3.1 "Clock Source from Emulator"**.

When using the target board clock, the system's operating voltage is between 2.5V and 5.5V.

## 4.4 ESD Protection and Electrical Overstress

All CMOS chips are susceptible to electrostatic discharge (ESD). In the case of the processor modules, the pins of the CMOS emulator are directly connected to the target connector, making the chip vulnerable to ESD. ESD can also induce latch-up in CMOS chips, causing excessive current through the chip and possible damage. MPLAB ICE 4000 has been designed to minimize potential damage by implementing overcurrent protection. However, care should be given to minimizing ESD conditions while using the system.

During development, contention on an I/O pin is possible (e.g., when an emulator pin is driving a '1' and the target board is driving a '0'). Prolonged contention may cause latch-up and damage to the emulator chip. One possible precaution is to use current limiting resistors (~100 Ω) during the development phase on bidirectional I/O pins. Using limiting resistors can also help avoid damage to modules, device adapters and pods that occurs when a voltage source is accidentally connected to an I/O pin on the target board.

## 4.5 Freeze Mode

The MPLAB ICE 4000 system allows the option of "freezing" peripheral operation or allowing them to continue operating when the processor is halted. This option is configured in the MPLAB IDE.

This function is useful to halt an on-board timer while at a break point. At a break point, and while single stepping, interrupts are disabled.

## 5.0 DEVICE ADAPTERS

The MPLAB ICE 4000 device adapters use a serial EEPROM that is interrogated by MPLAB IDE to determine what device adapter type and revision is connected. Using this information, along with the selected device, MPLAB IDE will determine the device adapter configuration (i.e., there are no switches or jumpers to be configured on the device adapters).

Two test points are provided for the use: GND (black) and VCCME (red).

When target is selected, the "target power" LED will illuminate on certain adapters to visually indicate Target Power mode.

Device adapters are specified as DAFX-N, where XX denotes the device family (e.g., 18, 30) and N denotes a number. See the file "Readme for MPLAB ICE 4000.txt" in the MPLAB IDE installation directory for a list of current device adapters and the devices they support.

Please see the *MPLAB® ICE 2000/4000 Transition Socket Specification* (DS51194) for transition sockets that are used with these device adapters.

# Processor Module and Device Adapter Specification

## 6.0 DEVICE ADAPTER TARGET FOOTPRINTS

To connect an emulator device adapter directly to a target board (without the use of transition sockets) the following information will be helpful.

### 6.1 DIP Device Footprints

DIP device adapter footprints shown will accept adapter plugs like Samtec series APA plugs. These plugs can be soldered in place during development/emulation and eliminate the need for any other sockets.

**FIGURE 6-1: DAF DRAWING – DIP**

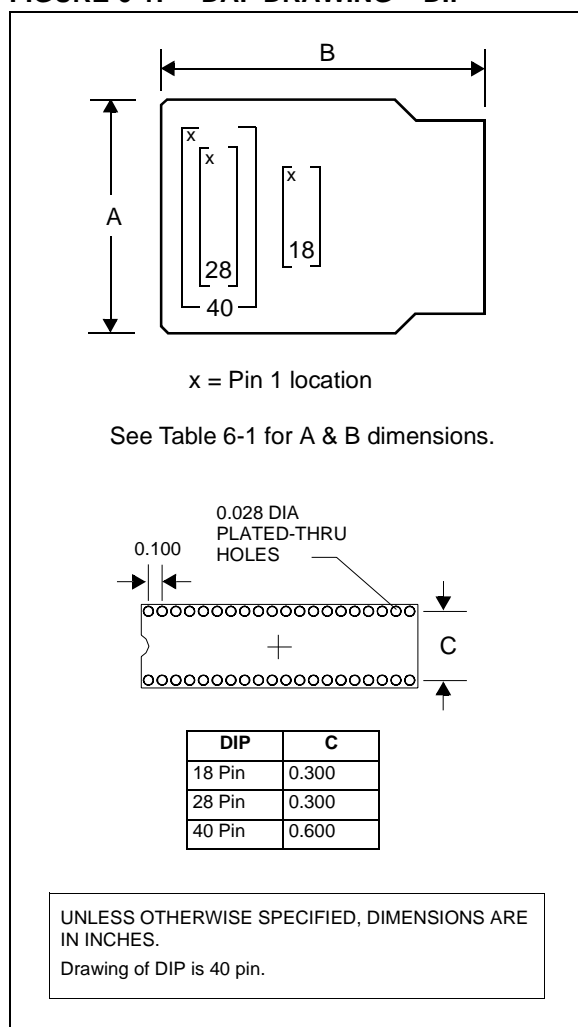

**TABLE 6-1: DAF DIMENSIONS – DIP**

Package	DAF Number*	A	B
18/28/40P DIP	DAF18-2	2.600	2.950
18/28/40P DIP	DAF18-4	2.600	3.100
18/28/40P DIP	DAF30-4	2.600	3.300

\* See the MPLAB ICE 4000 Readme file for information on devices supported by each DAF.

### 6.2 TQFP/PLCC Device Footprints

TQFP/PLCC device adapter footprints shown will accept board stackers like Samtec series DWM 0.050 Pitch Stackers. These stackers can be soldered in place during development/emulation and eliminate the need for any other sockets.

**FIGURE 6-2: DAF DRAWING – SINGLE-ROW TQFP/PLCC**

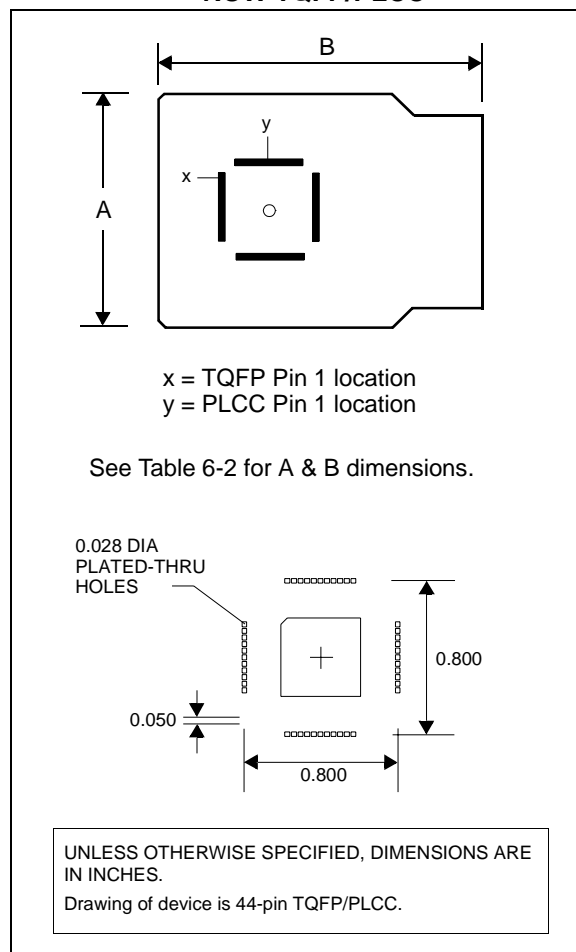
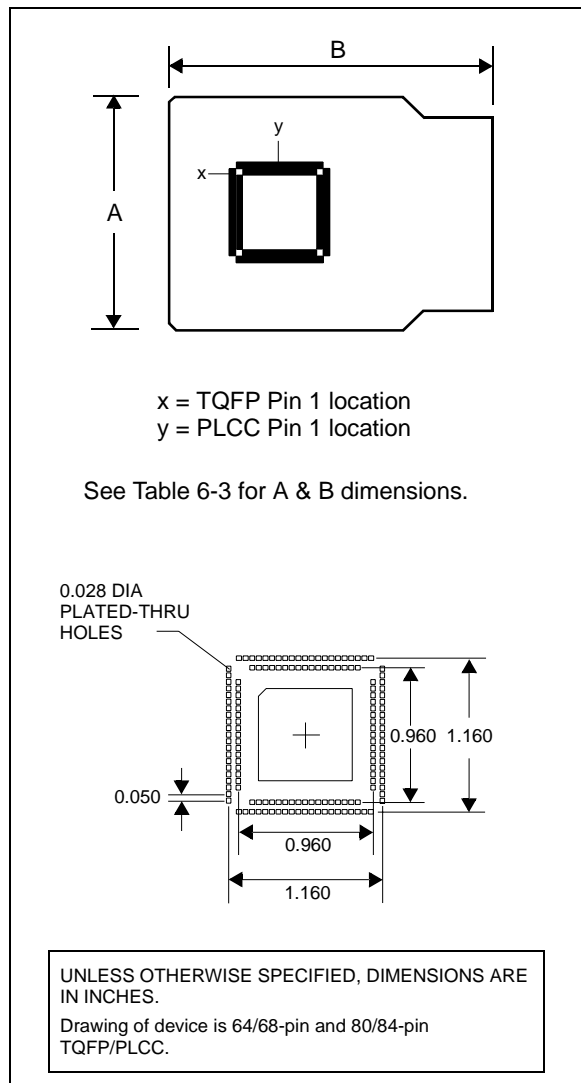

**TABLE 6-2: DAF DIMENSIONS – TQFP/PLCC**

Package	DAF Number*	A	B
44P TQFP/PLCC	DAF18-3	2.600	2.950
44P TQFP/PLCC	DAF18-5	2.600	3.100
44P TQFP/PLCC	DAF30-3	2.600	2.950

\* See the MPLAB ICE 4000 Readme file for information on devices supported by each DAF.

**FIGURE 6-3: DAF DRAWING – DOUBLE-ROW TQFP/PLCC**



Device adapter pin-out matches the PLCC package. PLCC will map to TQFP as follows:

- DVA-44PL interface to 44-pin TQFP – one-to-one mapping.
- DVA-68PL interface to 64-pin TQFP – see Figure 6-4 for mapping.
- DVA-84PL interface to 80-pin TQFP – see Figure 6-5 for mapping.

**TABLE 6-3: DAF DIMENSIONS – TQFP/PLCC**

Package	DAF Number*	A	B
64/80 TQFP 68/84 PLCC	DAF18-6	2.600	3.100
64/80 TQFP 68/84 PLCC	DAF18-1	2.600	2.950
64/80 TQFP 68/84 PLCC	DAF30-2	2.600	2.950

\* See the MPLAB ICE 4000 Readme file for information on devices supported by each DAF.

# Processor Module and Device Adapter Specification

FIGURE 6-4: DVA-68PL TO 64-PIN TQFP

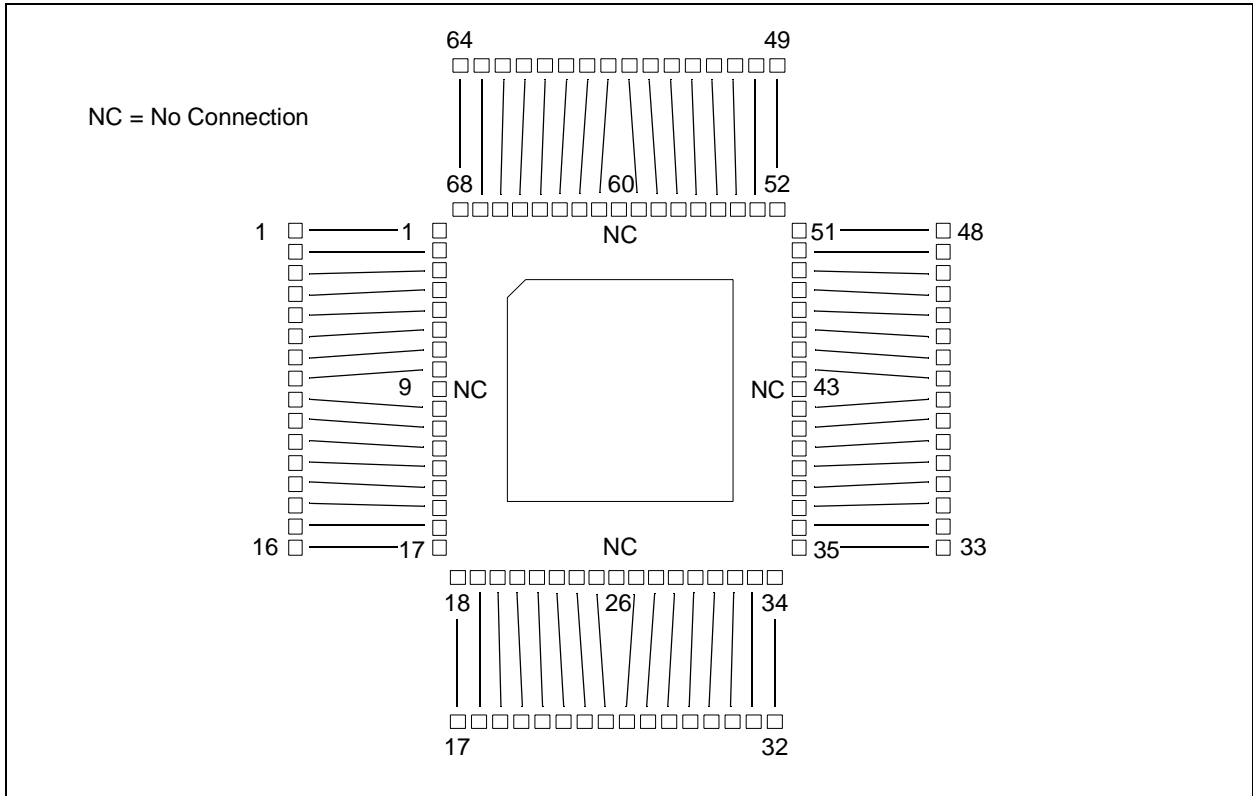

**FIGURE 6-5: DVA-84PL TO 80-PIN TQFP**

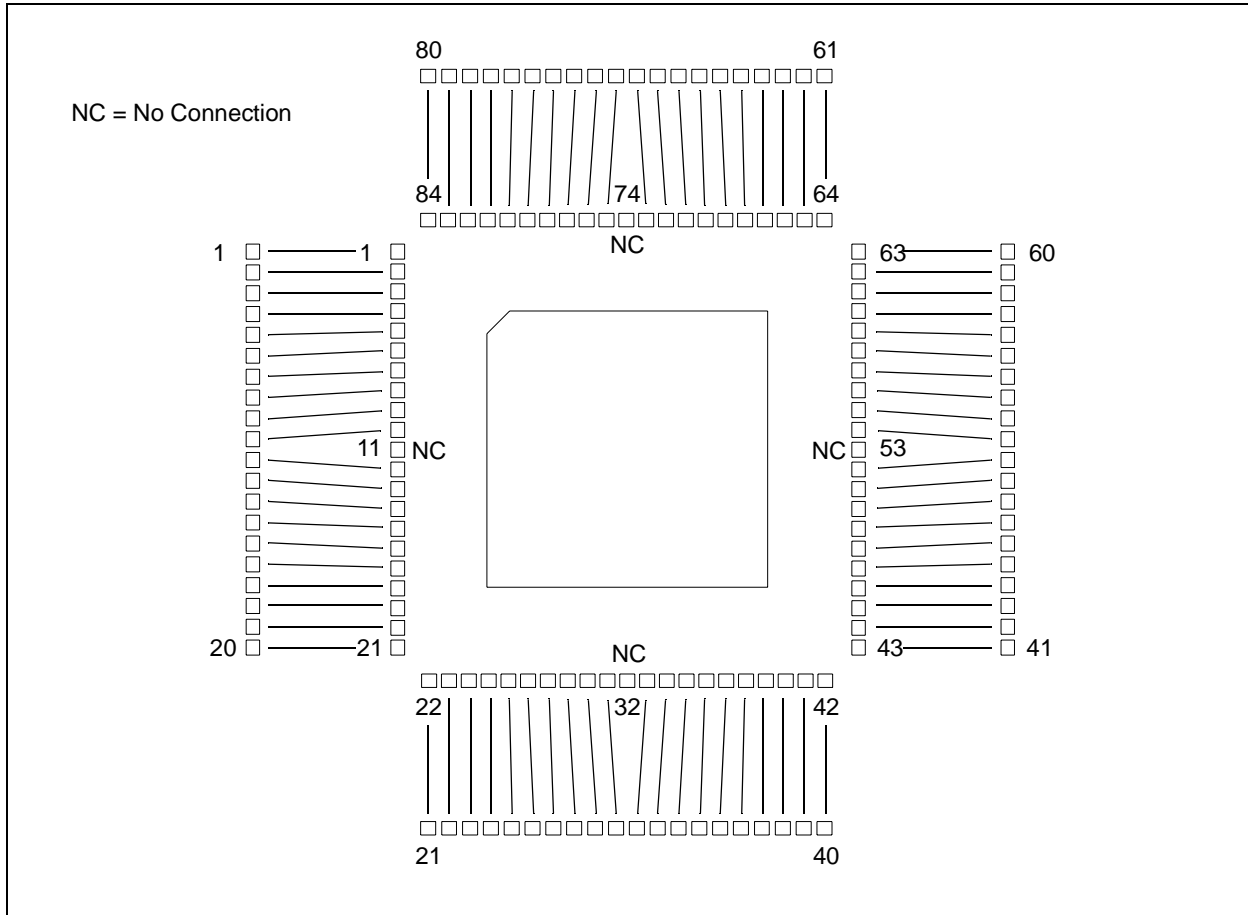



---

---

**Note the following details of the code protection feature on Microchip devices:**

- Microchip products meet the specification contained in their particular Microchip Data Sheet.
- Microchip believes that its family of products is one of the most secure families of its kind on the market today, when used in the intended manner and under normal conditions.
- There are dishonest and possibly illegal methods used to breach the code protection feature. All of these methods, to our knowledge, require using the Microchip products in a manner outside the operating specifications contained in Microchip's Data Sheets. Most likely, the person doing so is engaged in theft of intellectual property.
- Microchip is willing to work with the customer who is concerned about the integrity of their code.
- Neither Microchip nor any other semiconductor manufacturer can guarantee the security of their code. Code protection does not mean that we are guaranteeing the product as "unbreakable."

Code protection is constantly evolving. We at Microchip are committed to continuously improving the code protection features of our products. Attempts to break Microchip's code protection feature may be a violation of the Digital Millennium Copyright Act. If such acts allow unauthorized access to your software or other copyrighted work, you may have a right to sue for relief under that Act.

---

Information contained in this publication regarding device applications and the like is provided only for your convenience and may be superseded by updates. It is your responsibility to ensure that your application meets with your specifications. MICROCHIP MAKES NO REPRESENTATIONS OR WARRANTIES OF ANY KIND WHETHER EXPRESS OR IMPLIED, WRITTEN OR ORAL, STATUTORY OR OTHERWISE, RELATED TO THE INFORMATION, INCLUDING BUT NOT LIMITED TO ITS CONDITION, QUALITY, PERFORMANCE, MERCHANTABILITY OR FITNESS FOR PURPOSE. Microchip disclaims all liability arising from this information and its use. Use of Microchip's products as critical components in life support systems is not authorized except with express written approval by Microchip. No licenses are conveyed, implicitly or otherwise, under any Microchip intellectual property rights.

**Trademarks**

The Microchip name and logo, the Microchip logo, Accuron, dsPIC, KEELOQ, microID, MPLAB, PIC, PICmicro, PICSTART, PRO MATE, PowerSmart, rPIC, and SmartShunt are registered trademarks of Microchip Technology Incorporated in the U.S.A. and other countries.

AmpLab, FilterLab, Migratable Memory, MXDEV, MXLAB, PICMASTER, SEEVAL, SmartSensor and The Embedded Control Solutions Company are registered trademarks of Microchip Technology Incorporated in the U.S.A.

Analog-for-the-Digital Age, Application Maestro, dsPICDEM, dsPICDEM.net, dsPICworks, ECAN, ECONOMONITOR, FanSense, FlexROM, fuzzyLAB, In-Circuit Serial Programming, ICSP, ICEPIC, Linear Active Thermistor, MPASM, MPLIB, MPLINK, MPSIM, PCKIT, PICDEM, PICDEM.net, PICLAB, PICtail, PowerCal, PowerInfo, PowerMate, PowerTool, rLAB, rPICDEM, Select Mode, Smart Serial, SmartTel, Total Endurance and WiperLock are trademarks of Microchip Technology Incorporated in the U.S.A. and other countries.

SQTP is a service mark of Microchip Technology Incorporated in the U.S.A.

All other trademarks mentioned herein are property of their respective companies.

© 2005, Microchip Technology Incorporated, Printed in the U.S.A., All Rights Reserved.

 Printed on recycled paper.

**QUALITY MANAGEMENT SYSTEM**  
**CERTIFIED BY DNV**  
**== ISO/TS 16949:2002 ==**

*Microchip received ISO/TS-16949:2002 quality system certification for its worldwide headquarters, design and wafer fabrication facilities in Chandler and Tempe, Arizona and Mountain View, California in October 2003. The Company's quality system processes and procedures are for its PICmicro® 8-bit MCUs, KEELOQ® code hopping devices, Serial EEPROMs, microperipherals, nonvolatile memory and analog products. In addition, Microchip's quality system for the design and manufacture of development systems is ISO 9001:2000 certified.*



---

---

## WORLDWIDE SALES AND SERVICE

---

---

### AMERICAS

**Corporate Office**  
2355 West Chandler Blvd.  
Chandler, AZ 85224-6199  
Tel: 480-792-7200  
Fax: 480-792-7277  
Technical Support:  
<http://support.microchip.com>  
Web Address:  
[www.microchip.com](http://www.microchip.com)

**Atlanta**  
Alpharetta, GA  
Tel: 770-640-0034  
Fax: 770-640-0307

**Boston**  
Westborough, MA  
Tel: 774-760-0087  
Fax: 774-760-0088

**Chicago**  
Itasca, IL  
Tel: 630-285-0071  
Fax: 630-285-0075

**Dallas**  
Addison, TX  
Tel: 972-818-7423  
Fax: 972-818-2924

**Detroit**  
Farmington Hills, MI  
Tel: 248-538-2250  
Fax: 248-538-2260

**Kokomo**  
Kokomo, IN  
Tel: 765-864-8360  
Fax: 765-864-8387

**Los Angeles**  
Mission Viejo, CA  
Tel: 949-462-9523  
Fax: 949-462-9608

**San Jose**  
Mountain View, CA  
Tel: 650-215-1444  
Fax: 650-961-0286

**Toronto**  
Mississauga, Ontario,  
Canada  
Tel: 905-673-0699  
Fax: 905-673-6509

### ASIA/PACIFIC

**Australia - Sydney**  
Tel: 61-2-9868-6733  
Fax: 61-2-9868-6755

**China - Beijing**  
Tel: 86-10-8528-2100  
Fax: 86-10-8528-2104

**China - Chengdu**  
Tel: 86-28-8676-6200  
Fax: 86-28-8676-6599

**China - Fuzhou**  
Tel: 86-591-8750-3506  
Fax: 86-591-8750-3521

**China - Hong Kong SAR**  
Tel: 852-2401-1200  
Fax: 852-2401-3431

**China - Qingdao**  
Tel: 86-532-8502-7355  
Fax: 86-532-8502-7205

**China - Shanghai**  
Tel: 86-21-5407-5533  
Fax: 86-21-5407-5066

**China - Shenyang**  
Tel: 86-24-2334-2829  
Fax: 86-24-2334-2393

**China - Shenzhen**  
Tel: 86-755-8203-2660  
Fax: 86-755-8203-1760

**China - Shunde**  
Tel: 86-757-2839-5507  
Fax: 86-757-2839-5571

**China - Wuhan**  
Tel: 86-27-5980-5300  
Fax: 86-27-5980-5118

**China - Xian**  
Tel: 86-29-8833-7250  
Fax: 86-29-8833-7256

### ASIA/PACIFIC

**India - Bangalore**  
Tel: 91-80-2229-0061  
Fax: 91-80-2229-0062

**India - New Delhi**  
Tel: 91-11-5160-8631  
Fax: 91-11-5160-8632

**India - Pune**  
Tel: 91-20-2566-1512  
Fax: 91-20-2566-1513

**Japan - Yokohama**  
Tel: 81-45-471-6166  
Fax: 81-45-471-6122

**Korea - Gumi**  
Tel: 82-54-473-4301  
Fax: 82-54-473-4302

**Korea - Seoul**  
Tel: 82-2-554-7200  
Fax: 82-2-558-5932 or  
82-2-558-5934

**Malaysia - Penang**  
Tel: 604-646-8870  
Fax: 604-646-5086

**Philippines - Manila**  
Tel: 632-634-9065  
Fax: 632-634-9069

**Singapore**  
Tel: 65-6334-8870  
Fax: 65-6334-8850

**Taiwan - Hsin Chu**  
Tel: 886-3-572-9526  
Fax: 886-3-572-6459

**Taiwan - Kaohsiung**  
Tel: 886-7-536-4818  
Fax: 886-7-536-4803

**Taiwan - Taipei**  
Tel: 886-2-2500-6610  
Fax: 886-2-2508-0102

**Thailand - Bangkok**  
Tel: 66-2-694-1351  
Fax: 66-2-694-1350

### EUROPE

**Austria - Weis**  
Tel: 43-7242-2244-399  
Fax: 43-7242-2244-393

**Denmark - Copenhagen**  
Tel: 45-4450-2828  
Fax: 45-4485-2829

**France - Paris**  
Tel: 33-1-69-53-63-20  
Fax: 33-1-69-30-90-79

**Germany - Munich**  
Tel: 49-89-627-144-0  
Fax: 49-89-627-144-44

**Italy - Milan**  
Tel: 39-0331-742611  
Fax: 39-0331-466781

**Netherlands - Drunen**  
Tel: 31-416-690399  
Fax: 31-416-690340

**Spain - Madrid**  
Tel: 34-91-352-30-52  
Fax: 34-91-352-11-47

**UK - Wokingham**  
Tel: 44-118-921-5869  
Fax: 44-118-921-5820

08/24/05