

ASM Series • 50/60 Hz Current Sensor

ASM Series current sensors operate as the sealed secondary of a current transformer while the conductor carrying the current to be measured functions as a one turn primary. Measurement accuracy can be improved by increasing the number of primary turns. Applications include detection of branch circuit overload and load drop or shutdown.

Features

- Fully encapsulated for optimal PC board mtg.
- Mains frequency of 50/60 Hz
- Primary current ratings from 1 to 100 Amps
- Primary to secondary isolated to 2500 or 4000VAC
- Operating temperature range: -40° C to +120° C
- Competitive pricing due to high volume production
- Manufactured in an ISO 9001:2015 and ISO 14001:2015 certified Talema facility
- Fully RoHS & REACH Compliant



Part Number	Current Range	Output Voltage Tolerance
ASM-010	1 - 10 Amps	±10%
ASM-020	1 - 20 Amps	±10%
ASM-050	5 - 50Amps	±10%
ASM-075	5 - 75 Amps	±10%
ASM-100	5 - 100 Amps	±10%

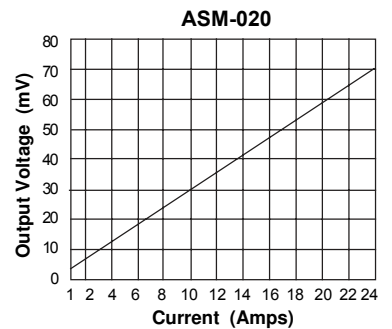
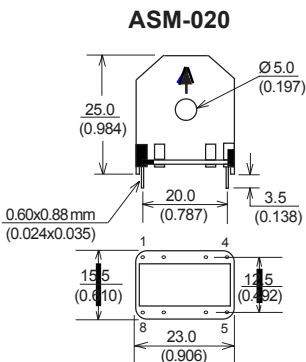
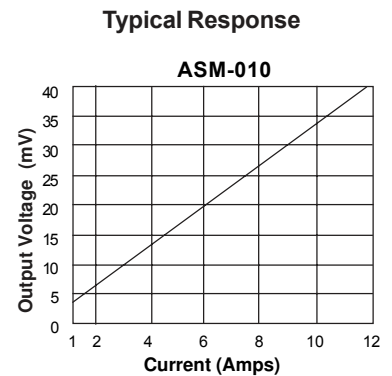
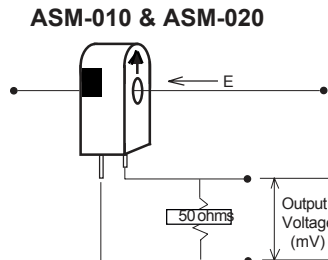
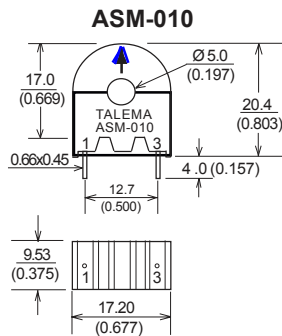

Note: Pins #1 and 8 are Blank

ASM-050, ASM-075 & ASM-100

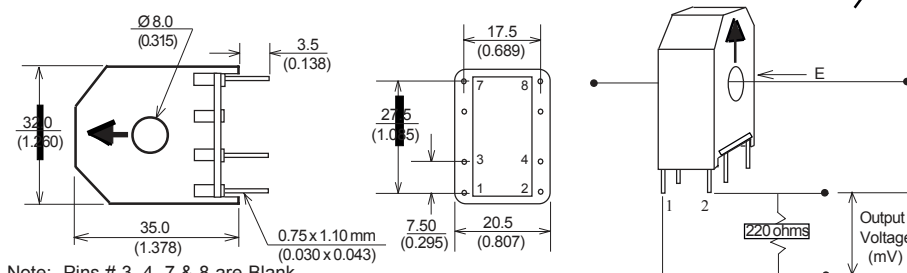

Note: Pins # 3, 4, 7 & 8 are Blank

ASM-050, ASM-075 & ASM-100

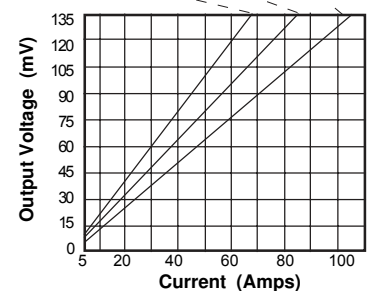

Regional Locations - Design, Manufacturing, Sales & Marketing
Talema Group Regional Offices
North America
**United States
(Sales & Marketing)**

Talema Group, LLC
 PO Box 935
 900 Innovation Drive
 Suite 120, Rolla
 Missouri 65402
 Tel: +1 573-303-3675
 E-Mail:
sales@talemagroup.com
 Web: www.talema.com

Asia
**India
(Design, Manufacturing, Sales & Marketing)**

Administrative Office
Talema Electronic India Private Limited
 Door No. 221, 1st and 2nd Floor
 KJ Plaza, Opp.to Vidya Mandir School
 Meyanoor Main Road
 Salem - 636 004 Tamil Nadu INDIA
 Tel: +91 427 - 243 3100
 Fax: +91 427 - 243 3109
 E-Mail: talema@talemaindia.net
 Web: www.talema.com

Factory Premises
Talema Electronic India Private Limited
 Plot Nos. 30, 31 Electrical and Electronic
 Industrial Estate
 Suramangalam
 Salem - 636 005 Tamil Nadu INDIA
 Tel: +91 427 - 243 3000
 E-Mail: talema@talemaindia.net
 Web: www.talema.com

Europe
**Germany
(Design, Sales & Marketing)**

Talema Elektronik GmbH
 Sembdnerstr. 5
 82110 Germering
 Tel: +49 89 - 841 00 - 0
 Fax: +49 89 - 841 00 25
 E-Mail: info@talema.de
 Web: www.talema.com

**Ireland
(Design, Sales & Marketing)**

Nuvotem TEO
 Units W & X, Gweedore Business Park
 Derrybeg, Letterkenny, Co. Donegal
 Tel: +353 (0) 74 95 48666
 Fax: +353 (0) 74 95 48139
 E-Mail: info@nuvotem.com
 Web: www.nuvotem.com

**Czech Republic
(Design, Manufacturing, Sales & Marketing)**

NT Magnetics s.r.o.
 Chebská 27
 322 00 Plzeň
 Tel: +420 377 - 338 351
 Fax: +420 377 - 338 350
 E-Mail: talema@talema.cz
 Web: www.ntmagnetics.cz

Locations of Talema Group Regional Offices
