

## DESCRIPTION

The EV4031-S-00A Evaluation Board is designed to demonstrate the capabilities of MP4031. The MP4031 is a primary-side-control offline LED lighting controller which can achieve high power factor and accurate current for either Triac dimmable or analog dimmable LED lighting application. It works in boundary conduction mode for reducing the MOSFET and Diode switching losses.

The EV4031-S-00A is typically designed for either driving a 16W Triac dimmable LED bulb with 30V<sub>TYP</sub>, 530mA LED load at 108V-132VAC/60Hz or driving a 16W analog dimmable LED bulb with 30V<sub>TYP</sub>, 530mA LED load at 108-305VAC.

The EV4031-S-00A has an excellent efficiency, can pass 3kV surge test, and meets IEC61000-3-2 Class C harmonics and EN55015 conducted EMI requirements. It has multi-protection function as over-voltage protection, over-current protection, cycle by cycle current limit, etc.

## ELECTRICAL SPECIFICATION

Parameter	Symbol	Value	Units
Input Voltage (Triac dimmable)	V <sub>IN</sub>	108 to 132	VAC
Input Voltage (Analog dimmable)		108 to 305	VAC
Output Voltage	V <sub>OUT</sub>	30	V
LED Current	I <sub>LED</sub>	530	mA
Output Power	P <sub>OUT</sub>	16	W
Efficiency (full load)	η	>82	%
Power Factor	PF	>0.9	
THD	THD	<20	%

## FEATURES

- Fast Start up
- Triac Dimmable, with 1% to 100% dimming range and the dimming curve meets standard SSL6
- Analog-Dimmable
- Real current control without secondary-feedback circuit
- Unique architecture for superior line regulation
- High power factor>0.9 over 108Vac to 305Vac
- Boundary conduction mode improves efficiency
- Input UVLO
- Cycle-by-cycle current limit
- Over-voltage protection (OVP)
- Over-current protection (OCP)
- Over-temperature protection (OTP)
- Fit inside PAR38 bulb enclosure

## APPLICATIONS

- Solid State Lighting
- Industrial & Commercial Lighting
- Residential Lighting

All MPS parts are lead-free and adhere to the RoHS directive. For MPS green status, please visit MPS website under Quality Assurance. "MPS" and "The Future of Analog IC Technology", are Registered Trademarks of Monolithic Power Systems, Inc.



**Warning:** Although this board is designed to satisfy safety requirements, the engineering prototype has not been agency approved. Therefore, all testing should be performed using an isolation transformer to provide the AC input to the prototype board.

## EV4031-S-00A EVALUATION BOARD

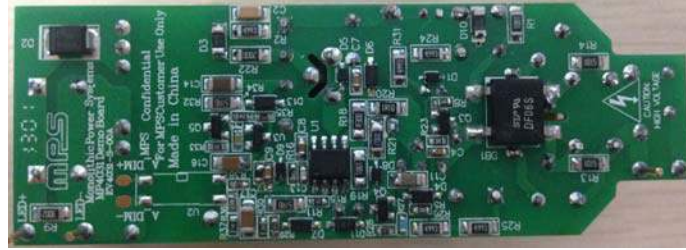

(L x W x H) 86mm x 30mm x 29mm

Board Number	MPS IC Number
EV4031-S-00A	MP4031GS

## EVALUATION BOARD SCHEMATIC

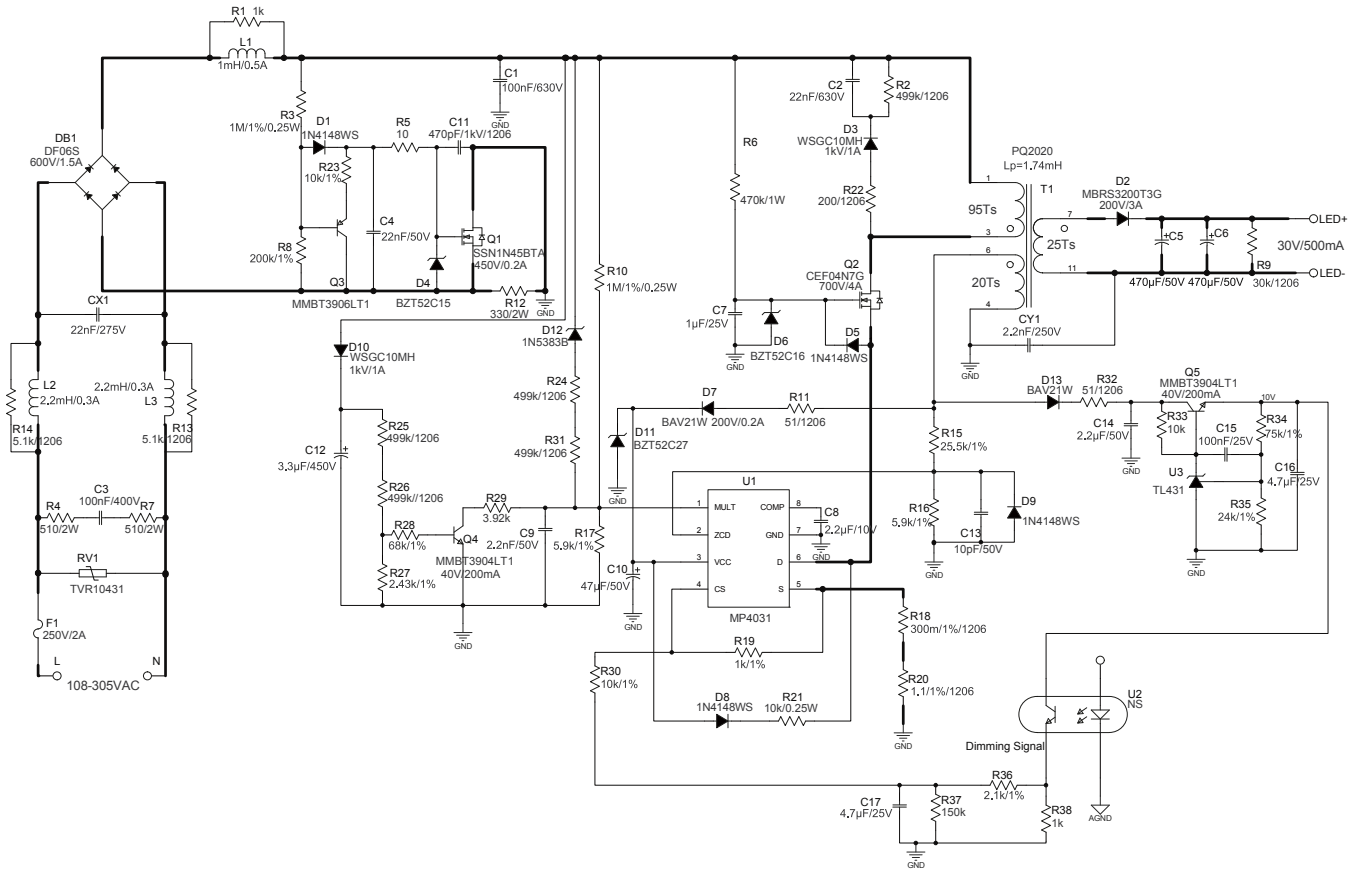

Figure 1—Schematic

### PCB LAYOUT

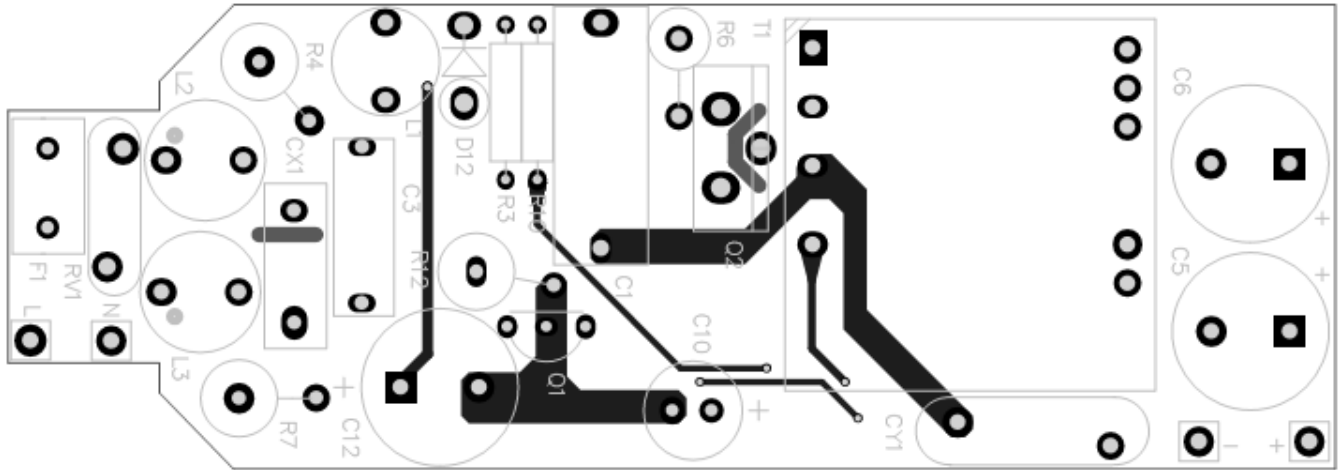

Figure 2—Top Layer

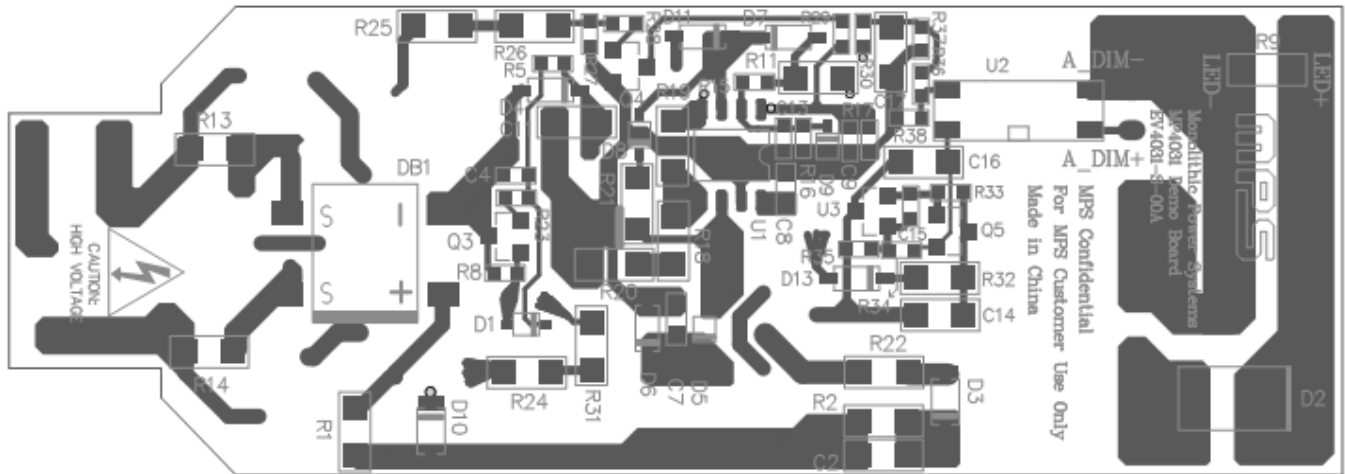

Figure 3—Bottom Layer

## CIRCUIT DESCRIPTION

The EV4031-S-00A is configured in a single-stage Flyback topology, it uses primary-side-control which can mostly simplify the schematic and get a cost effective BOM. It can also achieve high power factor and accurate LED current.

F1, L1, L2, L3, R1, R14, R13, CX1, DB1, and C1 compose the input stage. F1 fuses the AC input to protect for the component failure or some excessive short events. L1, L2, L3, R1, R14, CX1, R13 and C1 associated with CY1 form the EMI filter which can meet the standard EN55015. The diode rectifier DB1 rectifies the input line voltage. Small bulk CBB capacitor C1 is used as a low impedance path for the primary switching current, to maintain high power factor, the capacitance of C1 should be selected with low value.

RV1, D10, R25, R26, R27, C12 are used for surge test. RV1 can make sure the circuit pass 500V surge test, for higher level test, a RCD snubber composed of D10, R25, R26, R27 and C12 is needed.

R3, R8, R5, R23, C4, C11, D1, D4, Q1, Q3 with R12 compose the damping circuit for reducing the inrush current at the dimmer turning on time. The circuit let the inrush current flow through R12 at first when triac dimmer turns on. Then Q1 turns on and shorts R12, this can save power from R12. Q3 is used to discharge C4 when the triac is off. D4 is used to clamp the gate voltage of Q1 to 15V.

R4, R7, C3 are used as a bleeder circuit which keeping the triac current above the minimum holding current after triac turns on.

R10, R17, C9 provide sine wave reference for the primary peak current to get an active PFC function. R28 and Q4 parallels R29 with R17, when the input voltage is high, which make sure the MULT pin voltage lower than the max voltage rating, and improves the line regulation in wide input voltage range application.

D12, R24, R31 are used to improve the THD performance at high side input, which is useful in wide input voltage range application.

R11, D7, C10, D11 are used to supply power for MP4031. A 47 $\mu$ F bulk capacitor C10 is selected to maintain the supply voltage. At start-up, C10 is first charged up through the external MOSFET Q2 and internal charging circuit, when the VCC voltage reaches 10V, the internal charging circuit stops charging and the control logic works. Then the power supply is taken over by the auxiliary winding through R11, D7.

R6, C7, D6 and D5 are used for the gate drive of the external MOSFET Q2.

R15, R16, C13, D9 are used to detect the auxiliary winding to get the transformer magnetizing current zero crossing signal for realizing the boundary conduction operation, and also monitor the output OVP condition. The OVP voltage is set by the divider ratio of R15, R16. R21 and D8 are used to restrain the oscillation between the leakage inductor and the parasitical capacitor when OVP happens. If the oscillation happens, the external MOSFET will be turned on/off abnormally and the part can't work in auto restart mode.

U2 is an Optocoupler which optically couples the PWM dimming signal from the secondary side to the primary side. R36, R37, R38, and C17 convert the PWM signal into an analog signal, which is divided by R30 and R19, then put into CS pin.

D13, R32, C14, Q5, R33, C15, U3, R34, R35, C16 compose a LDO, which is the power supply for Optocoupler.

R18, R20 are primary sensing resistors for primary side current control. The value of R18, R20 set the output LED current. C2, R2, R22, D3 are used to damp the leakage inductance energy so the drain voltage can be suppressed at a safe level.

Diode D2 rectifies the secondary winding voltage and the capacitor C5, C6 are the output filter. The resistor R9 is placed as pre-load to limit the output voltage rise too high in open load condition.

**EV4031-S-00A BILL OF MATERIALS**

Qty	Ref	Value	Description	Package	Manufacture	Part Number
1	C1	100nF	Ceramic Capacitor; 630V;10%	DIP	Fala	C312J104K63CC30
1	C2	22nF	Ceramic Capacitor; 630V;X7R;1206	1206	TDK	C3216X7R2J223K
1	C3	100nF	Capacitor;400V; CBB	DIP	Panasonic	ECQE4104KF
1	C4	22nF	Ceramic Capacitor; 50V;X7R;0603;	0603	muRata	GRM188R71H223KA01D
2	C5,C6	470μF	Electrolytic Capacitor; 50V;Electrolytic	DIP	Jianghai	CD263-50V470
1	C7	1μF	Ceramic Capacitor; 25V;X7R;0603	0603	muRata	GRM188R71E105KA12D
1	C8	2.2μF	Ceramic Capacitor; 10V;X7R;0603	0603	muRata	GRM188R71A225KE15D
1	C9	2.2nF	Ceramic Capacitor; 50V;X7R;0603;	0603	TDK	C1608X7R1H222K
1	C10	47μF	Electrolytic Capacitor; 50V;Electrolytic	DIP	Jianghai	CD263-50V47
1	C11	470pF	Ceramic Capacitor; 1kV;1206	1206	muRata	GRM31B7U3A471JW31L
1	C12	3.3μF	Electrolytic Capacitor; 450V;Electrolytic	DIP	LangRui	PX 450V/3.3uF
1	C13	10pF	Ceramic Capacitor; 50V;X7R;0603;	0603	muRata	GRM1885C1H100JA01
1	C14	2.2μF	Ceramic Capacitor; 50V;X7R;1206;	1206	muRata	GJ8319R61H225K
1	C15	100nF	Ceramic Capacitor; 25V;X7R;0603;	0603	muRata	GRM188R71E104KA01D
2	C16, C17	4.7μF	Ceramic Capacitor; 25V;X7R;1206;	1206	muRata	GRM31CR71E475KA88L
1	CX1	22nF	Capacitor;275V;10%	DIP	Carli	PX223K31B19L270D9R
1	CY1	2.2nF	Capacitor;4000V; 20%	DIP	Hongke	JNK12E222MY02N
4	D1,D5, D8,D9	1N4148WS	Diode;75V;0.15A;	SOD-323	Diodes	1N4148WS-7-F
1	D2	MBRS320T3G	Diode;200V;3A	SMB	Qianlongxin	MBRS320T3G
2	D3, D10	WSGC10MH	Diode;1000V;1A	1206	MaxMega	WSGC10MH
1	D4	BZT52C15	Zener Diode; 15V;5mA/500mW;	SOD-123	Diodes	BZT52C15
1	D6	BZT52C16	Zener Diode; 16V;5mA/500mW;	SOD-123	Diodes	BZT52C16
2	D7, D13	BAV21W	Diode;200V;0.2A;	SOD-123	Diodes	BAV21W-7-F
1	D11	BZT52C27	Zener Diode; 27V;5mA/500mW;	SOD-123	Diodes	BZT52C27
1	D12	1N5383B	Zener Diode; 150V;5W;	DIP	Bangdayuan	1N5383B
1	DB1	DF06S	Diode;600V;1.5A	SMD	Fairchild	DF06S

**EV4031-S-00A BILL OF MATERIALS (continued)**

Qty	Ref	Value	Description	Package	Manufacture	Part Number
1	F1	SS-5-2A	Fuse;250V;2A	DIP	Cooper Bussmann	SS-5-2A
1	L1	1mH	Inductor;1000uH; 2.08 Ohm;0.5A	DIP	Würth	768772102
2	L2,L3	2.2mH	Inductor;2.2mH;4.73 Ohm;0.3A	DIP	Würth	7447720222
1	Q1	SSN1N45BTA	N-Channel Mosfet; 450V;	TO-92	Fairchild	SSN1N45BTA
1	Q2	CEF04N7G	Mosfet;700V;4A	TO-220F	MAXMEGA	CEF04N7G
1	Q3	MMBT3906LT1	Transistor;-40V;-0.2A;	SOT-23	ON Semi	MMBT3906LT1
2	Q4,Q5	MMBT3904LT1	Transistor;40V;0.2A;	SOT-23	ON Semi	MMBT3904LT1
2	R1,R19	1kΩ	Film Resistor; 1%;1/4W	1206	Hottechohm	RI1206L1001FT
2	R13, R14	5.1kΩ	Resistor;1%;1/4W	1206	Yageo	RC1206FR-075K1L
5	R2, R24, R25, R26, R31	499kΩ	Film Resistor;1%;	1206	Yageo	RC1206FR-07499KL
2	R3,R10	1MΩ	Resistor;1%;1/4W	DIP	any	1M Ohm
2	R4,R7	510Ω	Resistor;5%;2W	DIP	any	510 Ohm/2W
1	R5	10Ω	Film Resistor;1%;	0603	Yageo	RC0603FR-0710RL
1	R6	470kΩ	Resistor;5%;1W	DIP	any	470K Ohm
1	R8	200kΩ	Film Resistor;1%	0603	Yageo	RC0603JR-07200KL
1	R9	30kΩ	Resistor;1%	1206	Yageo	RC1206FR-0730KL
2	R11, R32	51Ω	Film Resistor;1%	1206	Yageo	RC1206FR-0751RL
1	R12	330Ω	Resistor;5%;2W	DIP	any	330 Ohm/ 2W
1	R15	25.5kΩ	Film Resistor;1%;	0603	Yageo	RC0603FR-0725K5L
2	R16, R17	5.9kΩ	Film Resistor;1%	0603	Yageo	RC0603FR-075K9L
1	R18	300mΩ	Resistor;1%	1206	Yageo	RL1206FR-070R3L
1	R20	1.1Ω	Resistor;1%	1206	Yageo	RC1206FR-071R1L
1	R21	10kΩ	Resistor;5%	1206	Yageo	RM12JTN103
1	R22	200Ω	Resistor;5%	1206	Yageo	RC1206FR-07200RL
4	R23, R30, R33, R38	10kΩ	Film Resistor;1%	0603	Yageo	RC0603FR-0710KL
1	R27	2.43kΩ	Film Resistor;1%	0603	Yageo	RC0603FR-072K43L
1	R28	68kΩ	Film Resistor;1%	0603	Yageo	RC0603FR-0768KL
1	R29	3.92kΩ	Film Resistor;1%	0603	Yageo	RC0603FR-073K92L
1	R34	75kΩ	Film Resistor;1%	0603	Yageo	RC0603FR-0775KL
1	R35	24kΩ	Film Resistor;1%	0603	Yageo	RC0603FR-0724KL

**EV4031-S-00A BILL OF MATERIALS (continued)**

Qty	Ref	Value	Description	Package	Manufacture	Part Number
1	R36	2.1kΩ	Film Resistor;1%	0603	Yageo	RC0603FR-072K1L
1	R37	150kΩ	Film Resistor;1%	0603	Yageo	RC0603JR-07150KL
1	R38	1kΩ	Film Resistor;1%	0603	Yageo	RC0603FR-071KL
1	RV1	TVR10431	THERMAL R	DIP	TSK	TVR10431KSY
1	T1	FX0302	PQ2020 L=1.74mH, Np:Ns:Naux=95:25:20	DIP	Emei	FX0302
1	U1	MP4031GS	TRIAIC Dimmable, Analog Dimmable, Offline LED Lighting Controller	SOIC8	MPS	MP4031GS-Z
1	U2	NS				
1	U3	CJ431	CJ431;2.5V	SOT-23	Changdian	CJ431

### TRANSFORMER SPECIFICATION

#### Electrical Diagram

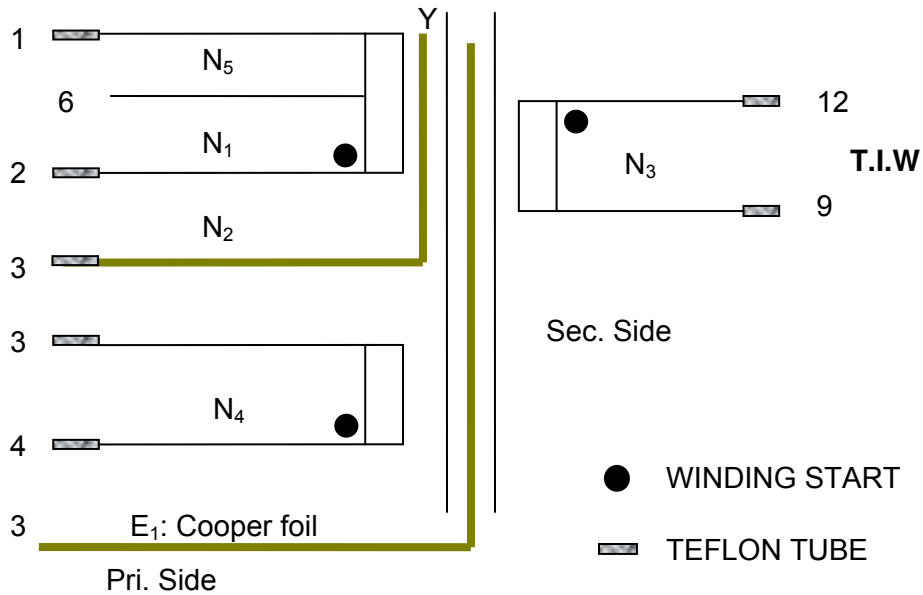

Figure 4—Transformer Electrical Diagram

**Notes:**

1. Don't connect Y to any pin of Bobbin.
2. E<sub>1</sub> is one layer of cooper foil applied to core, and connected to PIN3 by a wire.

#### Winding Diagram

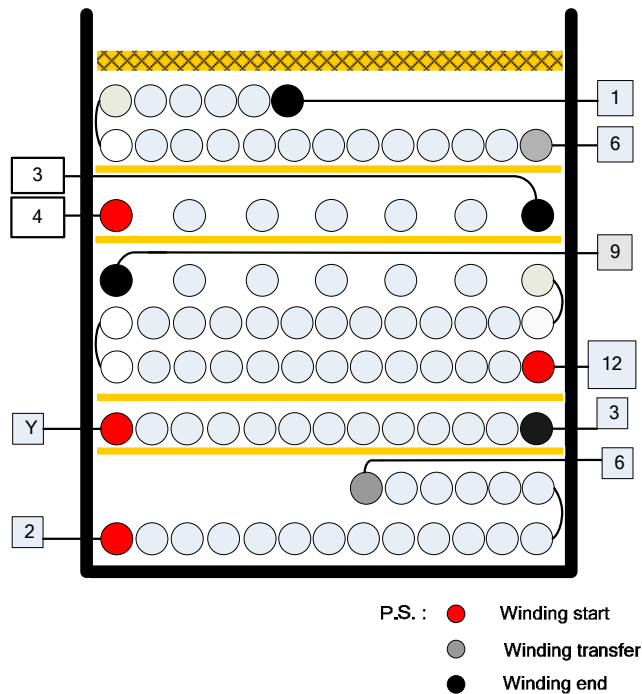

Figure 5—Winding Diagram



**Winding Order**

Winding No.	Tape Layer Number	Start & End	Magnet Wire $\Phi$ (mm)	Turns
N <sub>1</sub>	2	2→6	0.23mm * 1	47
N <sub>2</sub>	2	3→Y	0.15mm * 1	one layer
N <sub>3</sub>	2	12→9	0.30mm * 2 (T.I.W)	25
N <sub>4</sub>	2	4→3	0.15mm * 1	20
N <sub>5</sub>	3	6→1	0.23mm * 1	48
E <sub>1</sub>	3		One layer Cooper foil	

**Electrical Specifications**

<b>Electrical Strength</b>	60 second, 60Hz, from PRI. to SEC.	2500VAC
	60 second, 60Hz, from PRI. to CORE.	1000VAC
	60 second, 60Hz, from SEC. to CORE.	1000VAC
<b>Primary Inductance</b>	Pins 1 - 2, all other windings open, measured at 60kHz, 0.1 VRMS	1.74mH±5%
<b>Primary Leakage Inductance</b>	Pins 1 - 2 with all other pins shorted, measured at 100kHz. 0.1 VRMS	45μH (max)

**Materials**

Item	Description
1	Core: PQ2020, UI=2400±25%, AL=3000nH/N <sup>2</sup> ±25% UNGAPPED, AL=192.7nH/N <sup>2</sup> ±3% GAPPED SUNSHINE: pq2020, SSP-4 or equivalent
2	Bobbin: PQ202020, 6+8PIN RMMOVE PIN5,6,7,8,11 1SECT THT375J UL94V-0 CHANG CHUN PLASTICS CO LTD RUIQIDANENG
3	Wire: $\Phi$ 0.23mm/ $\Phi$ 0.15mm,, UEW, TAI-I ELECTRIC WIRE&CABLE CO.,LTD or equivalent
4	Triple Insulation Wire: $\Phi$ 0.30mm,TRW(B) GREAT LEONFLON INDUSTRIAL CO.,LTD or equivalent
5	TFL TUBE: AWG#20/30, CLEAR GREAT HOLDING INDUSTRIAL CO LTD
7	COOPER FOIL: 5.0X0.025mm(TH) DONGGUAN CITY RONGQIANG ELECTRONICS or equivalent
8	Tape: 12mm(W)×0.06mm YELLOW, Jingjiang Yahua Presure Sensitive Glue Co.,Ltd CT-280
9	Varnish: JOHN C. DOLPH CO, BC-346A or equivalent
10	Solder Bar: CHENG NAN: SN99.5/Cu0.5 or equivalent

## EVB TEST RESULTS

### Performance Data

#### Efficiency, PF and THD

f (Hz)	Vin(V)	Pin(W)	Vout(V)	Iout(mA)	Pout(W)	Efficiency(%)	PF	THD(%)
60	108	19.11	29.83	529	15.78007	82.6	0.991	11.60
	110	19.05	29.83	529	15.78007	82.8	0.991	11.70
	120	18.69	29.81	527	15.70987	84.1	0.989	12.40
	130	18.37	29.8	526	15.6748	85.3	0.989	12.80
	140	18.17	29.79	524	15.60996	85.9	0.988	13.00
f (Hz)	Vin(V)	Pin(W)	Vo(V)	Io(mA)	Po(W)	Efficiency(%)	PF	THD(%)
50	185	17.81	29.77	522	15.53994	87.3	0.974	15.30
	190	17.78	29.76	522	15.53472	87.4	0.973	15.40
	200	17.79	29.76	522	15.53472	87.3	0.970	15.60
	210	17.80	29.76	522	15.53472	87.3	0.965	15.80
	220	17.82	29.75	522	15.5295	87.1	0.961	16.40
	230	17.88	29.74	522	15.52428	86.8	0.955	16.80
	240	17.92	29.74	522	15.52428	86.6	0.950	17.90
	250	18.01	29.75	522	15.5295	86.2	0.944	18.10
	260	18.08	29.75	522	15.5295	85.9	0.937	18.60
	270	18.16	29.74	523	15.55402	85.6	0.930	18.70
	280	18.24	29.74	523	15.55402	85.3	0.923	18.80
	290	18.32	29.74	523	15.55402	84.9	0.916	18.90
	300	18.44	29.74	524	15.58376	84.5	0.909	19.00

**TRIAC Dimming Compatibility (No Flicker with these 25 different Dimmers)**

Manufacturer	Part No.	Power Stage	Dimming Type	Io_max (mA)	Io_min (mA)	Dimming Ratio (%)	Min start current (mA)
LUTRON	6B38-DVLV-600P	600W	Leading	445	1	0.22	2
LUTRON	6B38-DV-603PG	600W	Leading	309	1	0.32	3
LUTRON	6B38-S-600P	600W	Leading	445	0	0.00	2
LUTRON	6B38-S-603PG	600W	Leading	306	0	0.00	2
LUTRON	S-600	600W	Leading	520	0	0.00	8
LUTRON	6B38	600W	Leading	463	2	0.43	7
LUTRON	AY-600P	600W	Leading	430	4	0.93	13
LUTRON	6B38	400W	Leading	427	0	0.00	47
LUTRON	TG-603GH-WH	600W	Leading	275	4	1.45	12
LUTRON	TG-600PH-WH	600W	Leading	459	6	1.31	12
LUTRON	GLS01-C06570	600W	Leading	318	0	0.00	48
LEVITON	6633-P	600W	Leading	514	0	0.00	7
LUTRON	6B38-Q-600P	600W	Leading	470	5	1.06	17
LEVITON	6633-P	600W	Leading	517	0	0.00	9
LUTRON	6B38-DV-600P	600W	Leading	437	0	0.00	2
COOPER	6B28	600W	Leading	502	0	0.00	49
LEVITON	1L1005	600W	Leading	472	0	0.00	13
LUTRON	LG600P	600W	Leading	459	1	0.22	1
LEVITON	1G4005	600W	Leading	469	0	0.00	17
LEVITON	C20-6684-IW	600W	Leading	531	0	0.00	32
LUTRON	Q-600P-IV	600W	Leading	482	7	1.45	12
LUTRON	DV-600P-BR	600W	Leading	449	1	0.22	7
LUTRON	DVPDC-203P-WH	200W	Leading	514	51	9.92	50
LUTRON	AY-600P-LA	600W	Leading	519	11	2.12	11
LUTRON	GL-600H-DK	600W	Leading	517	0	0.00	4

### Electric Strength Test

Primary circuit to secondary circuit electric strength testing was completed according to IEC61347-1 and IEC61347-2-13.

Input and output was shorted respectively. 3750VAC/50Hz sine wave applied between input and output for 1min, and operation was verified.

### Surge Test

Line to Line 3000V surge testing was completed.

Input voltage was set at 230VAC/50Hz. Output was loaded at full load and operation was verified following each surge event.

Surge Level (V)	Input Voltage (VAC)	Injection Location	Injection Phase (°)	Test Result (Pass/Fail)
3000	230	L to N	0	Pass
-3000	230	L to N	0	Pass
3000	230	L to N	90	Pass
-3000	230	L to N	90	Pass
3000	230	L to N	270	Pass
-3000	230	L to N	270	Pass

### Thermal Test

Test without dimmer and with dimmer at 90% dimming on phase.

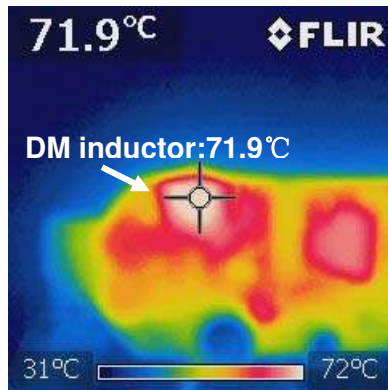

Without dimmer @110Vac

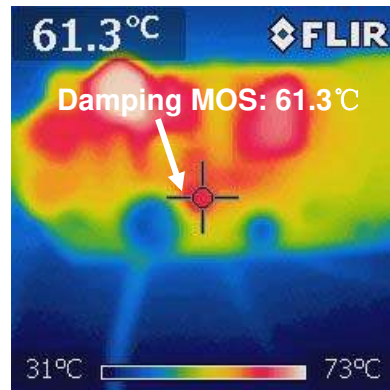

Without dimmer @110Vac

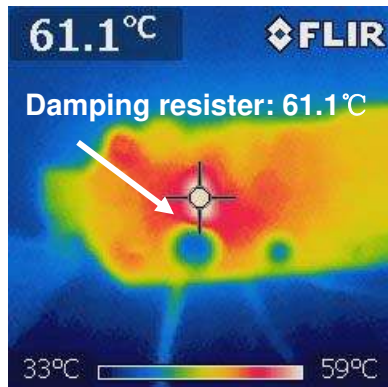

With dimmer at 90% dimming on phase

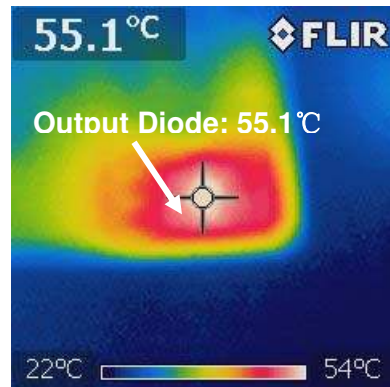

OCP

## EVB TEST RESULTS

Performance waveforms are tested on the evaluation board.

$V_{IN}=108-305VAC$ , 9 LEDs in series,  $I_{LED}=530mA$ ,  $V_{OUT}=30V$ ,  $L_P=1.74mH$ ,  $N_P:N_S:N_{AUX}=95:25:20$

### Conducted EMI

$V_{IN}=110Vac/50Hz$ , Full Load  
L Line, RBW=9kHz, MT=20ms

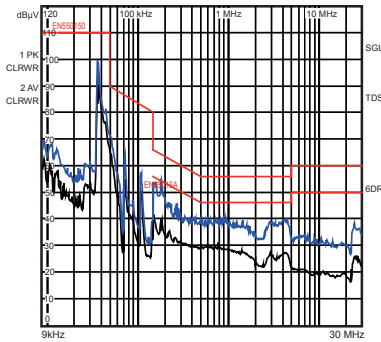

### Conducted EMI

$V_{IN}=110Vac/50Hz$ , Full Load  
N Line, RBW=9kHz, MT=20ms

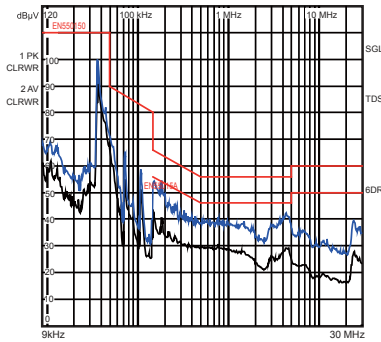

### Conducted EMI

$V_{IN}=230Vac/50Hz$ , Full Load  
L Line, RBW=9kHz, MT=20ms

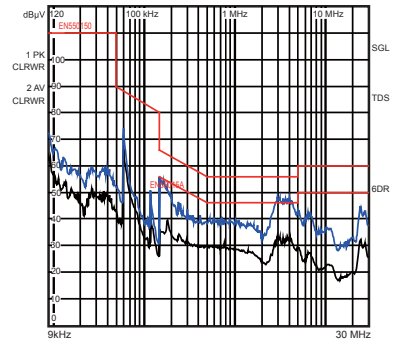

### Conducted EMI

$V_{IN}=230Vac/50Hz$ , Full Load  
N Line, RBW=9kHz, MT=20ms

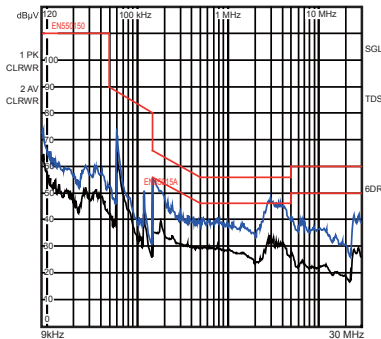

### TRIAC Dimming Curve

$V_{IN}=120Vac/60Hz$ ,  
Full Load with different Dimmers

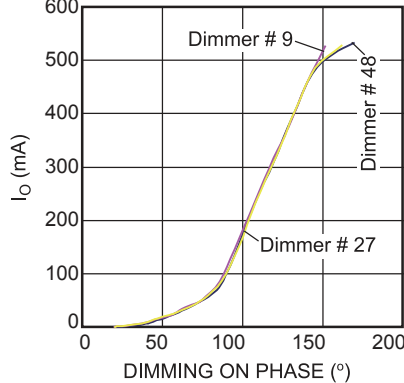

### Line Regulation

Full Load

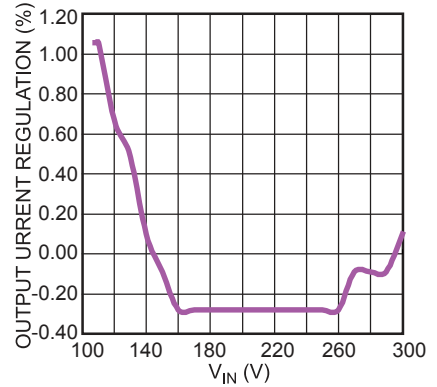

### PF vs. $V_{IN}$

$V_{IN}=(85-135)Vac/60Hz$ , Full Load

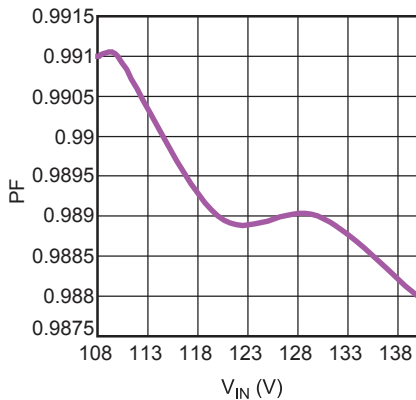

### PF vs. $V_{IN}$

$V_{IN}=(185-265)Vac/50Hz$ , Full Load

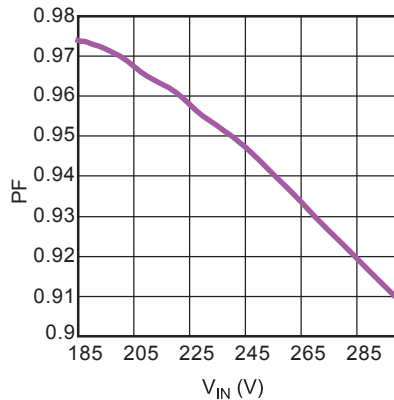

### THD vs. $V_{IN}$

$V_{IN}=(85-135)Vac/60Hz$ , Full Load

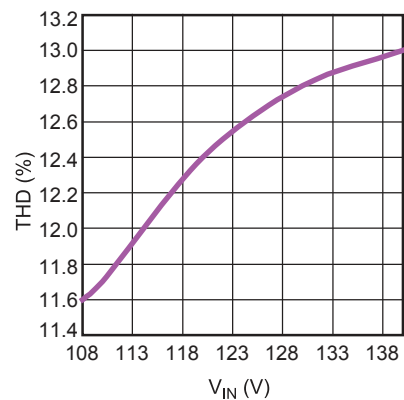

### EVB TEST RESULTS *(continued)*

Performance waveforms are tested on the evaluation board.

$V_{IN}=108-305VAC$ , 9 LEDs in series,  $I_{LED}=530mA$ ,  $V_{OUT}=30V$ ,  $L_P=1.74mH$ ,  $N_P:N_S:N_{AUX}=95:25:20$ .

THD vs.  $V_{IN}$

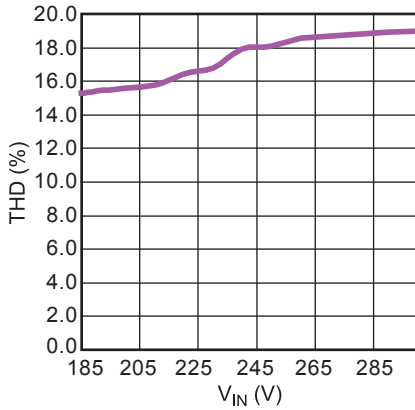

Efficiency vs.  $V_{IN}$

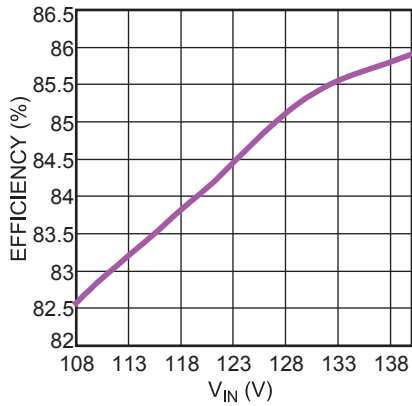

Efficiency vs.  $V_{IN}$

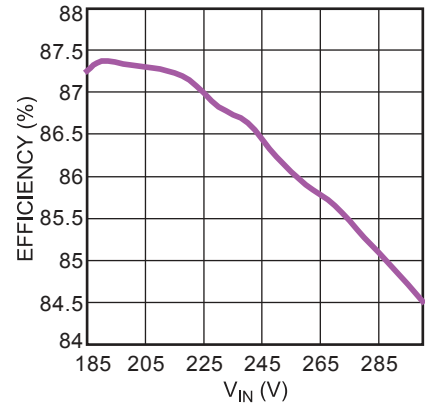

Analog Dimming Curve @ 110 Vac

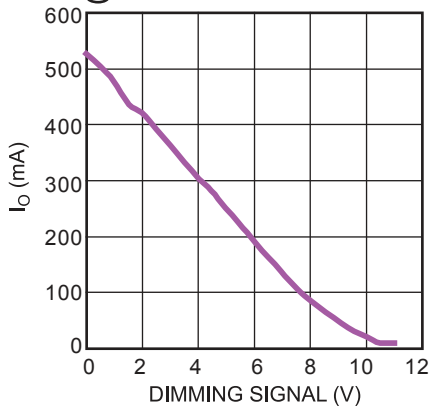

Analog Dimming Curve @ 220 Vac

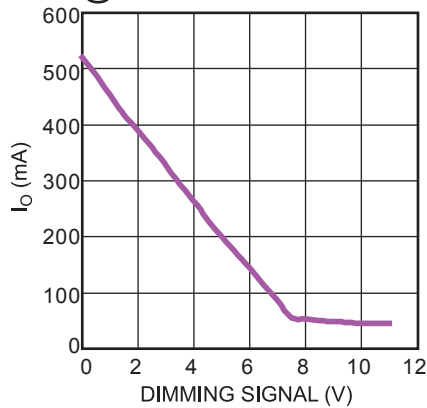

Analog Dimming Curve @ 265 Vac

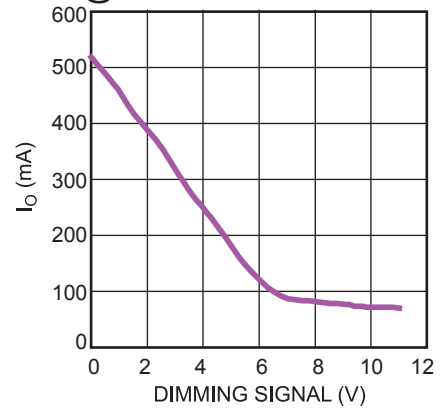

## EVB TEST RESULTS *(continued)*

Performance waveforms are tested on the evaluation board.

$V_{IN}=108-305VAC$ , 9 LEDs in series,  $I_{LED}=530mA$ ,  $V_{OUT}=30V$ ,  $L_P=1.74mH$ ,  $N_P:N_S:N_{AUX}=95:25:20$ .

**Input Voltage and Current**

$V_{IN} = 110Vac/60Hz$ , Full Load

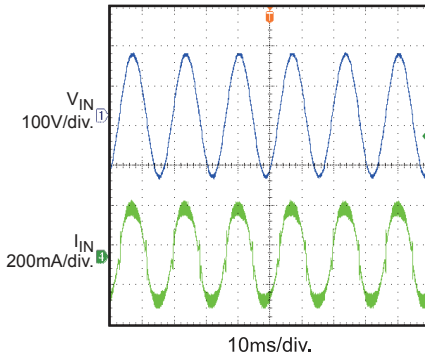

**Input Voltage and Current**

$V_{IN} = 220Vac/50Hz$ , Full Load

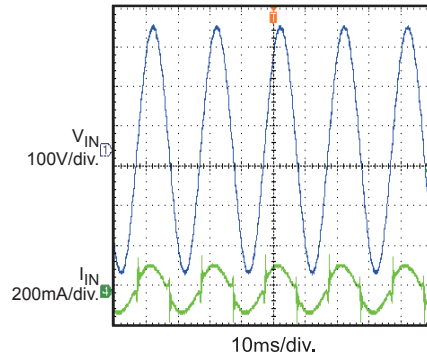

**Steady State**

$V_{IN} = 110Vac/60Hz$ , Full Load

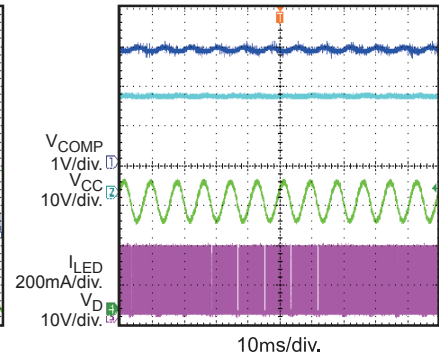

**Steady State**

$V_{IN} = 220Vac/50Hz$ , Full Load

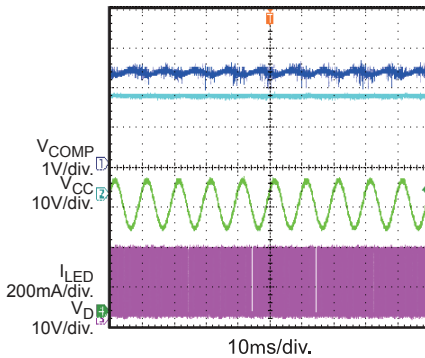

**VIN Start Up**

$V_{IN} = 110Vac/60Hz$ , Full Load

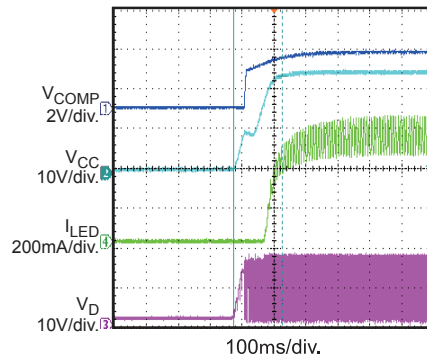

**VIN Start Up**

$V_{IN} = 220Vac/50Hz$ , Full Load

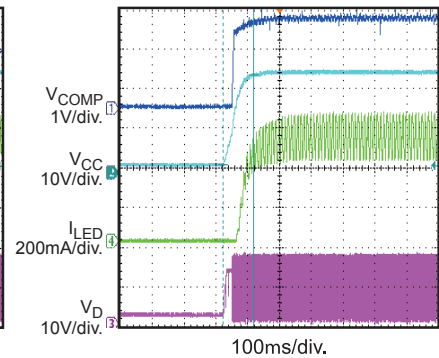

**OVP**

LED Load open when working and then recovery

$V_{IN} = 110Vac/60Hz$ , Full Load

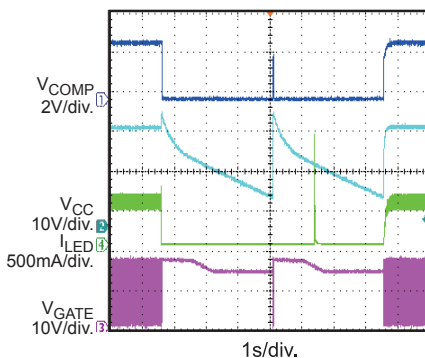

**OVP**

LED Load open when working and then recovery

$V_{IN} = 220Vac/50Hz$ , Full Load

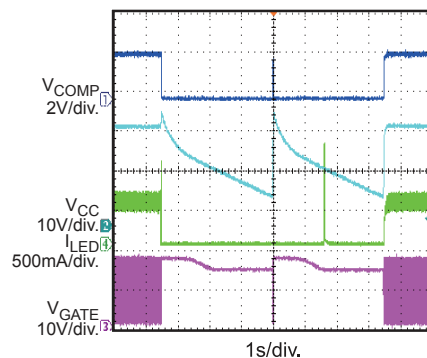

**OCP**

LED+ Short to LED- when working and then recovery

$V_{IN} = 110Vac/60Hz$ , Full Load

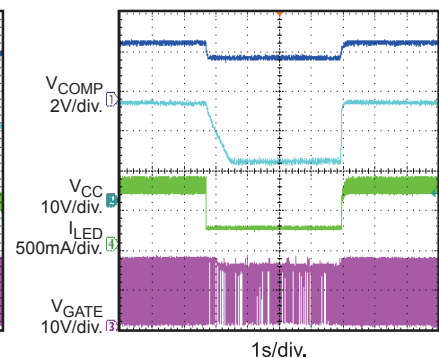

**EVB TEST RESULTS (continued)**

Performance waveforms are tested on the evaluation board.

 $V_{IN}=108-305VAC$ , 9 LEDs in series,  $I_{LED}=530mA$ ,  $V_{OUT}=30V$ ,  $L_P=1.74mH$ ,  $N_P:N_S:N_{AUX}=95:25:20$ .

**OCP**

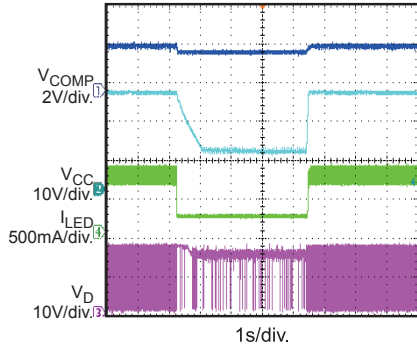
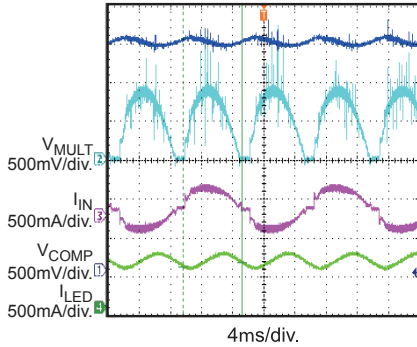
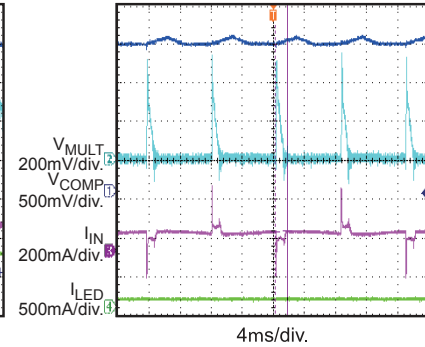
 LED+ Short to LED- when working and then recovery  
 $V_{IN} = 220Vac/50Hz$ , Full Load

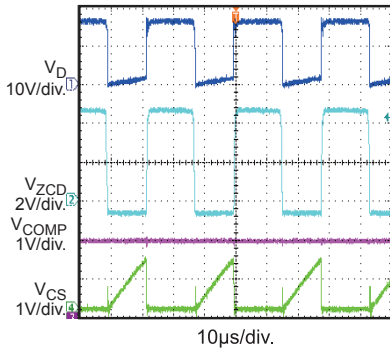
**TRIAC Dimming Performance Max Dimming on Phase**
 $V_{IN} = 110Vac/60Hz$ , Full Load

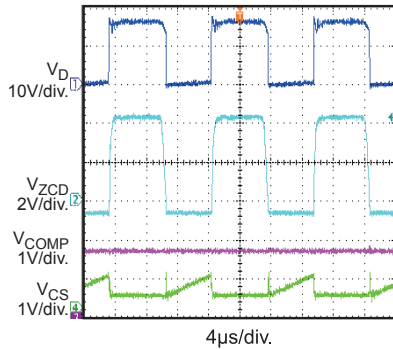
**TRIAC Dimming Performance Min Dimming on Phase**
 $V_{IN} = 110Vac/10Hz$ , with dimmer

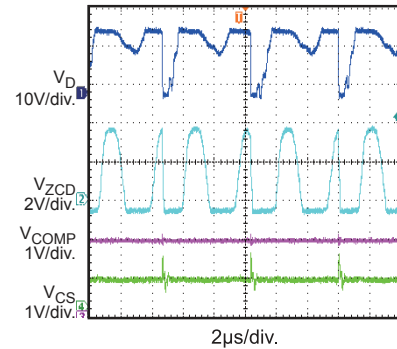
**Analog Dimming Performance**

 Dimming Signal=0V,  
 $V_{IN} = 110Vac/60Hz$ 

**Analog Dimming Performance**

 Dimming Signal=5.1V,  
 $V_{IN} = 110Vac/60Hz$ 

**Analog Dimming Performance**

 Dimming Signal=10V,  
 $V_{IN} = 110Vac/60Hz$ 



## QUICK START GUIDE

1. Preset AC Power Supply to  $108\text{VAC} \leq V_{\text{IN}} \leq 305\text{VAC}$ .
2. Turn Power Supply off.
3. Connect the LED string between “LED+” (anode of LED string) and “LED-” (cathode of LED string).
4. Connect Power Supply terminals to AC  $V_{\text{IN}}$  terminals as shown on the board.
5. Turn AC Power Supply on after making connections.
6. For Triac dimming LED lighting application, especially in deep dimming situation, the LED would shimmer caused by the dimming on duty which is not all the same in every line cycle. What's more, the Grid has noise or inrush which would bring out shimmer even flicker. The suppressor circuit would help to improve this. For detailed information please refer to appendix.

## APPENDIX

### RIPPLE SUPPRESSOR

(Innovative Proprietary)

For Triac dimming LED lighting application, a single stage PFC converter needs large output capacitor to reduce the ripple whose frequency is double of the Grid. And in deep dimming situation, the LED would shimmer caused by the dimming on duty which is not all the same in every line cycle. What's more, the Grid has noise or inrush which would bring out shimmer even flicker. Figure 6 shows a ripple suppressor, which can shrink the LED current ripple obviously.

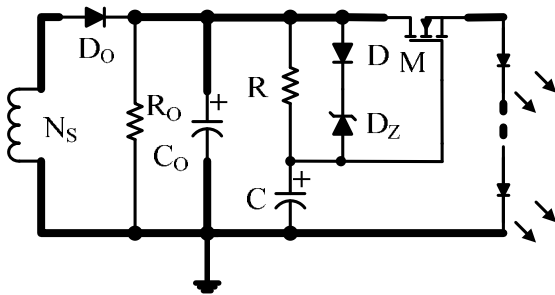

Figure 6: Ripple Suppressor

#### Principle:

Shown in Figure 6, Resistor R, capacitor C, and MOSFET M compose the ripple suppressor. Through the RC filter, C gets the mean value of the output voltage  $V_{Co}$  to drive the MOSFET M. M works in variable resistance area. C's voltage  $V_C$  is steady makes the LEDs voltage is steady, so the LEDs current will be smooth. MOSFET M holds the ripple voltage  $v_{Co}$  of the output.

Diode D and Zener diode  $D_Z$  are used to restrain the overshoot at start-up. In the start-up process, through D and  $D_Z$ , C is charged up quickly to turn on M, so the LED current can be built quickly. When  $V_C$  rising up to about the steady value, D and  $D_Z$  turn off, and C combines R as the filter to get the mean voltage drop of  $V_{Co}$ .

The most important parameter of MOSFET M is the threshold voltage  $V_{th}$  which decides the power loss of the ripple suppressor. Lower  $V_{th}$  is better if the MOSFET can work in variable resistance area. The BV of the MOSFET can be selected as double as  $V_{Co}$  and the Continues

Drain current level can be selected as decuple as the LEDs' current at least.

About the RC filter, it can be selected by  $\tau_{RC} \geq 50/f_{LineCycle}$ . Diode D can select 1N4148, and the Zener voltage of  $D_Z$  is as small as possible when guarantee  $V_D + V_{DZ} > 0.5 \cdot V_{Co\_PP}$ .

#### Optional Protection Circuit

In large output voltage or large LEDs current application, MOSFET M may be destroyed by over-voltage or over-current when LED+ shorted to LED- at working.

#### Gate-Source (GS) Over-voltage Protection:

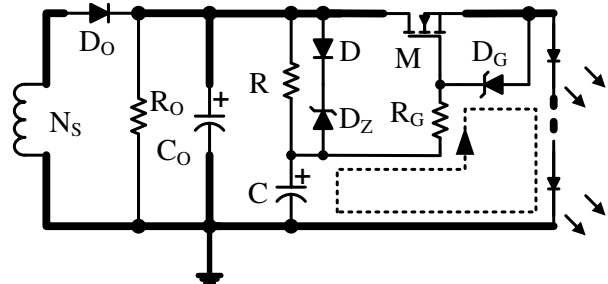

Figure 7: Gate-Source OVP Circuit

Figure 7 shows GS over-voltage protection circuit. Zener diode  $D_G$  and resistor  $R_G$  are used to protect MOSFET M from GS over-voltage damaged. When LED+ shorted to LED- at normal operation, the voltage drop on capacitor C is high, and the voltage drop on Gate-Source is the same as capacitor C. The Zener diode  $D_G$  limits the voltage  $V_{GS}$  and  $R_G$  limits the charging current to protect  $D_G$ .  $R_G$  also can limit the current of  $D_Z$  at the moment when LED+ shorted to LED-.  $V_{DG}$  should bigger than  $V_{th}$ .

#### Drain-Source Over-voltage and Over-current Protection

As Figure 8 shows, NPN transistor T, resistor  $R_C$  and  $R_E$  are set up to protect MOSFET M from over-current damaged when output short occurs at normal operation. When LED+ shorted to LED-, the voltage  $v_{DS}$  of MOSFET is equal to the  $v_{Co}$  which has a high surge caused by the parasitic parameter. Zener Diode  $D_{DS}$  protects MOSFET

from over-voltage damaged. Transistor T is used to pull down the  $V_{GS}$  of M. When M turns off, the load is opened, MP4031 detects there is an OVP happened, so the IC functions in quiescent. The pull down point is set by  $R_C$  and  $R_E$ :

$$R_C/R_E \cdot \frac{V_{CO}}{2} = 0.7V.$$

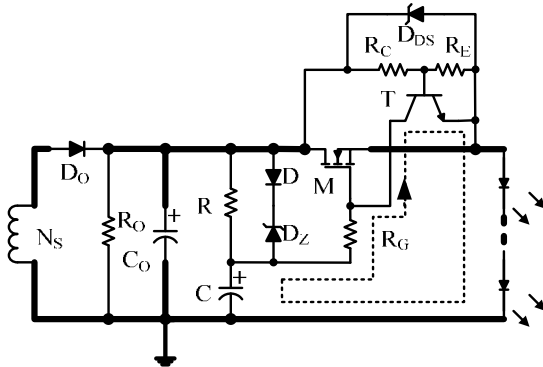

**Figure 8: Drain-Source OVP and OCP Circuit**

### MOSFET LIST

In the Table 1, there are some recommended MOSFET for ripple suppressor.

**Table 1: MOSFET LIST**

Manufacture P/N	Manufacture	$V_{DS}/I_D$	$V_{th}(V_{DS}=V_{GS}@T_J=25^\circ C)$	Power Stage
Si4446DY	Vishay	40V/3A	0.6-1.6V@ $I_D=250\mu A$	<10W
FTD100N10A	IPS	100V/17A	1.0-2.0V@ $I_D=250\mu A$	5-15W
P6015CDG	NIKO-SEM	150V/20A	0.45-1.20V@ $I_D=250\mu A$	10-20W

**NOTICE:** The information in this document is subject to change without notice. Please contact MPS for current specifications. Users should warrant and guarantee that third party Intellectual Property rights are not infringed upon when integrating MPS products into any application. MPS will not assume any legal responsibility for any said applications.