

2-928247-5 ✓ ACTIVE

RAST | RAST 5 IDC Connectors

TE Internal #: 2-928247-5

Housing, Receptacle, Wire-to-Board, 5 Position, .197 in [5 mm]

Centerline, Crimp, 1 Row, Black, Mating Retention, Wire & Cable,

RAST 5 IDC Connectors

[View on TE.com >](#)



Connectors > PCB Connectors > Wire-to-Board Connectors > Wire-to-Board Connector Assemblies & Housings

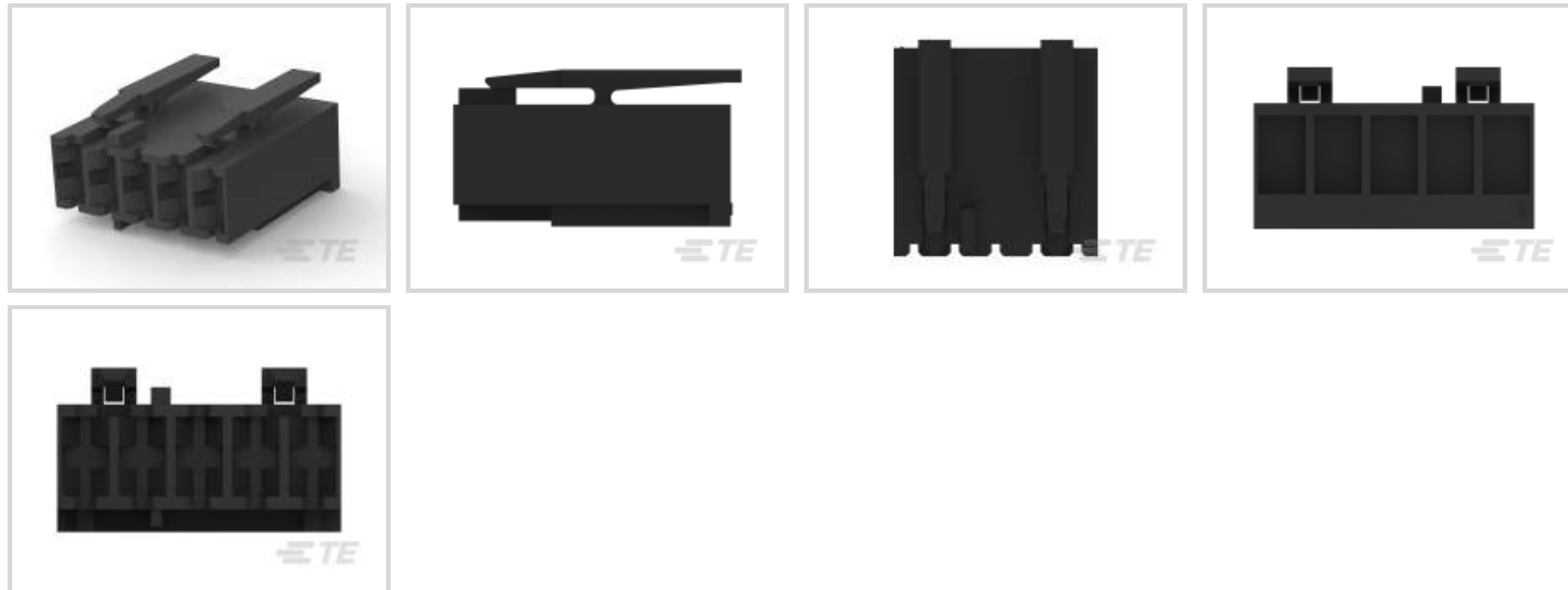

Connector Product Type: **Housing**

Connector & Housing Type: **Receptacle**

Connector System: **Wire-to-Board**

Number of Positions: **5**

Centerline (Pitch): **5 mm [ .197 in ]**

## Features

### Product Type Features

Connector Product Type	Housing
Connector & Housing Type	Receptacle
Connector System	Wire-to-Board
Sealable	No
Connector & Contact Terminates To	Wire & Cable

### Configuration Features

Keying & Polarized Rib Location	2b
Number of Positions	5
Number of Rows	1

### Body Features

Primary Product Color	Black
-----------------------	-------

### Termination Features

Termination Method to Wire & Cable	Crimp
------------------------------------	-------

### Mechanical Attachment

Locking Latch Between Cavity Number	1&2/4&5
Strain Relief	Without
Panel Mount Feature	Without
PCB Mount Retention	Without
Mating Retention Type	Latch
Mating Retention	With
Connector Mounting Type	Cable Mount (Free-Hanging)

### Housing Features

Housing Material	Nylon
Centerline (Pitch)	5 mm [.197 in]

### Dimensions

Connector Length	25 mm [.984 in]
Connector Height	14.4 mm [.567 in]

### Usage Conditions

Operating Temperature Range	-40 – 110 °C [-40 – 230 °F]
-----------------------------	-----------------------------

### Operation/Application

Circuit Application	Power & Signal
---------------------	----------------

### Industry Standards

RAST Version	05-B
Glow Wire Rating	Glow Wire
UL Flammability Rating	UL 94V-2

### Packaging Features

Packaging Quantity	2000
Packaging Method	Bag

### Product Compliance

[For compliance documentation, visit the product page on TE.com>](#)

EU RoHS Directive 2011/65/EU	Compliant
EU ELV Directive 2000/53/EC	Compliant
China RoHS 2 Directive MIIT Order No 32, 2016	No Restricted Materials Above Threshold
EU REACH Regulation (EC) No. 1907/2006	



Current ECHA Candidate List: JUNE 2023  
(235)

Candidate List Declared Against: JAN 2023  
(233)

Does not contain REACH SVHC

Halogen Content

Low Halogen - Br, Cl, F, I < 900 ppm per homogenous material. Also BFR/CFR/PVC Free

Solder Process Capability

Not applicable for solder process capability

Product Compliance Disclaimer

This information is provided based on reasonable inquiry of our suppliers and represents our current actual knowledge based on the information they provided. This information is subject to change. The part numbers that TE has identified as EU RoHS compliant have a maximum concentration of 0.1% by weight in homogenous materials for lead, hexavalent chromium, mercury, PBB, PBDE, DBP, BBP, DEHP, DIBP, and 0.01% for cadmium, or qualify for an exemption to these limits as defined in the Annexes of Directive 2011/65/EU (RoHS2). Finished electrical and electronic equipment products will be CE marked as required by Directive 2011/65/EU. Components may not be CE marked. Additionally, the part numbers that TE has identified as EU ELV compliant have a maximum concentration of 0.1% by weight in homogenous materials for lead, hexavalent chromium, and mercury, and 0.01% for cadmium, or qualify for an exemption to these limits as defined in the Annexes of Directive 2000/53/EC (ELV). Regarding the REACH Regulation, the information TE provides on SVHC in articles for this part number is based on the latest European Chemicals Agency (ECHA) 'Guidance on requirements for substances in articles' posted at this URL: <https://echa.europa.eu/guidance-documents/guidance-on-reach>

## Compatible Parts



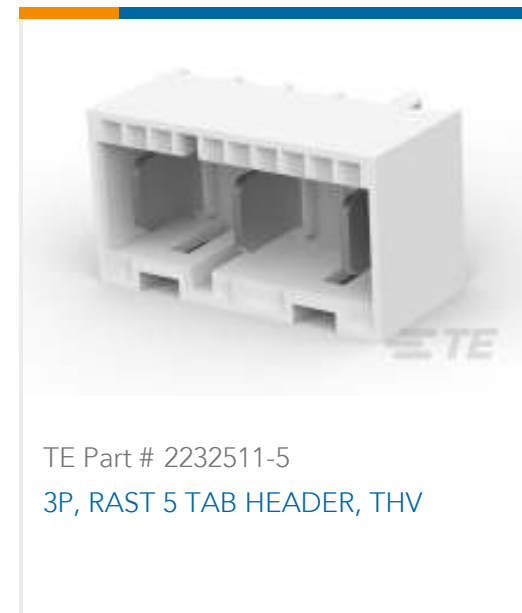

## Also in the Series | RAST 5 IDC Connectors

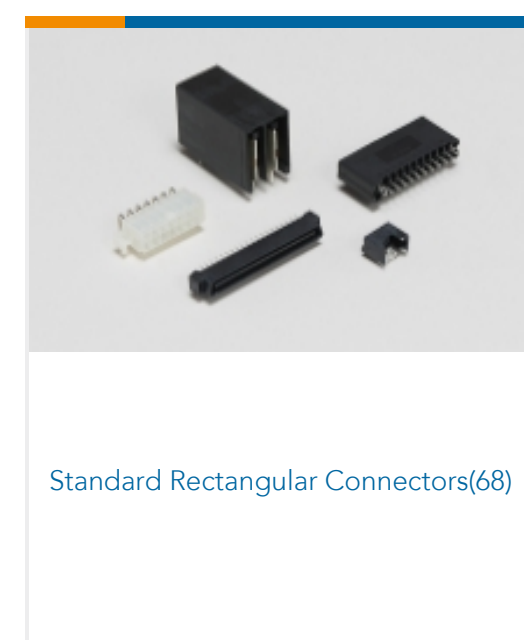
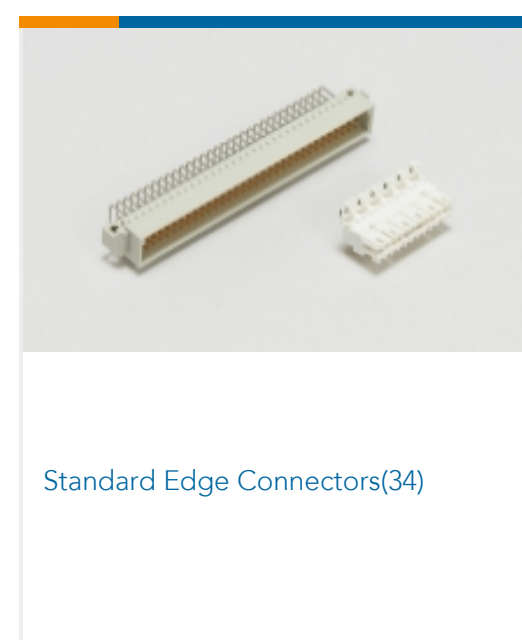
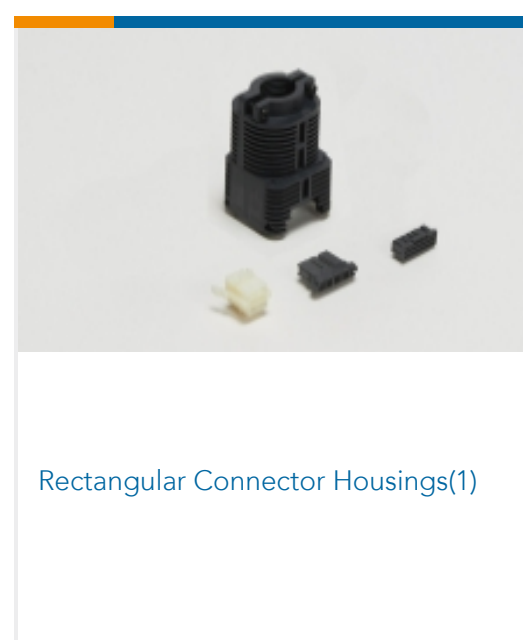
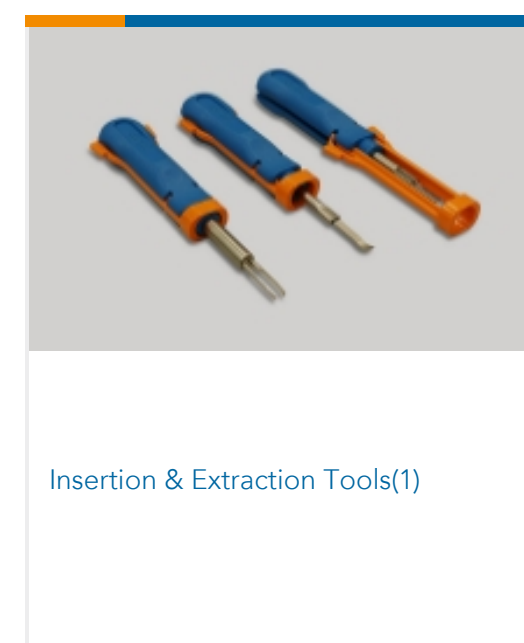
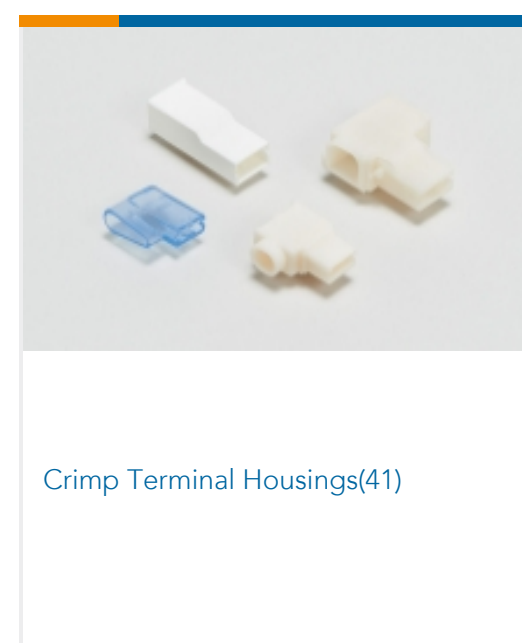
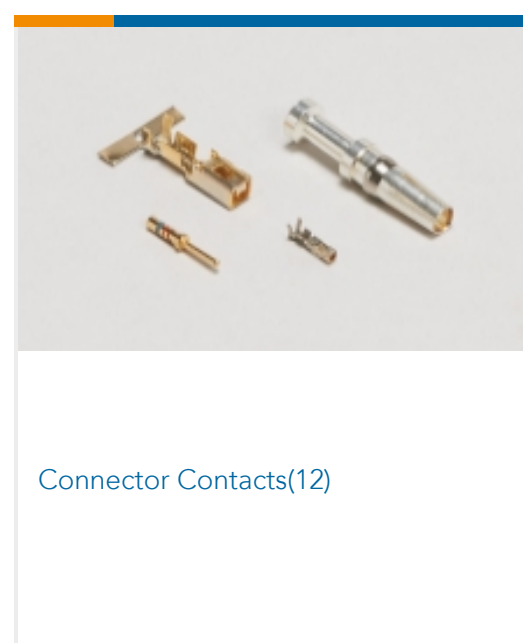
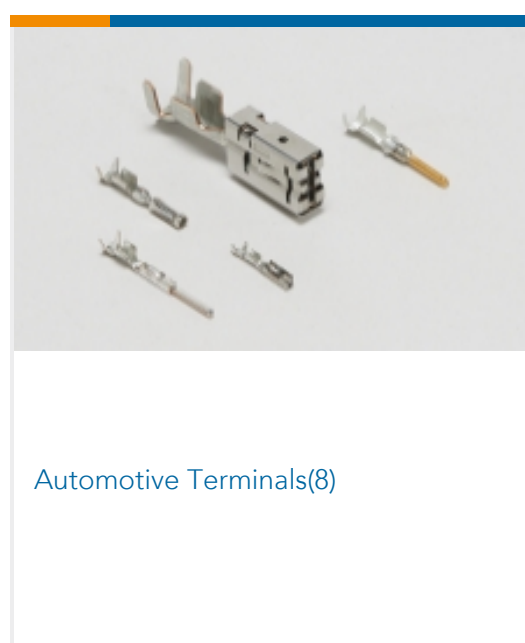



Wire-to-Board Connector Assemblies & Housings(214)



Wire-to-Board Connector Contacts(2)

## Customers Also Bought

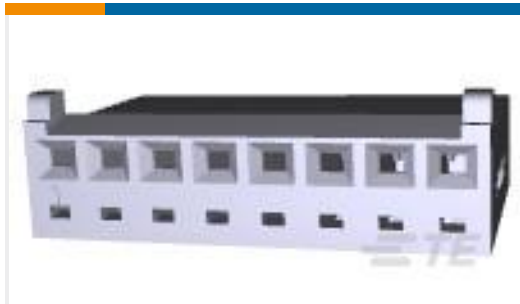

TE Part #1375820-8  
CST-100 II HOUSING 8 POS



TE Part #66261-1  
MALE CONTACT ASSY. (L.P.)



TE Part #647879-1  
SERIES 50&75 CONTACT,10-12 AWG

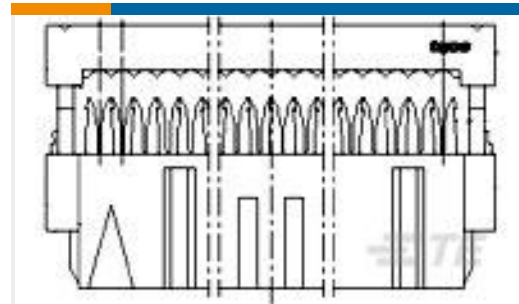

TE Part #1-215882-6  
16 WAY GREY MK II RECP



TE Part #964204-1  
STD-POW-TIM KONTAKT



TE Part #63854-2  
250 PL MKIII REC. 18-14AWG TPBR



TE Part #66740-7  
TYPE XII FEMALE CONT (STRIP)

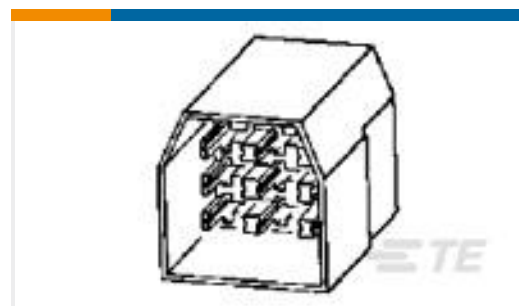

TE Part #151326-1  
FF 250 TAB HSG 11P NYLON NAT



TE Part #346933-000  
2000P-RIBBON-4AG-NAR

## Documents

### Product Drawings

[STD TIMER GEH 5P](#)

English

[STD TIMER GEH 5P](#)

English

### CAD Files

[3D PDF](#)

[3D](#)



**Customer View Model**

[ENG\\_CVM\\_CVM\\_2-928247-5\\_L.2d\\_dxf.zip](#)

English

**Customer View Model**

[ENG\\_CVM\\_CVM\\_2-928247-5\\_L.3d\\_igs.zip](#)

English

**Customer View Model**

[ENG\\_CVM\\_CVM\\_2-928247-5\\_L.3d\\_stp.zip](#)

English

By downloading the CAD file I accept and agree to the [Terms and Conditions](#) of use.

**Datasheets & Catalog Pages**

[1654742\\_HOUSEHOLD\\_APPLIANCES\\_RAST5](#)

English

**Product Environmental Compliance**

[MD\\_2-928247-5\\_061120181133\\_dmtec](#)

English

[MD\\_2-928247-5\\_061120181133\\_dmtec](#)

English

**Agency Approvals**

[VDE Certificate](#)

English

[VDE Certificate](#)

English