

Mechanical Dimensions: Inches [mm]

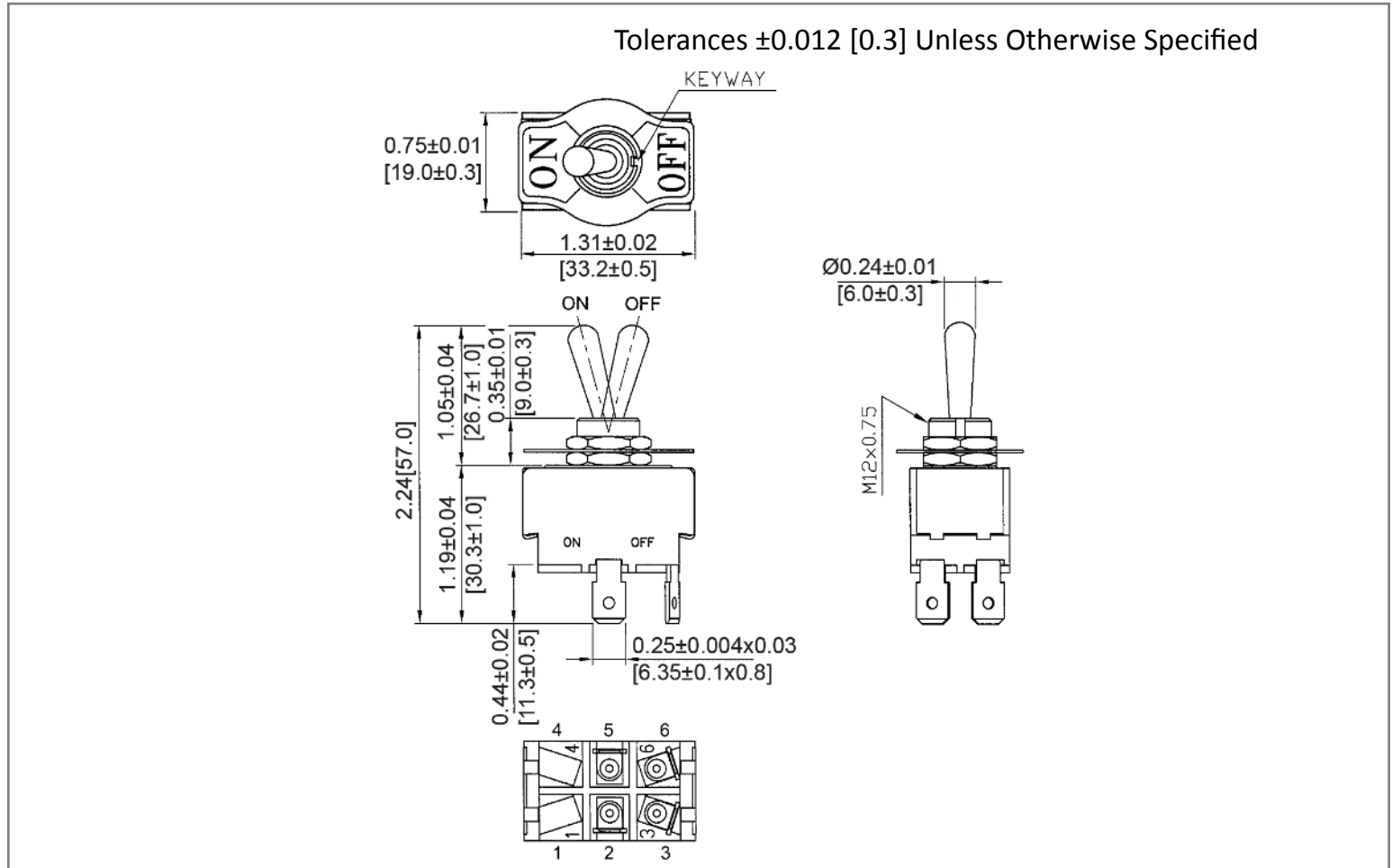

Mounting Hole

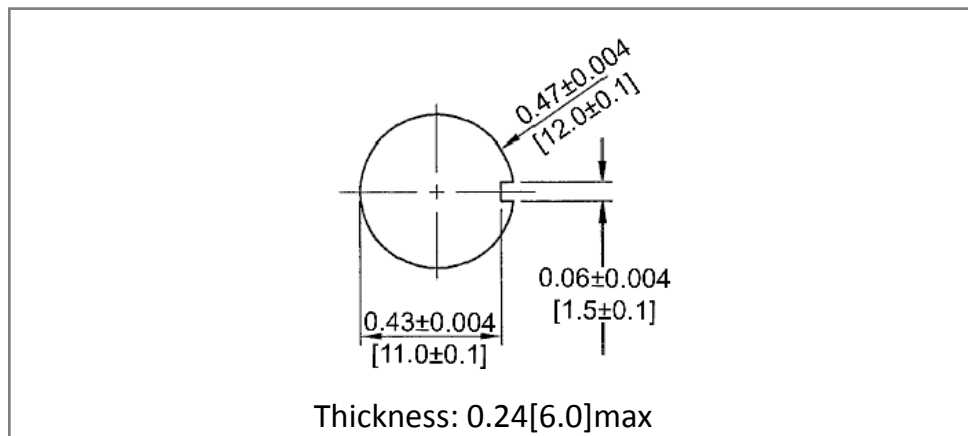

Circuit Diagram

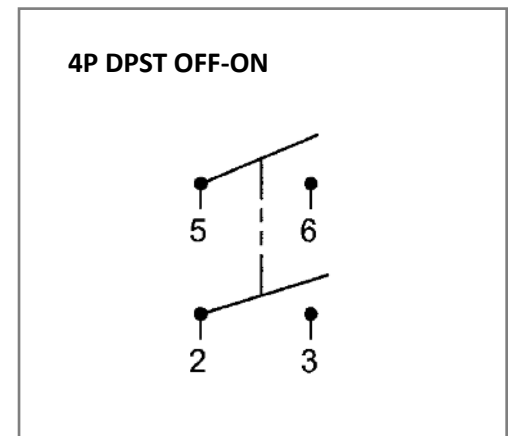

Electrical Specifications

Rating	20A 12V DC, 10A 24V DC
Contact Resistance	50m ohm Max
Insulation Resistance	DC 500V 100M ohm Min
Dielectric Strength	AC 1500V 1 minute
Operation Temperature	0°C~85°C

Material Specifications

2 HEX NUT ASSY
1 ON/OFF FACE PLATE ASSY

Rev	Date of issue	Revision Notes	Designed	Approved
B	07-13-2021	Initial Drawing	RC	OF