

MSOP-8EVM and MSOP-8EVM-PDK

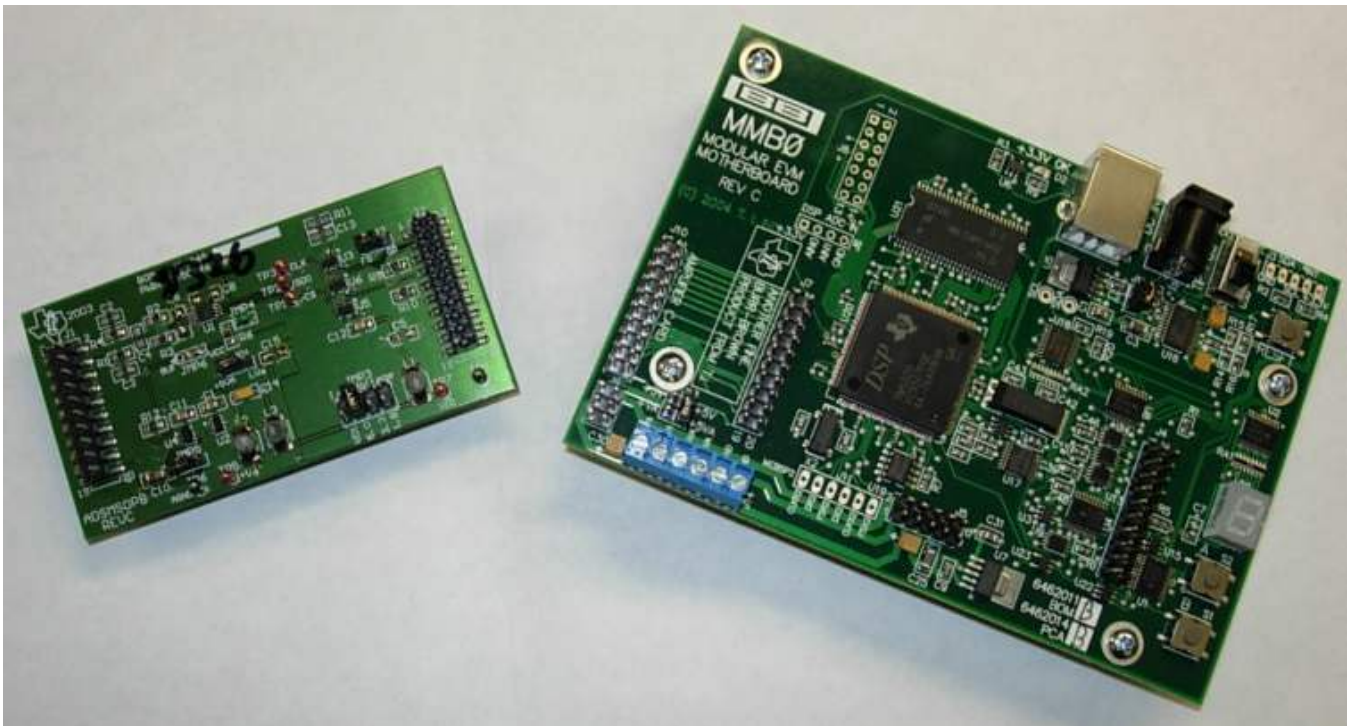

Figure 1. MSOP-8EVM (Left) and MSOP-8EVM-PDK (Right)

This user's guide describes the characteristics, operation, and use of the MSOP-8EVM, both by itself and as part of the MSOP-8EVM-PDK. This EVM is an evaluation board for single-channel, 14- to 16-bit, analog-to-digital converter (ADC) devices in an MSOP-8 package. A complete circuit description, schematic diagram, and bill of materials are included with this document.

This manual covers the operation of both the MSOP-8EVM and the MSOP-8EVM-PDK. It does not describe the MMB0 motherboard in detail. Throughout this document, the abbreviation *EVM* and the term *evaluation module* are synonymous with the MSOP-8EVM.

Contents

1	EVM Overview	3
2	Analog Interface.....	4
3	Digital Interface	4
4	Power Supplies	4
5	EVM Operation.....	7
6	MSOP-8EVM-PDK Kit Operation	8
7	Evaluating with the ADCPro Software.....	18
Appendix A	Bill of Materials (BOM) and Schematic.....	21

List of Figures

1	MSOP-8EVM (Left) and MSOP-8EVM-PDK (Right)	1
2	MMB0 Initial Setup.....	9
3	MSOP-8 EVM Board Initial Setup.....	10
4	Connecting the MSOP-8EVM to the MMB0 Motherboard	10
5	Connecting an AC Adapter	11
6	Laboratory Power-Supply Connection	12
7	ADCPro Software Start-up Display Window	13
8	ADS8326EVM-PDK Plug-In Display Window.....	14
9	Found New Hardware Wizard, Screen 1	15
10	Found New Hardware Wizard, Screen 2.....	15
11	Found New Hardware Wizard, Screen 3	16
12	Found New Hardware Wizard, Screen 4.....	16
13	Found New Hardware Wizard, Screen 5.....	17
14	Continuous Clock—Max SCLK	18
15	Clockstop Mode—Max SCLK.....	19
16	Continuous Mode—Stretched SCLK	19
17	Progress Bar While Collecting Data	20

List of Tables

1	Related Documentation	3
2	J1—Analog Interface Pinout.....	4
3	J2—Digital Interface Pinout	4
4	J3 Pinout	5
5	Jumper Descriptions.....	7
6	Bill of Materials	21

1 EVM Overview

1.1 Features

MSOP-8EVM Features:

- Full-featured evaluation board for a variety of single-channel, 8-pin, micro-SOP, 14- to 16-bit, serial output, ADCs
- Onboard reference and buffer circuits
- High-speed serial interface
- Modular design for use with a variety of DSP and microcontroller interface boards

For use with a computer, the MSOP-8EVM-PDK is available. This kit combines the MSOP-8EVM board with the DSP-based MMB0 motherboard, and includes [ADCPro™ software](#) for evaluation.

The MMB0 motherboard allows the MSOP-8EVM to be connected to the computer via an available USB port. This manual shows how to use the MMB0 as part of the MSOP-8EVM-PDK, but does not provide technical details on the MMB0 itself.

ADCPro is a program for collecting, recording, and analyzing data from ADC evaluation boards. It is based on a number of plug-in programs, so it can be expanded easily with new test and data collection plug-ins. The MSOP-8EVM-PDK is controlled by a plug-in that is executed in ADCPro.

This manual covers the operation of both the MSOP-8EVM and the MSOP-8EVM-PDK. It does not describe the MMB0 motherboard in detail. Throughout this document, the abbreviation *EVM* and the term *evaluation module* are synonymous with the MSOP-8EVM.

1.2 Introduction

The modular MSOP-8 evaluation module is an updated version of the popular Burr-Brown DEM-MSOP-8 evaluation board. The EVM is designed so that a single printed wiring board (PWB) supports a variety of test configurations for high-speed 14- and 16-bit serial ADCs.

The modular EVM form factor allows for direct evaluation of the ADC performance and operating characteristics. This EVM is compatible with the 5-6K Interface Board ([SLAU104](#)), also available from Texas Instruments.

1.3 Related Documentation

[Table 1](#) lists documents related to the MSOP-8EVM. To obtain a copy of any of these TI documents, call the Texas Instruments Literature Response Center at (800) 477-8924 or the Product Information Center (PIC) at (972) 644-5580. When ordering, identify this booklet by its title and literature number. Updated documents can also be obtained through our website at www.ti.com.

Table 1. Related Documentation

EVM-Compatible Device Data Sheets	Literature Number
ADS8320	SBAS108
ADS8321	SBAS123
ADS8324	SBAS172
ADS8325	SBAS226
ADS8326	SBAS343
Application Notes/Additional Literature from TI	Literature Number
Op Amps for Everyone	SLOD006
5-6K Interface Board	SLAU104
Single and Bipolar Signal Conditioning Boards	SLAU105

2 Analog Interface

For maximum flexibility, the modular MSOP-8EVM is designed for easy interfacing to multiple analog sources. Samtec part numbers SSW-110-22-F-D-VS-K and TSM-110-01-T-DV-P provide a convenient, 10-pin, dual-row header/socket combination at J1. This header/socket provides access to the analog input pins of the ADC. Consult Samtec at <http://www.samtec.com> or call 1-800-SAMTEC-9 for a variety of mating connector options.

Table 2. J1—Analog Interface Pinout

Pin Number	Signal	Description
J1.2	AD_IN+	Noninverting input for differential devices, and analog input for single-ended devices
J1.4	AD_IN–	Inverting input for differential devices, and analog ground for single-ended devices
J1.6	Unused	Pins are unused and should be left open for use with future amplifier and sensor input modules
J1.8	Unused	
J1.10	Unused	
J1.12	Unused	
J1.14	Unused	
J1.16	Unused	
J1.18	REF(–)	Unused
J1.20	REF(+)	External reference source input
J1.15	Unused	Unused
J1.1 to J1.19 (odd)	AGND	Analog ground connections (except J1.15)

3 Digital Interface

The modular MSOP-8EVM is designed for easy interfacing to multiple control platforms. Samtec part numbers SSW-110-22-F-D-VS-K and TSM-110-01-T-DV-P provide a convenient, 10-pin, dual-row header/socket combination at J2. This header/socket provides access to the digital control and serial data pins of the MSOP-8EVM. Consult Samtec at <http://www.samtec.com> or 1-800-SAMTEC-9 for a variety of mating connector options.

Table 3. J2—Digital Interface Pinout

Pin Number	Signal Name	Description
J2.1	\overline{CS}	Chip select, active low signal. Enables data transfer, jumper configurable (see the schematic located at the end of this document)
J2.3	SCLK	Serial clock
J2.5	SCLKr	Serial clock return (for DSP host systems)
J2.7	FS	Frame sync for DSP host systems; alternate chip select through JMP2 (see the schematic located at the end of this document)
J2.9	FSr	Frame sync return (for DSP host systems)
J2.11	Unused	Unused
J2.13	SDO	Serial data output
J2.15	Unused	Unused
J2.17	Unused	Unused
J2.19	SPARE	

4 Power Supplies

The modular MSOP-8EVM board requires +5V dc for the analog section. This power source supplies the voltage reference (U2), the reference buffer (U4), and optionally, the ADC installed on the EVM (via JMP1). Supply voltages of +1.8V to +5V dc for the digital section are also required. When used in combination with one of the DAP Interface boards, J3 provides connection to the common power bus described in the 5-6 K Interface Board User's Guide, ([SLAU104](#)). [Table 4](#) shows the pinout for J3.

Table 4. J3 Pinout

Pin Number	Signal	Pin Number	Signal
1	Unused	6	AGND
2	Unused	7	+1.8VD
3	+5VA	8	+VD1
4	Unused	9	+3.3VD
5	DGND	10	+5VD

When power is supplied to J3, JMP3 allows for one of four different dc voltages to be applied to the digital sections of the ADC. Review the schematic (located at the end of this document) and PWB silkscreen (see [Figure 3](#)) for further details.

4.1 **ADC Power**

The device installed on the modular MSOP-8EVM has several options with regard to its power source. Refer to the schematic shown at the end of this document for details about the following information.

JMP1 and JMP3 allow the user to select the power supply used by the ADC. When JMP1 is in the default factory position (shunt on pins 1-2), power to the ADC comes from J3.3 or TP5. Single gate digital buffers (U3, U5, and U6) are installed on the ADC digital input/output lines to allow operation with low-voltage controllers, such as the MSP430. The supply voltage to these buffers is determined by JMP3 or the voltage applied to TP7.

4.2 Standalone Operation

When used as a standalone EVM, the analog power can be applied to TP5 and referenced to TP6. Digital power can be applied to TP7, referenced to TP4. While filters are provided for all power-supply inputs, optimal performance of the EVM requires a clean, well-regulated power source.

CAUTION

The ADCs that are compatible with this EVM have a variety of power-supply requirements. Check the appropriate data sheet and verify that all power supplies are within the safe operating limits of the ADC before applying power to the EVM.

4.3 Reference Voltage

The modular MSOP-8 can be configured to use the onboard reference/buffer circuits (U2 and U4) or an external reference applied to J1.20. Jumpers JMP5 and JMP6 control the reference source. In the factory default position (shunt on JMP5 pins 1-2), a 2.5V reference is supplied by U2. Moving the shunt at JMP5 to positions 2-3 allows an external reference applied to J1.20 to be used.

CAUTION

The ADCs that are compatible with this EVM have a variety of reference requirements. Check the appropriate data sheet and verify that the external reference sources are within the safe operating limits of the ADC before applying power to the EVM.

JMP6 controls the actual application of the reference source to the ADC. In the factory default position (shunt on pins 1-2), the reference source is the onboard reference/buffer circuit. Moving the shunt to JMP6 to pins 2-3 allows the voltage applied to the ADC ($+V_{ADC}$) to be used as the reference source.

5 EVM Operation

This section provides information on the analog input, digital control, and general operating conditions of the MSOP-8EVM.

5.1 Analog Input

The analog input source can be applied directly to J1 (top or bottom side) or through optional amplifier and signal conditioning modules. The analog input range depends on the configuration of the EVM and the ADC installed at location U1. Consult the specific device data sheet to determine the maximum analog input range.

5.2 Digital Control

The digital control signals can be applied directly to J2 (top or bottom side). The modular MSOP-8EVM can also be connected directly to a DSP or microcontroller interface board. Visit the product folder for the MSOP-8EVM or the installed device for a current list of compatible interfaces and/or recommended accessory boards.

5.3 Chip Select (Shutdown)

Jumper JMP2 is provided to allow the selection of the signals applied to the chip select (\overline{CS}) or shutdown (SHDN) pin of the ADC installed on the EVM. The factory default condition for the EVM has a shunt jumper placed between pins 1-2 of JMP2. This configuration allows the Frame Sync (FS) signal from a DSP host system to be used as a chip select for the ADC. This signal originates from J2.7. When JMP2 is moved to pins 2-3, the \overline{CS} (SHDN) signal is applied via J2.1.

5.4 Digital I/O Buffers

Single gate buffers U3, U5, and U6 are provided to ensure the safe operation of the modular MSOP-8EVM with low-voltage host controllers. The digital I/O voltage applied to these buffers via JMP3 should be set in accordance with the operating voltage of the host controller.

5.5 Default Jumper Locations

Table 5 lists the jumpers found on the EVM and the respective factory default condition of each.

Table 5. Jumper Descriptions

Jumper	Shunt Position	Jumper Description
JMP1	Pins 1-2	Controls ADC supply voltage (default is +5V analog source)
JMP2	Pins 1-2	Controls ADC \overline{CS} (SHDN) pin (default is FS from DSP host)
JMP3	Pins 5-6	Controls digital I/O voltage (default is +3.3V digital source)
JMP4	CLOSED	Ties analog and digital grounds together
JMP5	Pins 1-2	Controls external reference source (default is +2.5V from U2)
JMP6	Pins 1-2	Controls reference source to ADC (default is onboard reference/buffer circuit)

6 MSOP-8EVM-PDK Kit Operation

This section provides information on using the MSOP-8EVM-PDK, including setup, program installation, and program usage.

To prepare to evaluate the MSOP-8EVM with the MSOP-8EVM-PDK, complete the following steps:

- Step 1. Install the ADCPro software (if not already installed).
- Step 2. Install the MSOP-8EVM-PDK EVM plug-in software.
- Step 3. Set up the MSOP-8EVM-PDK.
- Step 4. Connect a proper power supply or use the included ac adapter.
- Step 5. Run the ADCPro software.
- Step 6. Complete the Microsoft Windows® USB driver installation process.

Each step is described in the subsequent sections of this document.

6.1 Installing the ADCPro Software

Do not connect the MSOP-8EVM-PDK before installing the software. Failure to observe this procedure may cause Windows to not recognize the MSOP-8EVM-PDK.

The latest software is available from Texas Instruments' website at <http://www.ti.com/>. The CD-ROM shipped with the MSOP-8EVM may not contain the latest software, but the ADCPro installer will check for updates when run, if connected to the Internet, and then give you the option of downloading and installing the latest version. Refer to the [ADCPro User's Guide](#) for instructions on installing and using ADCPro.

To install the MSOP-8EVM-PDK plug-in, run the file: **adsXXXXevm-pdk-plugin-1.0.0.exe** for the installed device (*1.0.0* is the version number, and increments with software version releases; you may have a different version on your CD). Double-click the file to run it; then follow the instructions shown. You can also use the ADCPro *Update Check* feature to check for newer versions of the MSOP-8EVM-PDK plug-in, once you have installed one version of it.

The software should now be installed, but the USB drivers may not yet have been loaded by the PC operating system. This step completes when the ADCPro software is executed; see the section titled [Running the Software and Completing Driver Installation](#).

6.2 Setting Up the MSOP-8EVM-PDK

The MSOP-8EVM-PDK contains both the MSOP-8EVM and the MMB0 motherboard; however, the devices are shipped unconnected. Follow these steps to set up the MSOP-8EVM-PDK:

- Step 1. Unpack the MSOP-8EVM-PDK kit.
- Step 2. Set the jumpers and switches on the MMB0 as shown in [Figure 2](#).
 - (a) Set the Boot Mode switch to USB.
 - (b) Connect +5V and +5VA on jumper block J13 (if +5V is supplied from J14 +5VA).
 - (c) Leave +5V and +VA disconnected on jumper block J13.
 - (d) If the PDK will be powered from an ac adapter, and used in unipolar mode, connect J12. If the PDK will be powered through the terminal block or will be used in bipolar mode, disconnect J12.

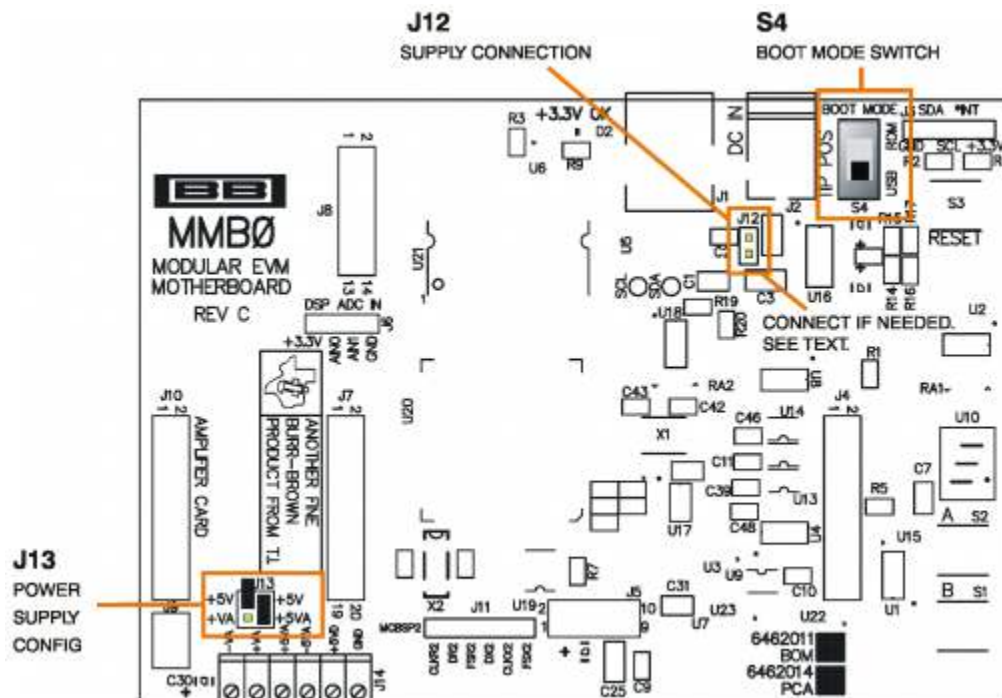

Figure 2. MMB0 Initial Setup

- Step 3. Set the jumpers on the MSOP-8 EVM board as shown in [Figure 3](#) (note that these jumpers are the factory-configured settings for the MSOP-8 EVM):
 - (a) Set I/O Voltage jumper block JMP3 as shown in [Figure 3](#).
 - (b) Set the reference source select jumpers (JMP5 and JMP6) to the onboard/BUF positions.
 - (c) Set the $\overline{CS}/SHDN$ source select jumper (JMP2) to the FS position.
 - (d) Set up VCC jumper block JMP1 as shown in [Figure 3](#).

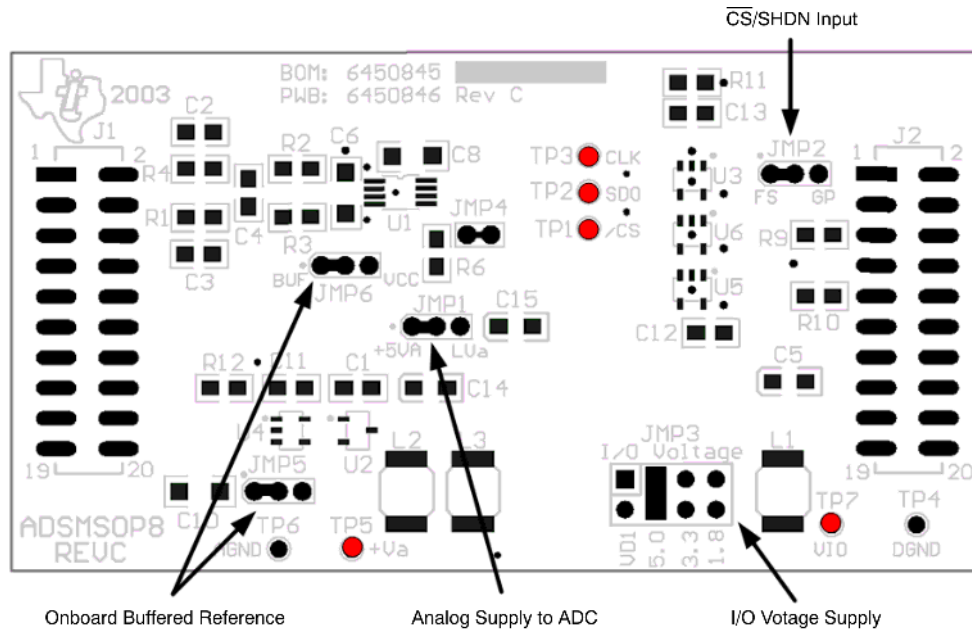

Figure 3. MSOP-8 EVM Board Initial Setup

Step 4. Plug the MSOP-8EVM into the MMB0.



Figure 4. Connecting the MSOP-8EVM to the MMB0 Motherboard

CAUTION

Do not misalign the pins when plugging the MSOP-8EVM into the MMB0. Check the pin alignment of J1, J2 and J3 carefully before applying power to the PDK.

6.2.1 About the MMB0

The MMB0 is a modular EVM system motherboard. It is designed around the [TMS320VC5507](#), a DSP from Texas Instruments that has an onboard USB interface. The MMB0 also has 16MB of SDRAM installed.

The MMB0 is not sold as a DSP development board, and it is not available separately. TI cannot offer support for the MMB0 except as part of an EVM kit. For schematics or other information about the MMB0, contact Texas Instruments.

6.3 Connecting the Power Supply

The MSOP-8EVM-PDK can be operated with a unipolar +5V supply, in which case an external lab power supply can be used via J2 with the included CA-2186 cable or via J14. When the MMB0 DSP is powered properly, LED D2 glows green. The green light indicates that the 3.3V supply for the MMB0 is operating properly; however, it does *not* indicate that the EVM power supplies are operating properly.

6.3.1 Connecting an External Supply

An external supply can be connected to barrel jack J2 on the MMB0 using the included CA-2186 cable. J2 is located next to the USB connector. The adapter must output 6V to 9V dc. The connector must be sleeve-negative, tip-positive. It should have a current rating of at least 500mA. Figure 5 shows the correct connections.

Jumper J12 on the MMB0 connects the external power supply to the board. To use the external power supply, J12 must be shorted.

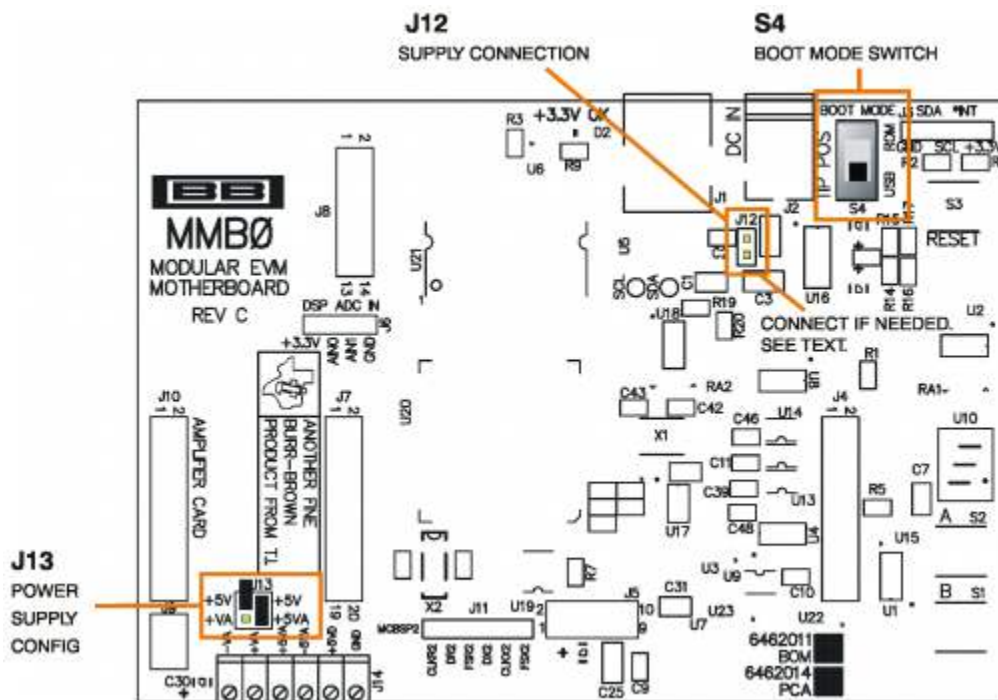

Figure 5. Connecting an AC Adapter

6.3.2 Connecting a Laboratory Power Supply

A laboratory power supply can be connected through terminal block J14 on the MMB0, as shown in Figure 6.

To use a unipolar lab power supply configuration:

- Disconnect J12 on the MMB0.
- Connect a +5V dc supply to the +5VD terminal on J14.
- Connect ground of the dc supply to the GND terminal on J14.

It is not necessary to connect a +5V dc supply voltage to the +5VA terminal on J14 if the +5V/+5VA position on J13 is shorted.

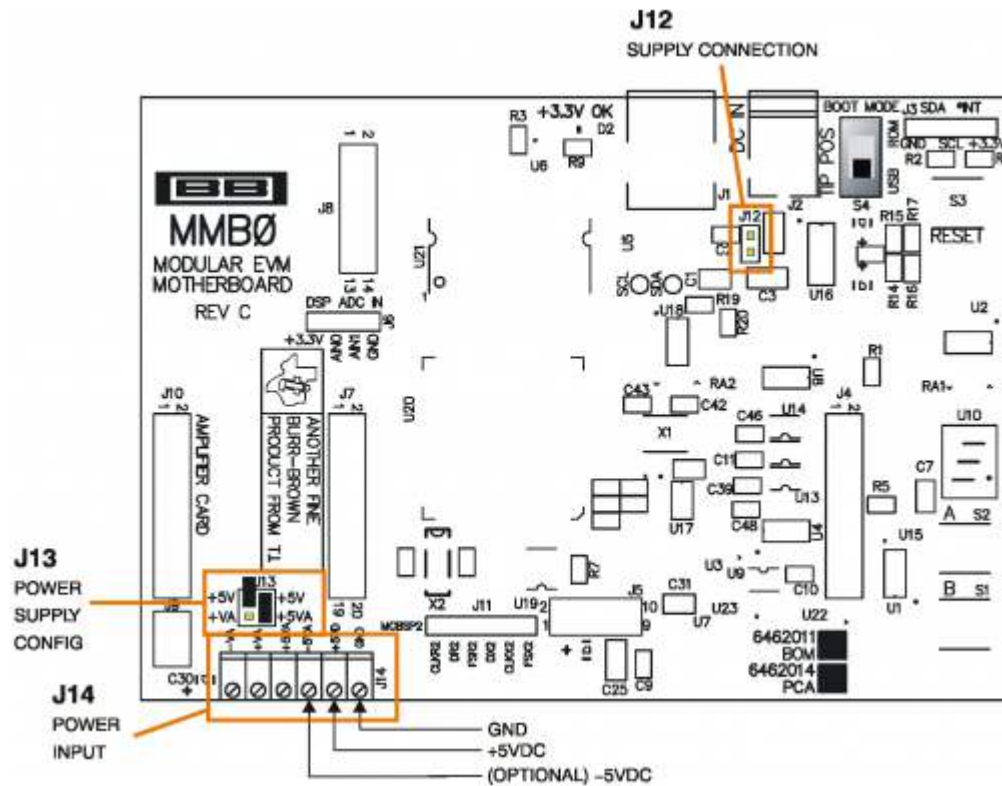

Figure 6. Laboratory Power-Supply Connection

6.4 Running the Software and Completing Driver Installation

NOTE: The software is continually under development. These instructions and screen images are current at the time of this writing, but may not exactly match future releases.

The program for evaluating the MSOP-8EVM-PDK is called ADCPro. This program uses plug-ins to communicate with the EVM. The MSOP-8EVM-PDK plug-in is included in the MSOP-8EVM-PDK package.

The program currently runs only on Windows XP.

Follow these procedures to run ADCPro and complete the necessary driver installation:

- Step 1. Start the software by selecting *ADCPro* from the Windows Start menu. The screenshot shown in [Figure 7](#) appears.

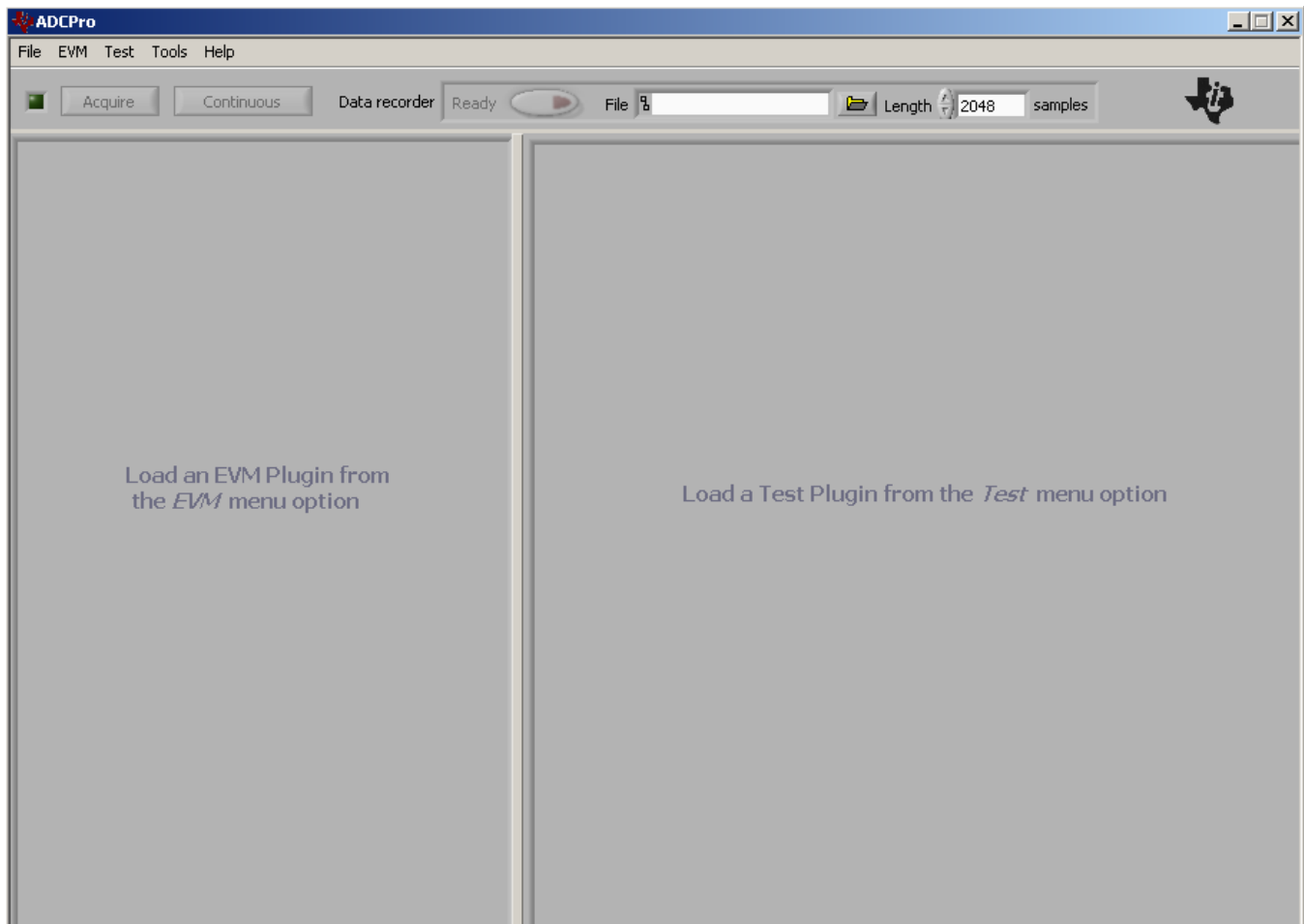

Figure 7. ADCPro Software Start-up Display Window

- Step 2. Select *ADSXXXXEVM* (where *ADSXXXXEVM* is the installed device which is to be evaluated) from the EVM drop-down menu. The *ADSXXXXEVM-PDK* plug-in appears in the left pane, as shown in [Figure 8](#).

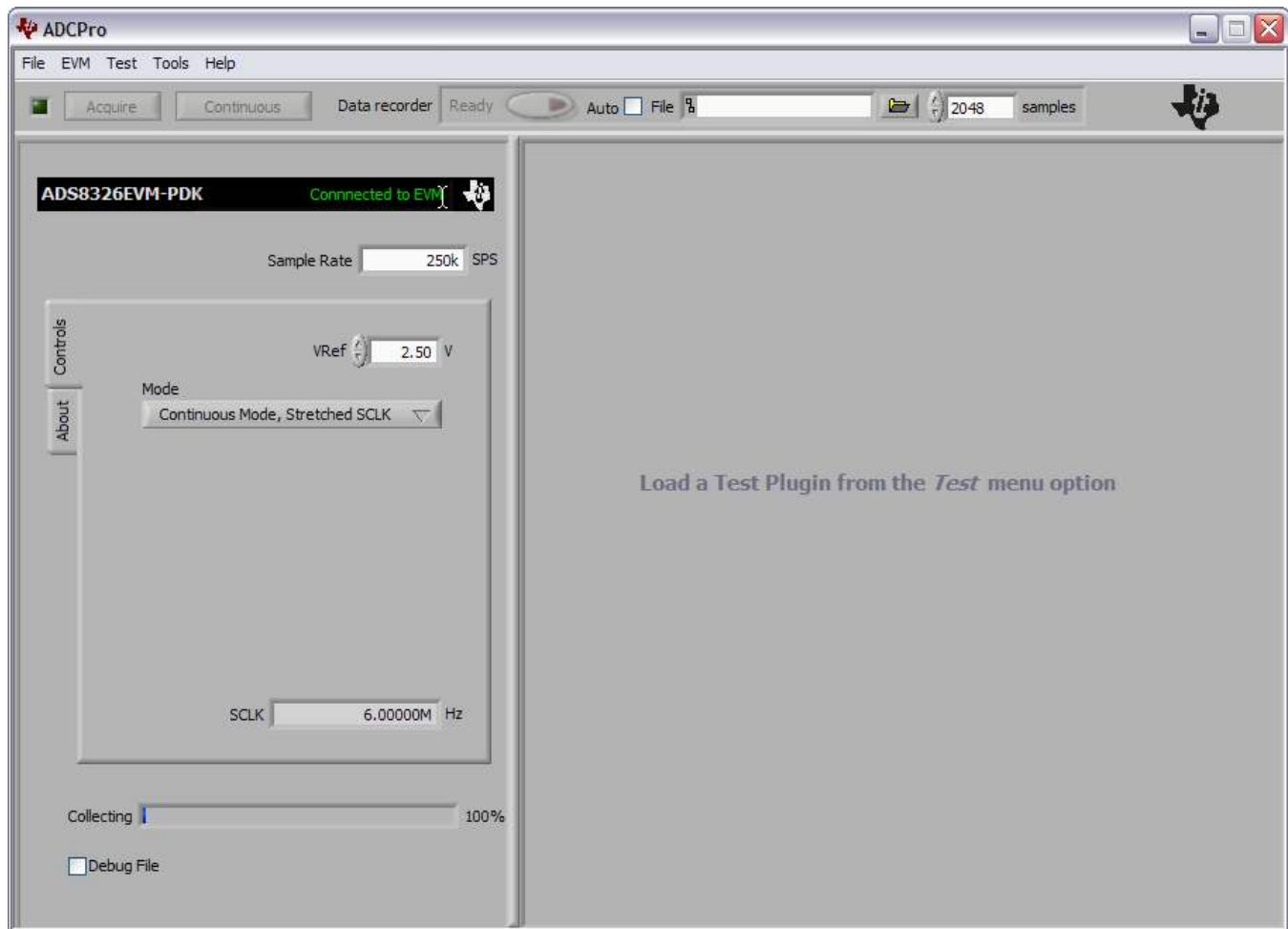

Figure 8. ADS8326EVM-PDK Plug-In Display Window

- Step 3. The MSOP-8EVM-PDK plug-in window has a status area at the top of the screen. When the plug-in is first loaded, the plug-in searches for the board. You will see a series of messages in the status area indicating this action.
- Step 4. Apply power to the PDK and connect the board to an available PC USB port.
- Step 5. If you have not yet loaded the operating system drivers, Windows will display the *Found New Hardware Wizard* sequence (illustrated in [Figure 9](#) through [Figure 13](#)). Accept the default settings.



Figure 9. Found New Hardware Wizard, Screen 1

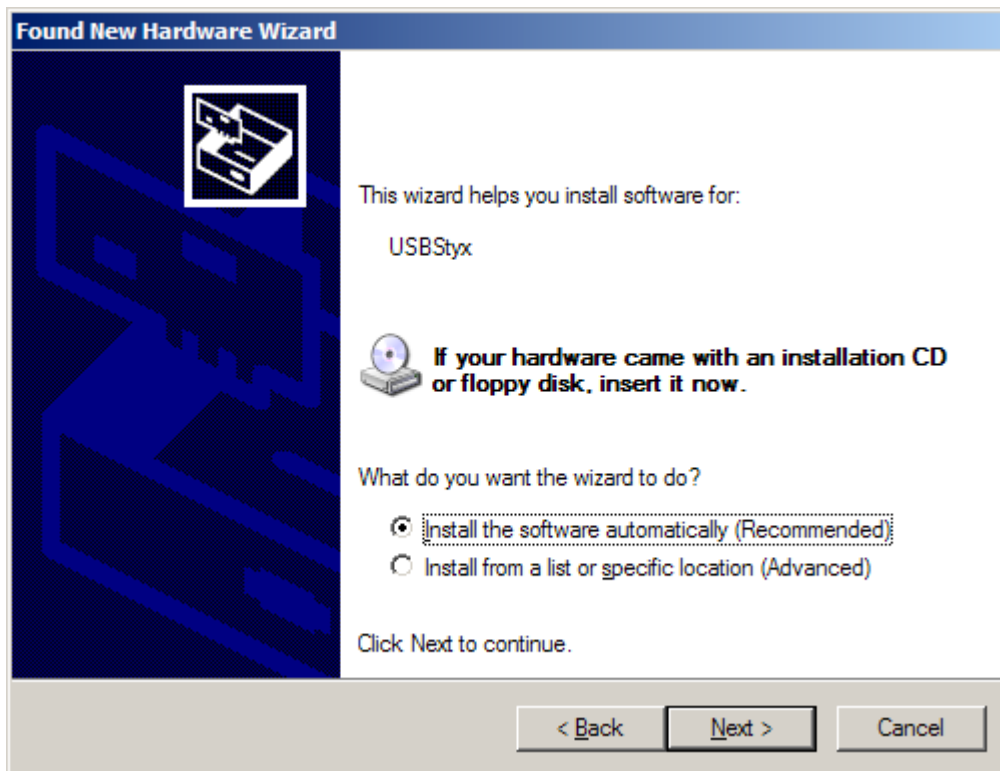

Figure 10. Found New Hardware Wizard, Screen 2

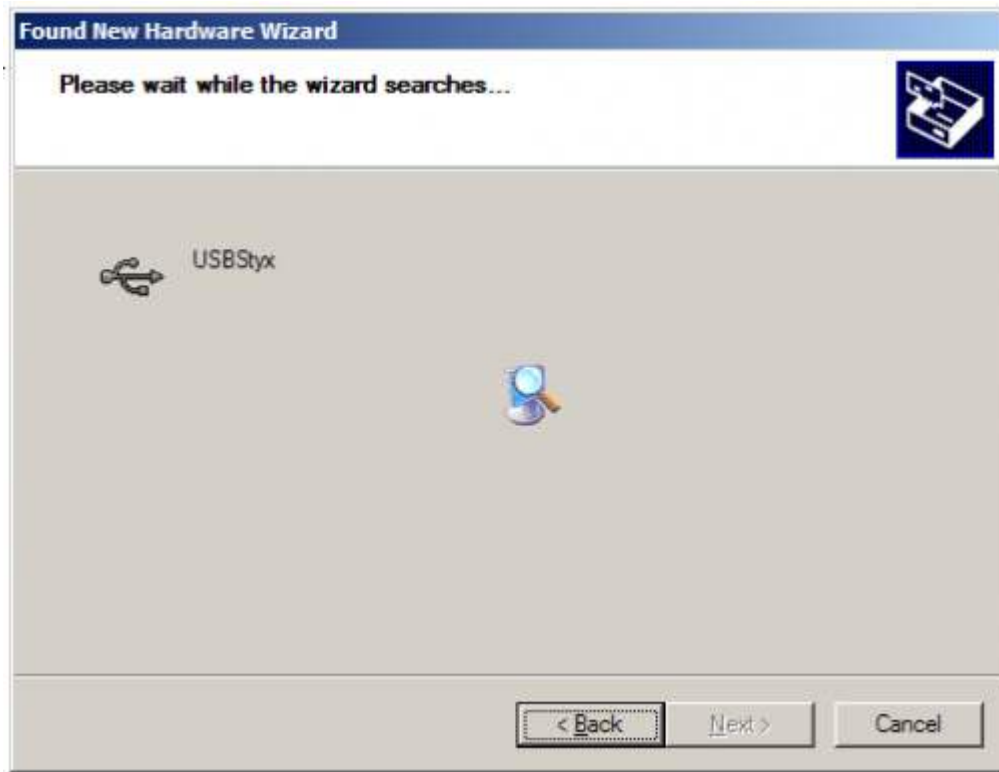

Figure 11. Found New Hardware Wizard, Screen 3

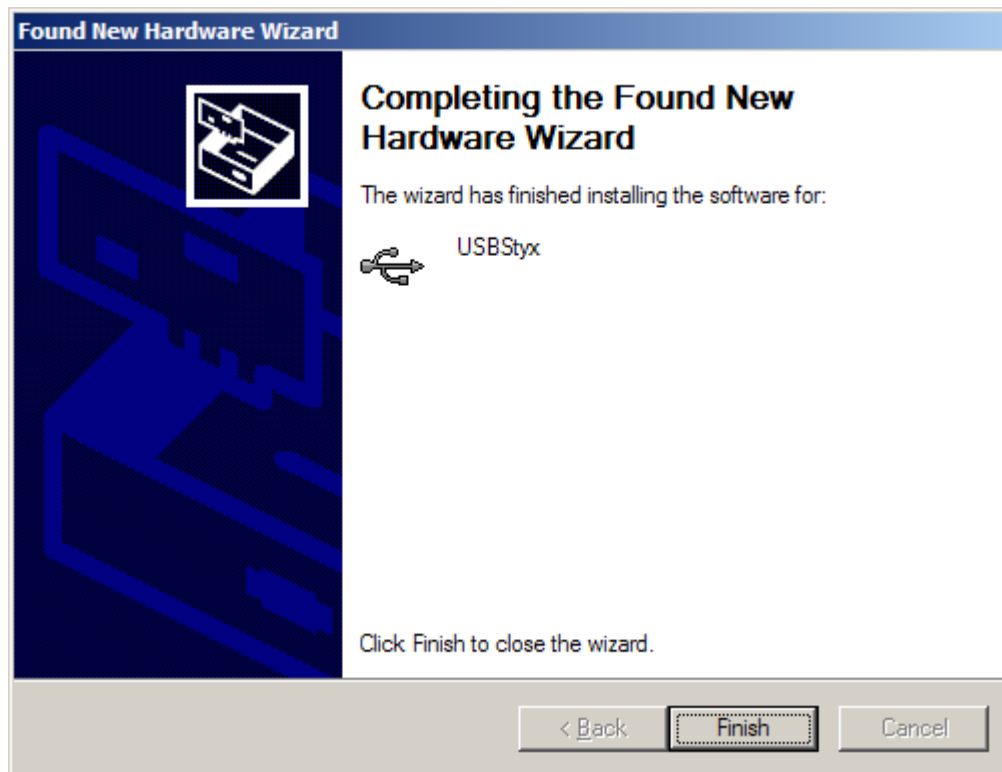

Figure 12. Found New Hardware Wizard, Screen 4

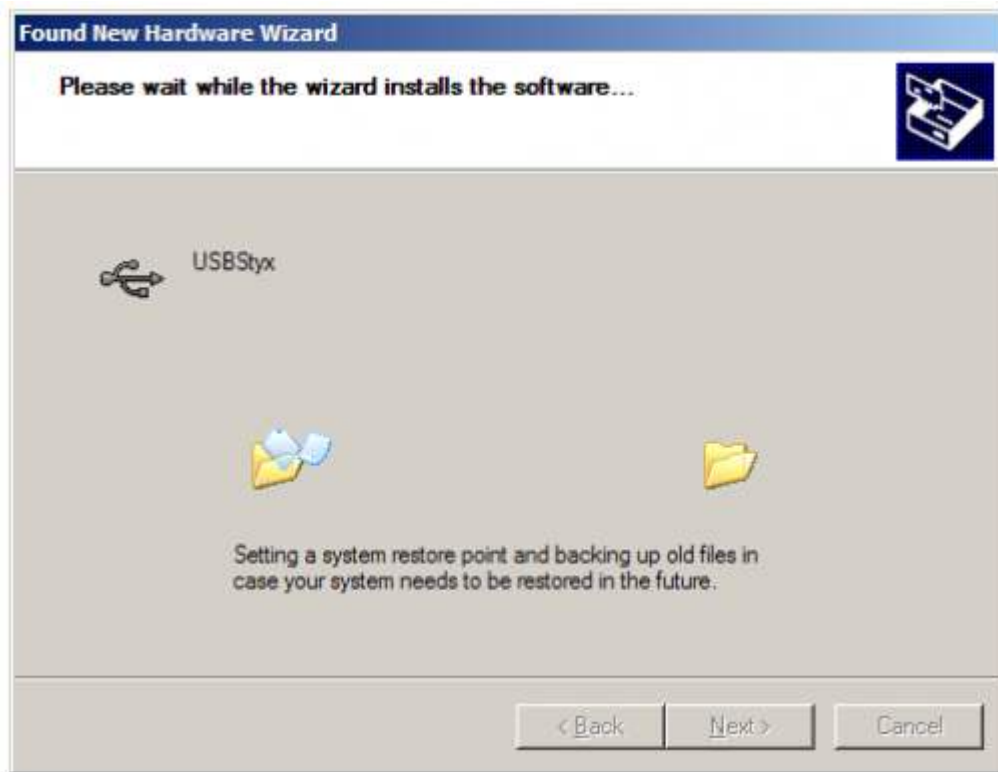

Figure 13. Found New Hardware Wizard, Screen 5

- Step 6. When Windows installs the software driver, the plug-in downloads the firmware to the MMB0.
- Step 7. Windows will display the installation wizard a second time. Again, accept the default settings.
- Step 8. The status area displays a connected message. The software is now ready to use.

The driver installation wizard sequence should not appear again, unless you connect the board to a different USB port.

7 Evaluating with the ADCPro Software

The evaluation software is based on ADCPro, a program that operates using a variety of plug-ins. (The MSOP-8EVM plug-in is installed as described in the installation section.)

To use ADCPro, load an EVM plug-in and a test plug-in. To load an EVM plug-in, select it from the *EVM* menu. To load a test plug-in, select it from the *Test* menu. To unload a plug-in, select the *Unload* option from the corresponding menu.

Only one of each kind of plug-in can be loaded at a time. If you select a different plug-in, the previous plug-in is unloaded.

7.1 Using the MSOP-8EVM-PDK Plug-In

The MSOP-8EVM-PDK plug-ins for ADCPro provide complete control over all settings of the MSOP-8EVM devices. The MSOP-8EVM device settings can be adjusted when not acquiring data. During acquisition, all controls are disabled and settings may not be changed.

When you change a setting on the MSOP-8EVM device plug-in, the setting is immediately updated on the board.

If you unload and reload the plug-in, the software will attempt to load settings from the board.

Settings on the MSOP-8EVM device correspond to the settings described in the particular installed device data sheet. For example, if the installed MSOP-8EVM device is the ADS8326, see the [ADS8326](#) data sheet (available for download at www.ti.com) for details.

The user-configurable settings include *Sample Rate*, *Vref* and *Mode*. The sample rate can only be set up to the maximum stipulated sample rate in the device data sheet (that is, 250kHz for the ADS8326) and *Vref* is specified in the device data sheet (that is, 0.1V to 5V for the ADS8326). The three available clock modes are *Continuous Clock—Max SCLK*, *Clockstop Mode—Max SCLK*, and *Continuous Mode—Stretched SCLK*.

7.1.1 Continuous Clock—Max SCLK

In this mode, SCLK frequency is given as the highest possible serial clock frequency for the data converter under test. The sampling frequency can be adjusted to any desired rate by entering a value in the sampling rate window. The software associated with the MSOP-8 plugin adjusts the number of clock cycles between rising \overline{CS} pulses to accommodate the requested sampling rate while keeping the serial clock speed constant.

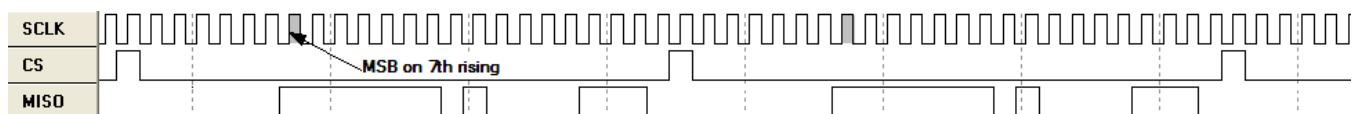

Figure 14. Continuous Clock—Max SCLK

7.1.2 Clockstop Mode—Max SCLK

In this mode, SCLK frequency is also the highest possible serial clock frequency for the data converter under test. The sampling frequency can be adjusted to any desired rate by entering a value in the sampling rate window. The primary difference in this mode of operation is that there are 24 cycles of the serial clock applied to the ADC while the CS input is active. Delay time is added between CS to accommodate the desired sampling rate.

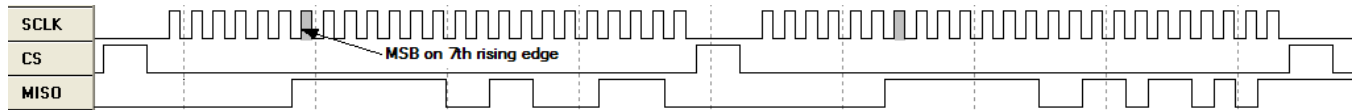

Figure 15. Clockstop Mode—Max SCLK

7.1.3 Continuous Mode—Stretched SCLK

In this mode, SCLK frequency is calculated by the following equation: $SCLK = \text{sampling rate} \times \text{cycles/sample}$. The number of clock cycles per sample period depend on the data converter under test (for the ADS8326, this value is 24). Therefore, with the maximum sampling frequency, $SCLK = 250\text{kHz} \times 24 = 6\text{MHz}$. The number of SCLK cycles applied to the converter is fixed, and the period of the SCLK automatically scales to reach the desired sampling rate for the given device.

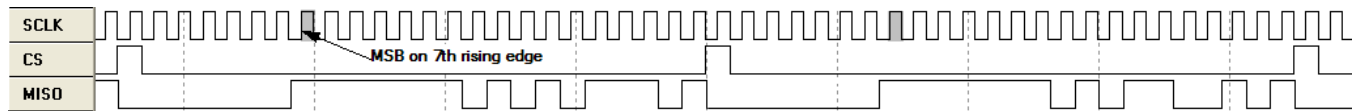

Figure 16. Continuous Mode—Stretched SCLK

7.1.4 Collecting Data

Once you have configured the ADSXXXXEVM device for your test scenario, pressing the ADCPro *Acquire* button starts the collection of the number of data points specified in the Test plug-in *Block Size* control. The ADSXXXXEVM-PDK plug-in disables all the front panel controls while acquiring and displays a progress bar, as shown in [Figure 17](#).

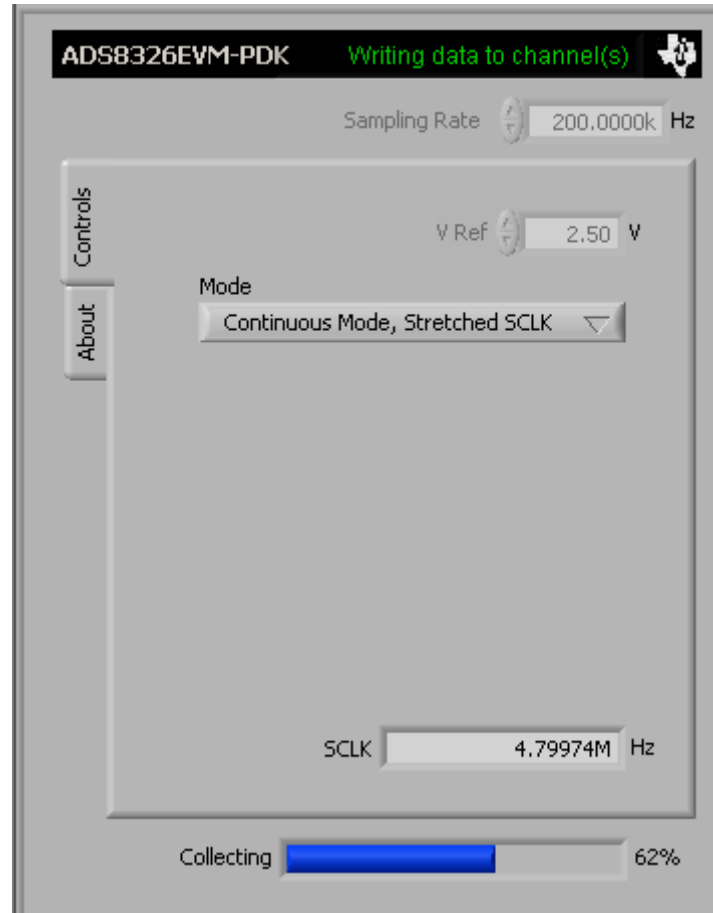

Figure 17. Progress Bar While Collecting Data

For more information on testing ADCs in general and using ADCPro and Test plug-ins, refer to the [ACDPro User's Guide](#).

7.2 Troubleshooting

If ADCPro stops responding while the ADSXXXXEVM-PDK is connected, unplug the power supply from the PDK. Unload and reload the plug-in before reapplying power to the PDK.

Bill of Materials (BOM) and Schematic

Table 6 contains a complete bill of materials for the modular MSOP-8EVM. The schematic diagram is also provided.

Table 6. Bill of Materials

Designators	Description	Manufacturer	Mfg. Part Number
C2, C3, C4, C13	Not Installed		
R11	Not Installed		
C1	0.47 μ F, 0805, Ceramic, X7R, 10%	Panasonic	ECJ-2YB1C474K
C11, C12, C14	0.1 μ F, 0805, Ceramic, X7R, 50V, 10%	Panasonic	ECJ-2YB1H104K
C6, C8, C10	10 μ F, 1206, Ceramic, Y5V, 10V, 10%	Panasonic	ECJ-3YF1A106Z
C5, C14, C15	10 μ F, A Case, Tantalum, 10V	Panasonic	ECS-T1AY106R
L1, L2, L3	15 μ H Inductor, SMT, 1608 Series	Inductors, Inc.	CTDS1608C-153
J1, J2 (top side)	10 Pin, Dual Row, SMT Header (20 Pos.)	Samtec	TSM-110-01-T-DV-P
J1B, J2B (bottom side)	10 Pin, Dual Row, SMT Socket (20 Pos.)	Samtec	SSW-110-22-F-D-VS-K
J3 (bottom side)	5 Pin, Dual Row, SMT Socket (10 Pos.)	Samtec	SSW-105-22-F-D-VS-K
R9, R10	33 Ω , 0805, 5%, 0.1W Resistor	Yageo America	9C08052A33R0JLHFT
R1, R2, R3, R4, R6	0 Ω , 0805, 0.1W Resistor	Yageo America	9C08052A0R00JLHFT
TP1, TP2, TP3, TP5, TP7	Red Test Point Loop	Keystone	5001
TP4, TP6	Black Test Point Loop	Keystone	5000
U1	Varies ⁽¹⁾		
U2	REF3025	TI	REF3025AIDBZT
U3, U5, U6	SN74LVC1G125	TI	SN74LVC1G125DBVT
U4	OPA353N	TI	OPA353NA/250
JMP1, JMP2, JMP5, JMP6	3 Pin , 2mm Header	Samtec	TMMH-103-C-S-T
JMP3	4 Pin, Dual Row, TH Header (8 Pos.)	Samtec	TSW-104-07-L-D

⁽¹⁾ The device installed at location U1 depends on the EVM ordered. This device is soldered to the board for best performance. U1 may be replaced with any device listed in the EVM-compatible device data sheets found in [Table 1](#).

Revision History		
REV	ECN Number	Approved
B	Initial Release	TH

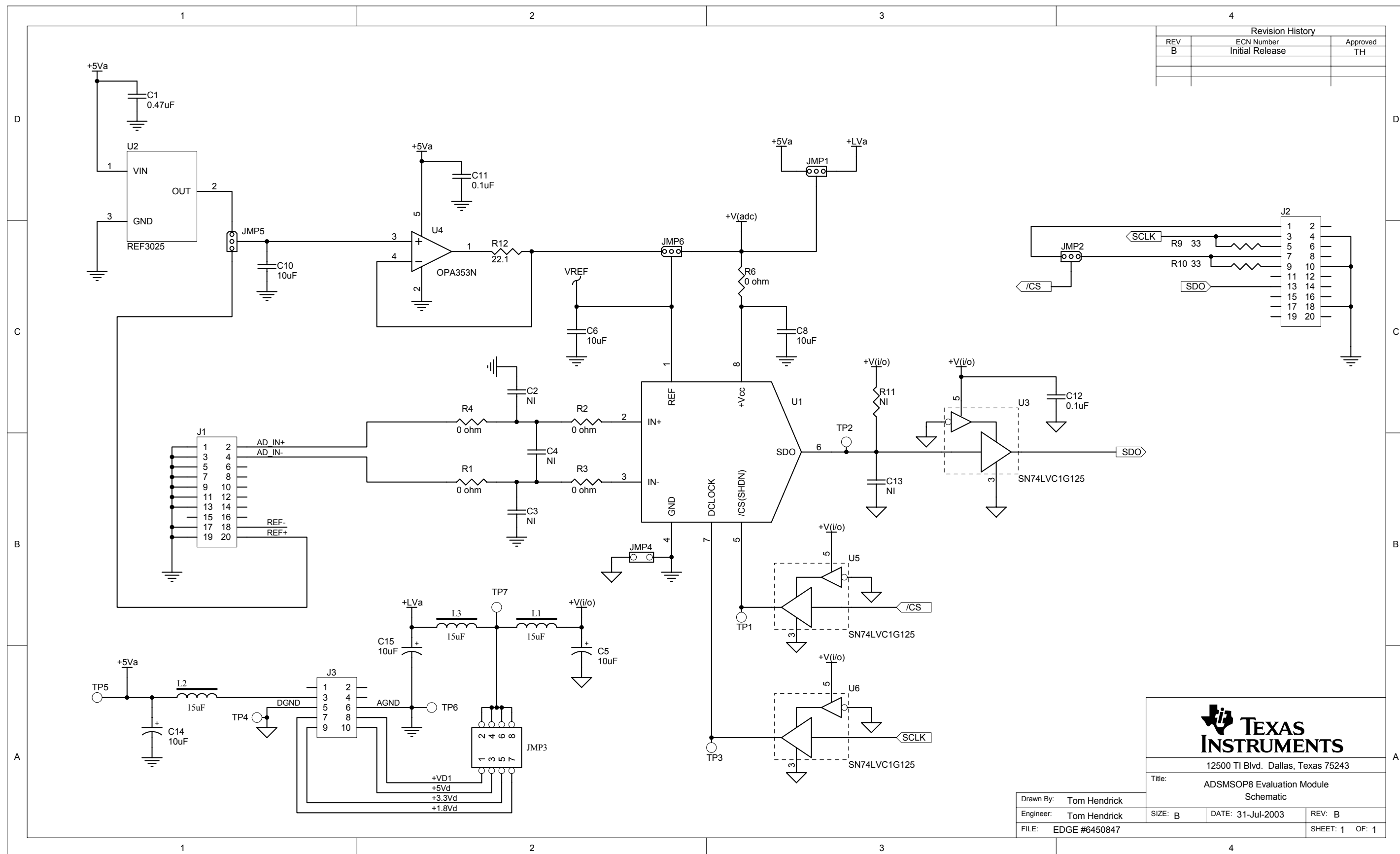

TEXAS INSTRUMENTS
 12500 TI Blvd. Dallas, Texas 75243

Title: **ADSMSOP8 Evaluation Module Schematic**

Drawn By: Tom Hendrick	SIZE: B	DATE: 31-Jul-2003	REV: B
Engineer: Tom Hendrick	FILE: EDGE #6450847	SHEET: 1	OF: 1

Revision History

Changes from Original (December 2008) to A Revision	Page
• Modified the <i>MMB0 Initial Setup</i> image.	9
• Replaced reference of wall supply to external supply in the <i>Connecting the Power Supply</i> section.	11
• Modified the <i>Connecting an AC Adapter</i> image.	11
• Modified <i>Laboratory Power-Supply Connection</i> image.	12

NOTE: Page numbers for previous revisions may differ from page numbers in the current version.

STANDARD TERMS AND CONDITIONS FOR EVALUATION MODULES

1. *Delivery:* TI delivers TI evaluation boards, kits, or modules, including any accompanying demonstration software, components, or documentation (collectively, an "EVM" or "EVMs") to the User ("User") in accordance with the terms and conditions set forth herein. Acceptance of the EVM is expressly subject to the following terms and conditions.
 - 1.1 EVMs are intended solely for product or software developers for use in a research and development setting to facilitate feasibility evaluation, experimentation, or scientific analysis of TI semiconductors products. EVMs have no direct function and are not finished products. EVMs shall not be directly or indirectly assembled as a part or subassembly in any finished product. For clarification, any software or software tools provided with the EVM ("Software") shall not be subject to the terms and conditions set forth herein but rather shall be subject to the applicable terms and conditions that accompany such Software
 - 1.2 EVMs are not intended for consumer or household use. EVMs may not be sold, sublicensed, leased, rented, loaned, assigned, or otherwise distributed for commercial purposes by Users, in whole or in part, or used in any finished product or production system.
2. *Limited Warranty and Related Remedies/Disclaimers:*
 - 2.1 These terms and conditions do not apply to Software. The warranty, if any, for Software is covered in the applicable Software License Agreement.
 - 2.2 TI warrants that the TI EVM will conform to TI's published specifications for ninety (90) days after the date TI delivers such EVM to User. Notwithstanding the foregoing, TI shall not be liable for any defects that are caused by neglect, misuse or mistreatment by an entity other than TI, including improper installation or testing, or for any EVMs that have been altered or modified in any way by an entity other than TI. Moreover, TI shall not be liable for any defects that result from User's design, specifications or instructions for such EVMs. Testing and other quality control techniques are used to the extent TI deems necessary or as mandated by government requirements. TI does not test all parameters of each EVM.
 - 2.3 If any EVM fails to conform to the warranty set forth above, TI's sole liability shall be at its option to repair or replace such EVM, or credit User's account for such EVM. TI's liability under this warranty shall be limited to EVMs that are returned during the warranty period to the address designated by TI and that are determined by TI not to conform to such warranty. If TI elects to repair or replace such EVM, TI shall have a reasonable time to repair such EVM or provide replacements. Repaired EVMs shall be warranted for the remainder of the original warranty period. Replaced EVMs shall be warranted for a new full ninety (90) day warranty period.
3. *Regulatory Notices:*
 - 3.1 *United States*
 - 3.1.1 *Notice applicable to EVMs not FCC-Approved:*

This kit is designed to allow product developers to evaluate electronic components, circuitry, or software associated with the kit to determine whether to incorporate such items in a finished product and software developers to write software applications for use with the end product. This kit is not a finished product and when assembled may not be resold or otherwise marketed unless all required FCC equipment authorizations are first obtained. Operation is subject to the condition that this product not cause harmful interference to licensed radio stations and that this product accept harmful interference. Unless the assembled kit is designed to operate under part 15, part 18 or part 95 of this chapter, the operator of the kit must operate under the authority of an FCC license holder or must secure an experimental authorization under part 5 of this chapter.
 - 3.1.2 *For EVMs annotated as FCC – FEDERAL COMMUNICATIONS COMMISSION Part 15 Compliant:*

CAUTION

This device complies with part 15 of the FCC Rules. Operation is subject to the following two conditions: (1) This device may not cause harmful interference, and (2) this device must accept any interference received, including interference that may cause undesired operation.

Changes or modifications not expressly approved by the party responsible for compliance could void the user's authority to operate the equipment.

FCC Interference Statement for Class A EVM devices

NOTE: This equipment has been tested and found to comply with the limits for a Class A digital device, pursuant to part 15 of the FCC Rules. These limits are designed to provide reasonable protection against harmful interference when the equipment is operated in a commercial environment. This equipment generates, uses, and can radiate radio frequency energy and, if not installed and used in accordance with the instruction manual, may cause harmful interference to radio communications. Operation of this equipment in a residential area is likely to cause harmful interference in which case the user will be required to correct the interference at his own expense.

FCC Interference Statement for Class B EVM devices

NOTE: This equipment has been tested and found to comply with the limits for a Class B digital device, pursuant to part 15 of the FCC Rules. These limits are designed to provide reasonable protection against harmful interference in a residential installation. This equipment generates, uses and can radiate radio frequency energy and, if not installed and used in accordance with the instructions, may cause harmful interference to radio communications. However, there is no guarantee that interference will not occur in a particular installation. If this equipment does cause harmful interference to radio or television reception, which can be determined by turning the equipment off and on, the user is encouraged to try to correct the interference by one or more of the following measures:

- Reorient or relocate the receiving antenna.
- Increase the separation between the equipment and receiver.
- Connect the equipment into an outlet on a circuit different from that to which the receiver is connected.
- Consult the dealer or an experienced radio/TV technician for help.

3.2 Canada

3.2.1 For EVMs issued with an Industry Canada Certificate of Conformance to RSS-210

Concerning EVMs Including Radio Transmitters:

This device complies with Industry Canada license-exempt RSS standard(s). Operation is subject to the following two conditions: (1) this device may not cause interference, and (2) this device must accept any interference, including interference that may cause undesired operation of the device.

Concernant les EVMs avec appareils radio:

Le présent appareil est conforme aux CNR d'Industrie Canada applicables aux appareils radio exempts de licence. L'exploitation est autorisée aux deux conditions suivantes: (1) l'appareil ne doit pas produire de brouillage, et (2) l'utilisateur de l'appareil doit accepter tout brouillage radioélectrique subi, même si le brouillage est susceptible d'en compromettre le fonctionnement.

Concerning EVMs Including Detachable Antennas:

Under Industry Canada regulations, this radio transmitter may only operate using an antenna of a type and maximum (or lesser) gain approved for the transmitter by Industry Canada. To reduce potential radio interference to other users, the antenna type and its gain should be so chosen that the equivalent isotropically radiated power (e.i.r.p.) is not more than that necessary for successful communication. This radio transmitter has been approved by Industry Canada to operate with the antenna types listed in the user guide with the maximum permissible gain and required antenna impedance for each antenna type indicated. Antenna types not included in this list, having a gain greater than the maximum gain indicated for that type, are strictly prohibited for use with this device.

Concernant les EVMs avec antennes détachables

Conformément à la réglementation d'Industrie Canada, le présent émetteur radio peut fonctionner avec une antenne d'un type et d'un gain maximal (ou inférieur) approuvé pour l'émetteur par Industrie Canada. Dans le but de réduire les risques de brouillage radioélectrique à l'intention des autres utilisateurs, il faut choisir le type d'antenne et son gain de sorte que la puissance isotrope rayonnée équivalente (p.i.r.e.) ne dépasse pas l'intensité nécessaire à l'établissement d'une communication satisfaisante. Le présent émetteur radio a été approuvé par Industrie Canada pour fonctionner avec les types d'antenne énumérés dans le manuel d'usage et ayant un gain admissible maximal et l'impédance requise pour chaque type d'antenne. Les types d'antenne non inclus dans cette liste, ou dont le gain est supérieur au gain maximal indiqué, sont strictement interdits pour l'exploitation de l'émetteur.

3.3 Japan

3.3.1 *Notice for EVMs delivered in Japan:* Please see http://www.tij.co.jp/lstds/ti_ja/general/eStore/notice_01.page 日本国内に輸入される評価用キット、ボードについては、次のところをご覧ください。
http://www.tij.co.jp/lstds/ti_ja/general/eStore/notice_01.page

3.3.2 *Notice for Users of EVMs Considered "Radio Frequency Products" in Japan:* EVMs entering Japan may not be certified by TI as conforming to Technical Regulations of Radio Law of Japan.

If User uses EVMs in Japan, not certified to Technical Regulations of Radio Law of Japan, User is required by Radio Law of Japan to follow the instructions below with respect to EVMs:

1. Use EVMs in a shielded room or any other test facility as defined in the notification #173 issued by Ministry of Internal Affairs and Communications on March 28, 2006, based on Sub-section 1.1 of Article 6 of the Ministry's Rule for Enforcement of Radio Law of Japan,
2. Use EVMs only after User obtains the license of Test Radio Station as provided in Radio Law of Japan with respect to EVMs, or
3. Use of EVMs only after User obtains the Technical Regulations Conformity Certification as provided in Radio Law of Japan with respect to EVMs. Also, do not transfer EVMs, unless User gives the same notice above to the transferee. Please note that if User does not follow the instructions above, User will be subject to penalties of Radio Law of Japan.

【無線電波を送信する製品の開発キットをお使いになる際の注意事項】 開発キットの中には技術基準適合証明を受けていないものがあります。技術適合証明を受けていないものご使用に際しては、電波法遵守のため、以下のいずれかの措置を取っていただく必要がありますのでご注意ください。

1. 電波法施行規則第6条第1項第1号に基づく平成18年3月28日総務省告示第173号で定められた電波暗室等の試験設備でご使用いただく。
2. 実験局の免許を取得後ご使用いただく。
3. 技術基準適合証明を取得後ご使用いただく。

なお、本製品は、上記の「ご使用にあたっての注意」を譲渡先、移転先に通知しない限り、譲渡、移転できないものとします。

上記を遵守頂けない場合は、電波法の罰則が適用される可能性があることをご留意ください。日本テキサス・インスツルメンツ株式会社
東京都新宿区西新宿 6 丁目 2 4 番 1 号
西新宿三井ビル

3.3.3 *Notice for EVMs for Power Line Communication:* Please see http://www.tij.co.jp/llds/ti_ja/general/eStore/notice_02.page
電力線搬送波通信についての開発キットをお使いになる際の注意事項については、次のところをご覧ください。http://www.tij.co.jp/llds/ti_ja/general/eStore/notice_02.page

4 *EVM Use Restrictions and Warnings:*

4.1 EVMS ARE NOT FOR USE IN FUNCTIONAL SAFETY AND/OR SAFETY CRITICAL EVALUATIONS, INCLUDING BUT NOT LIMITED TO EVALUATIONS OF LIFE SUPPORT APPLICATIONS.

4.2 User must read and apply the user guide and other available documentation provided by TI regarding the EVM prior to handling or using the EVM, including without limitation any warning or restriction notices. The notices contain important safety information related to, for example, temperatures and voltages.

4.3 *Safety-Related Warnings and Restrictions:*

4.3.1 User shall operate the EVM within TI's recommended specifications and environmental considerations stated in the user guide, other available documentation provided by TI, and any other applicable requirements and employ reasonable and customary safeguards. Exceeding the specified performance ratings and specifications (including but not limited to input and output voltage, current, power, and environmental ranges) for the EVM may cause personal injury or death, or property damage. If there are questions concerning performance ratings and specifications, User should contact a TI field representative prior to connecting interface electronics including input power and intended loads. Any loads applied outside of the specified output range may also result in unintended and/or inaccurate operation and/or possible permanent damage to the EVM and/or interface electronics. Please consult the EVM user guide prior to connecting any load to the EVM output. If there is uncertainty as to the load specification, please contact a TI field representative. During normal operation, even with the inputs and outputs kept within the specified allowable ranges, some circuit components may have elevated case temperatures. These components include but are not limited to linear regulators, switching transistors, pass transistors, current sense resistors, and heat sinks, which can be identified using the information in the associated documentation. When working with the EVM, please be aware that the EVM may become very warm.

4.3.2 EVMs are intended solely for use by technically qualified, professional electronics experts who are familiar with the dangers and application risks associated with handling electrical mechanical components, systems, and subsystems. User assumes all responsibility and liability for proper and safe handling and use of the EVM by User or its employees, affiliates, contractors or designees. User assumes all responsibility and liability to ensure that any interfaces (electronic and/or mechanical) between the EVM and any human body are designed with suitable isolation and means to safely limit accessible leakage currents to minimize the risk of electrical shock hazard. User assumes all responsibility and liability for any improper or unsafe handling or use of the EVM by User or its employees, affiliates, contractors or designees.

4.4 User assumes all responsibility and liability to determine whether the EVM is subject to any applicable international, federal, state, or local laws and regulations related to User's handling and use of the EVM and, if applicable, User assumes all responsibility and liability for compliance in all respects with such laws and regulations. User assumes all responsibility and liability for proper disposal and recycling of the EVM consistent with all applicable international, federal, state, and local requirements.

5. *Accuracy of Information:* To the extent TI provides information on the availability and function of EVMs, TI attempts to be as accurate as possible. However, TI does not warrant the accuracy of EVM descriptions, EVM availability or other information on its websites as accurate, complete, reliable, current, or error-free.

6. *Disclaimers:*
- 6.1 EXCEPT AS SET FORTH ABOVE, EVMS AND ANY WRITTEN DESIGN MATERIALS PROVIDED WITH THE EVM (AND THE DESIGN OF THE EVM ITSELF) ARE PROVIDED "AS IS" AND "WITH ALL FAULTS." TI DISCLAIMS ALL OTHER WARRANTIES, EXPRESS OR IMPLIED, REGARDING SUCH ITEMS, INCLUDING BUT NOT LIMITED TO ANY IMPLIED WARRANTIES OF MERCHANTABILITY OR FITNESS FOR A PARTICULAR PURPOSE OR NON-INFRINGEMENT OF ANY THIRD PARTY PATENTS, COPYRIGHTS, TRADE SECRETS OR OTHER INTELLECTUAL PROPERTY RIGHTS.
- 6.2 EXCEPT FOR THE LIMITED RIGHT TO USE THE EVM SET FORTH HEREIN, NOTHING IN THESE TERMS AND CONDITIONS SHALL BE CONSTRUED AS GRANTING OR CONFERRING ANY RIGHTS BY LICENSE, PATENT, OR ANY OTHER INDUSTRIAL OR INTELLECTUAL PROPERTY RIGHT OF TI, ITS SUPPLIERS/LICENSORS OR ANY OTHER THIRD PARTY, TO USE THE EVM IN ANY FINISHED END-USER OR READY-TO-USE FINAL PRODUCT, OR FOR ANY INVENTION, DISCOVERY OR IMPROVEMENT MADE, CONCEIVED OR ACQUIRED PRIOR TO OR AFTER DELIVERY OF THE EVM.
7. *USER'S INDEMNITY OBLIGATIONS AND REPRESENTATIONS.* USER WILL DEFEND, INDEMNIFY AND HOLD TI, ITS LICENSORS AND THEIR REPRESENTATIVES HARMLESS FROM AND AGAINST ANY AND ALL CLAIMS, DAMAGES, LOSSES, EXPENSES, COSTS AND LIABILITIES (COLLECTIVELY, "CLAIMS") ARISING OUT OF OR IN CONNECTION WITH ANY HANDLING OR USE OF THE EVM THAT IS NOT IN ACCORDANCE WITH THESE TERMS AND CONDITIONS. THIS OBLIGATION SHALL APPLY WHETHER CLAIMS ARISE UNDER STATUTE, REGULATION, OR THE LAW OF TORT, CONTRACT OR ANY OTHER LEGAL THEORY, AND EVEN IF THE EVM FAILS TO PERFORM AS DESCRIBED OR EXPECTED.
8. *Limitations on Damages and Liability:*
- 8.1 *General Limitations.* IN NO EVENT SHALL TI BE LIABLE FOR ANY SPECIAL, COLLATERAL, INDIRECT, PUNITIVE, INCIDENTAL, CONSEQUENTIAL, OR EXEMPLARY DAMAGES IN CONNECTION WITH OR ARISING OUT OF THESE TERMS AND CONDITIONS OR THE USE OF THE EVMS PROVIDED HEREUNDER, REGARDLESS OF WHETHER TI HAS BEEN ADVISED OF THE POSSIBILITY OF SUCH DAMAGES. EXCLUDED DAMAGES INCLUDE, BUT ARE NOT LIMITED TO, COST OF REMOVAL OR REINSTALLATION, ANCILLARY COSTS TO THE PROCUREMENT OF SUBSTITUTE GOODS OR SERVICES, RETESTING, OUTSIDE COMPUTER TIME, LABOR COSTS, LOSS OF GOODWILL, LOSS OF PROFITS, LOSS OF SAVINGS, LOSS OF USE, LOSS OF DATA, OR BUSINESS INTERRUPTION. NO CLAIM, SUIT OR ACTION SHALL BE BROUGHT AGAINST TI MORE THAN ONE YEAR AFTER THE RELATED CAUSE OF ACTION HAS OCCURRED.
- 8.2 *Specific Limitations.* IN NO EVENT SHALL TI'S AGGREGATE LIABILITY FROM ANY WARRANTY OR OTHER OBLIGATION ARISING OUT OF OR IN CONNECTION WITH THESE TERMS AND CONDITIONS, OR ANY USE OF ANY TI EVM PROVIDED HEREUNDER, EXCEED THE TOTAL AMOUNT PAID TO TI FOR THE PARTICULAR UNITS SOLD UNDER THESE TERMS AND CONDITIONS WITH RESPECT TO WHICH LOSSES OR DAMAGES ARE CLAIMED. THE EXISTENCE OF MORE THAN ONE CLAIM AGAINST THE PARTICULAR UNITS SOLD TO USER UNDER THESE TERMS AND CONDITIONS SHALL NOT ENLARGE OR EXTEND THIS LIMIT.
9. *Return Policy.* Except as otherwise provided, TI does not offer any refunds, returns, or exchanges. Furthermore, no return of EVM(s) will be accepted if the package has been opened and no return of the EVM(s) will be accepted if they are damaged or otherwise not in a resalable condition. If User feels it has been incorrectly charged for the EVM(s) it ordered or that delivery violates the applicable order, User should contact TI. All refunds will be made in full within thirty (30) working days from the return of the components(s), excluding any postage or packaging costs.
10. *Governing Law:* These terms and conditions shall be governed by and interpreted in accordance with the laws of the State of Texas, without reference to conflict-of-laws principles. User agrees that non-exclusive jurisdiction for any dispute arising out of or relating to these terms and conditions lies within courts located in the State of Texas and consents to venue in Dallas County, Texas. Notwithstanding the foregoing, any judgment may be enforced in any United States or foreign court, and TI may seek injunctive relief in any United States or foreign court.

Mailing Address: Texas Instruments, Post Office Box 655303, Dallas, Texas 75265
Copyright © 2015, Texas Instruments Incorporated

IMPORTANT NOTICE

Texas Instruments Incorporated and its subsidiaries (TI) reserve the right to make corrections, enhancements, improvements and other changes to its semiconductor products and services per JESD46, latest issue, and to discontinue any product or service per JESD48, latest issue. Buyers should obtain the latest relevant information before placing orders and should verify that such information is current and complete. All semiconductor products (also referred to herein as "components") are sold subject to TI's terms and conditions of sale supplied at the time of order acknowledgment.

TI warrants performance of its components to the specifications applicable at the time of sale, in accordance with the warranty in TI's terms and conditions of sale of semiconductor products. Testing and other quality control techniques are used to the extent TI deems necessary to support this warranty. Except where mandated by applicable law, testing of all parameters of each component is not necessarily performed.

TI assumes no liability for applications assistance or the design of Buyers' products. Buyers are responsible for their products and applications using TI components. To minimize the risks associated with Buyers' products and applications, Buyers should provide adequate design and operating safeguards.

TI does not warrant or represent that any license, either express or implied, is granted under any patent right, copyright, mask work right, or other intellectual property right relating to any combination, machine, or process in which TI components or services are used. Information published by TI regarding third-party products or services does not constitute a license to use such products or services or a warranty or endorsement thereof. Use of such information may require a license from a third party under the patents or other intellectual property of the third party, or a license from TI under the patents or other intellectual property of TI.

Reproduction of significant portions of TI information in TI data books or data sheets is permissible only if reproduction is without alteration and is accompanied by all associated warranties, conditions, limitations, and notices. TI is not responsible or liable for such altered documentation. Information of third parties may be subject to additional restrictions.

Resale of TI components or services with statements different from or beyond the parameters stated by TI for that component or service voids all express and any implied warranties for the associated TI component or service and is an unfair and deceptive business practice. TI is not responsible or liable for any such statements.

Buyer acknowledges and agrees that it is solely responsible for compliance with all legal, regulatory and safety-related requirements concerning its products, and any use of TI components in its applications, notwithstanding any applications-related information or support that may be provided by TI. Buyer represents and agrees that it has all the necessary expertise to create and implement safeguards which anticipate dangerous consequences of failures, monitor failures and their consequences, lessen the likelihood of failures that might cause harm and take appropriate remedial actions. Buyer will fully indemnify TI and its representatives against any damages arising out of the use of any TI components in safety-critical applications.

In some cases, TI components may be promoted specifically to facilitate safety-related applications. With such components, TI's goal is to help enable customers to design and create their own end-product solutions that meet applicable functional safety standards and requirements. Nonetheless, such components are subject to these terms.

No TI components are authorized for use in FDA Class III (or similar life-critical medical equipment) unless authorized officers of the parties have executed a special agreement specifically governing such use.

Only those TI components which TI has specifically designated as military grade or "enhanced plastic" are designed and intended for use in military/aerospace applications or environments. Buyer acknowledges and agrees that any military or aerospace use of TI components which have **not** been so designated is solely at the Buyer's risk, and that Buyer is solely responsible for compliance with all legal and regulatory requirements in connection with such use.

TI has specifically designated certain components as meeting ISO/TS16949 requirements, mainly for automotive use. In any case of use of non-designated products, TI will not be responsible for any failure to meet ISO/TS16949.

Products

Audio	www.ti.com/audio
Amplifiers	amplifier.ti.com
Data Converters	dataconverter.ti.com
DLP® Products	www.dlp.com
DSP	dsp.ti.com
Clocks and Timers	www.ti.com/clocks
Interface	interface.ti.com
Logic	logic.ti.com
Power Mgmt	power.ti.com
Microcontrollers	microcontroller.ti.com
RFID	www.ti-rfid.com
OMAP Applications Processors	www.ti.com/omap
Wireless Connectivity	www.ti.com/wirelessconnectivity

Applications

Automotive and Transportation	www.ti.com/automotive
Communications and Telecom	www.ti.com/communications
Computers and Peripherals	www.ti.com/computers
Consumer Electronics	www.ti.com/consumer-apps
Energy and Lighting	www.ti.com/energy
Industrial	www.ti.com/industrial
Medical	www.ti.com/medical
Security	www.ti.com/security
Space, Avionics and Defense	www.ti.com/space-avionics-defense
Video and Imaging	www.ti.com/video

TI E2E Community

e2e.ti.com