



Equinox analytical balances bring remarkable precision to labs that perform highly detailed testing. The Equinox is ideal for research and quality assurance facilities; science education; precision counting; and production and manufacturing applications needing exceptionally precise results. A color touch screen display provides intuitive operation, with icon-driven menus and readily accessible applications and functions.

Intuitive user interface for professionals; designed for advanced applications



Features

- Large, responsive 5" 800x480 pixel touch-screen display
- Level indicator and adjustable feet ensure proper balance setup for optimum weighing results
- Security slot for optional Kensington-type lock and cable to help prevent theft
- Large, grade 304 stainless steel pan allows swift cleaning
- RS-232 interface is available to provide speedy connection to computers and printers
- USB host for memory card
- Built-in memory for storing products and settings
- External calibration allows for verification and adjustment with weights
- Selectable digital filtering helps minimize effects of vibration and disturbances
- Security password control prevents unauthorized access
- Printouts include date and time for data tracking within Good Laboratory Practices (GLP) guidelines
- Preset tare function speeds the process of repetitive weighing
- Parts counting with freely selectable sample sizes
- Multilingual display permits use in various regions
- Memory accumulation totals results
- Checkweighing with audible alarm
- AC adapter included

Applications

- Weighing
- Parts counting
- Percentage weighing
- Checkweighing
- Dynamic / animal weighing
- Accumulation
- Density determination
- Display hold
- Formulation
- Statistics
- Textile

About ADAM:

For more than 45 years, professionals worldwide have relied on Adam Equipment for an extensive selection of dependable and affordable weighing equipment. Adam provides the right balance of speed, performance and value.

Product Details

Model	EAB 125i	EAB 225i	EAB 124e	EAB 224e	EAB 314e	EAB 124i	EAB 224i	EAB 314i	EAB 414i	EAB 514i
Capacity	62g / 120g	82g / 220g	120g	220g	310g	120g	220g	310g	410g	510g
Readability	0.01mg/ 0.1mg	0.01mg/ 0.1mg	0.0001g	0.0001g	0.0001g	0.0001g	0.0001g	0.0001g	0.0001g	0.0001g
Repeatability (S.D.)	0.03mg/ 0.1mg	0.05mg/ 0.1mg	0.0001g	0.0001g	0.0001g	0.0001g	0.0001g	0.0001g	0.35mg	0.35mg
Linearity (+/-)	0.08mg / 0.2mg	0.1mg / 0.2mg	0.0003g	0.0003g	0.0004g	0.0003g	0.0003g	0.0004g	0.0005g	0.0005g
Minimum Weight (USP, typical)	10mg	10mg	10mg	10mg	10mg	10mg	10mg	10mg	10mg	10mg
Pan Size	3.1" ø / 80mm ø									
Weighing Units	g, mg, ct, GN, lb, oz, dwt, mm, ozt, tl.H, tl.S, tl.T, T, custom unit									
Stabilization Time (sec)	6					4				
Interface	RS-232, USB									
Calibration	Internal automatic calibration			External calibration			Internal automatic calibration			
Display	Touchscreen with 4.9" / 125mm -high digits									
Power Supply	24V 50/60Hz 500mA adapter									
Operating Temperature	10° to 30°C / 50° to 86°F									
Housing	ABS plastic									
Draft Shield	Chamber 7.6"x7.7"x9.1" / 192x195x230mm									
Overall Dim.	8.8"x14.7"x13.3" / 224x374x338mm (wxdxh)									
Net Weight	15.9lb / 7.2kg									

Accessories

Item number	Description
104008036	Anti-vibration table
1060014262	Density kit
3012014259	In-use wet cover
3014011014	RS-232 cable M-F
700100410	ABI-1 Ionizer
1120011156	ATP thermal printer
3126011263	ATP thermal printer paper
3126011281	ATP thermal printer paper (pack of 10)
600002028	AdamDU Data Collection Program
700660290	Calibration certificate
3014013041	Security lock cable

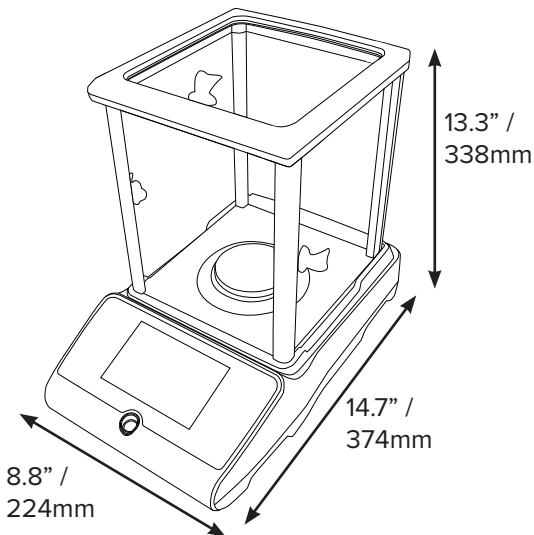

Key Accessories



Anti-vibration table
The AVT anti-vibration table offers a solid, stable surface to help decrease vibration during the operation of analytical or precision balances. The AVT can help reduce fluctuations and inconsistency in measurement resulting from environmental affects.



ATP thermal printer
Easy-to-use features combined with quick set-up equals a truly versatile thermal printer. A single push-button feed key and three easy-to-read LED indicators make operation simple.



AdamDU data collection program
Adam DU software connects a balance to the laboratory network, helping to achieve seamless data collection, transfer and analysis. DU features an easy-to-use interface with a main command window, allowing users to quickly collect information from up to eight Adam balances simultaneously using RS-232 or USB connections.

Supplied by

www.adamequipment.com