



# 2SA2126

## Bipolar Transistor -50V, -3A, Low VCE(sat), PNP Single TP/TP-FA

ON Semiconductor®

http://onsemi.com

### Applications

- DC / DC converter, relay drivers, lamp drivers, motor drivers

### Features

- Adoption of MBIT processes
- Low collector-to-emitter saturation voltage
- High current capacitance
- High-speed switching

### Specifications

Absolute Maximum Ratings at Ta=25°C

Parameter	Symbol	Conditions	Ratings	Unit
Collector-to-Base Voltage	V <sub>CBO</sub>		-50	V
Collector-to-Emitter Voltage	V <sub>CES</sub>		-50	V
Collector-to-Emitter Voltage	V <sub>CEO</sub>		-50	V
Emitter-to-Base Voltage	V <sub>EBO</sub>		-6	V
Collector Current	I <sub>C</sub>		-3	A
Collector Current (Pulse)	I <sub>CP</sub>		-6	A
Base Current	I <sub>B</sub>		-600	mA

Continued on next page.

### Package Dimensions unit : mm (typ) 7518-003

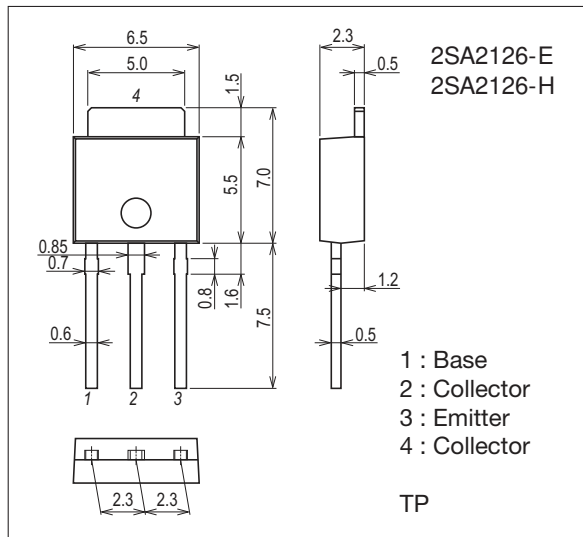

### Package Dimensions unit : mm (typ) 7003-003

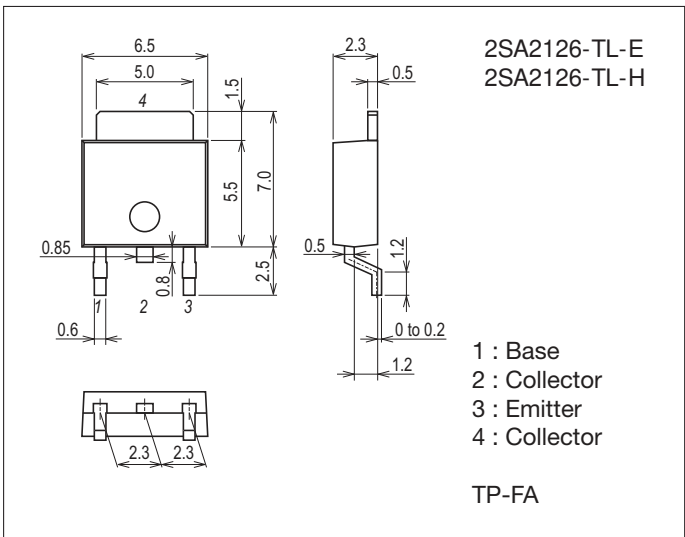

### Product & Package Information

- Package : TP
- JEITA, JEDEC : SC-64, TO-251
- Minimum Packing Quantity : 500 pcs./bag

- Package : TP-FA
- JEITA, JEDEC : SC-63, TO-252
- Minimum Packing Quantity : 700 pcs./reel

### Marking (TP, TP-FA)

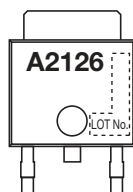

### Packing Type (TP-FA) : TL

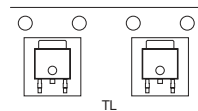

### Electrical Connection

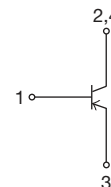

## 2SA2126

Continued from preceding page.

Parameter	Symbol	Conditions	Ratings	Unit
Collector Dissipation	PC		0.8	W
		T <sub>c</sub> =25°C	15	W
Junction Temperature	T <sub>j</sub>		150	°C
Storage Temperature	T <sub>stg</sub>		-55 to +150	°C

Stresses exceeding Maximum Ratings may damage the device. Maximum Ratings are stress ratings only. Functional operation above the Recommended Operating Conditions is not implied. Extended exposure to stresses above the Recommended Operating Conditions may affect device reliability.

### Electrical Characteristics at T<sub>a</sub>=25°C

Parameter	Symbol	Conditions	Ratings			Unit
			min	typ	max	
Collector Cutoff Current	I <sub>CBO</sub>	V <sub>CB</sub> = -40V, I <sub>E</sub> =0A			-1	μA
Emitter Cutoff Current	I <sub>EBO</sub>	V <sub>EB</sub> = -4V, I <sub>C</sub> =0A			-1	μA
DC Current Gain	h <sub>FE</sub>	V <sub>CE</sub> = -2V, I <sub>C</sub> = -100mA	200		560	
Gain-Bandwidth Product	f <sub>T</sub>	V <sub>CE</sub> = -10V, I <sub>C</sub> = -500mA		390		MHz
Output Capacitance	C <sub>ob</sub>	V <sub>CB</sub> = -10V, f=1MHz		24		pF
Collector-to-Emitter Saturation Voltage	V <sub>CE(sat)1</sub>	I <sub>C</sub> = -1A, I <sub>B</sub> = -50mA		-135	-270	mV
	V <sub>CE(sat)2</sub>	I <sub>C</sub> = -2A, I <sub>B</sub> = -100mA		-260	-520	mV
Base-to-Emitter Saturation Voltage	V <sub>BE(sat)</sub>	I <sub>C</sub> = -2A, I <sub>B</sub> = -100mA		-0.96	-1.2	V
Collector-to-Base Breakdown Voltage	V <sub>(BR)CBO</sub>	I <sub>C</sub> = -10μA, I <sub>E</sub> =0A	-50			V
Collector-to-Emitter Breakdown Voltage	V <sub>(BR)CES</sub>	I <sub>C</sub> = -100μA, R <sub>BE</sub> =0	-50			V
Collector-to-Emitter Breakdown Voltage	V <sub>(BR)CEO</sub>	I <sub>C</sub> = -1mA, R <sub>BE</sub> =∞	-50			V
Emitter-to-Base Breakdown Voltage	V <sub>(BR)EBO</sub>	I <sub>E</sub> = -10μA, I <sub>C</sub> =0A	-6			V
Turn-On Time	t <sub>on</sub>			30		ns
Storage Time	t <sub>stg</sub>	See specified Test Circuit.		230		ns
Fall Time	t <sub>f</sub>			18		ns

### Switching Time Test Circuit

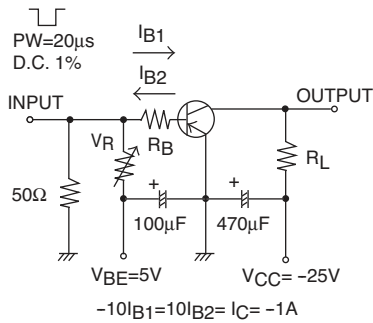

### Ordering Information

Device	Package	Shipping	memo
2SA2126-E	TP	500pcs./bag	Pb Free
2SA2126-H	TP	500pcs./bag	Pb Free and Halogen Free
2SA2126-TL-E	TP-FA	700pcs./reel	Pb Free
2SA2126-TL-H	TP-FA	700pcs./reel	Pb Free and Halogen Free

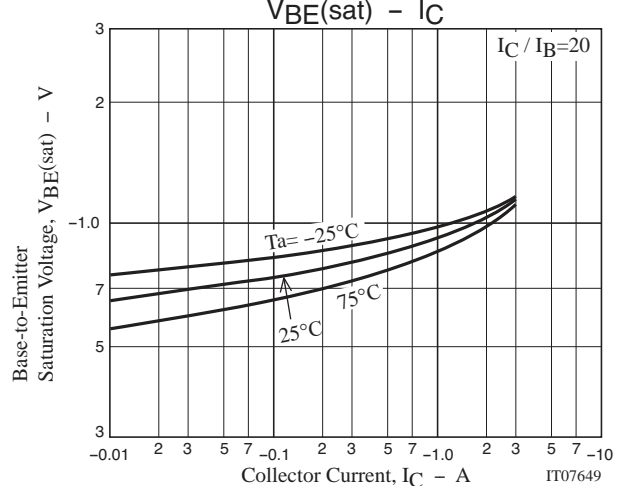
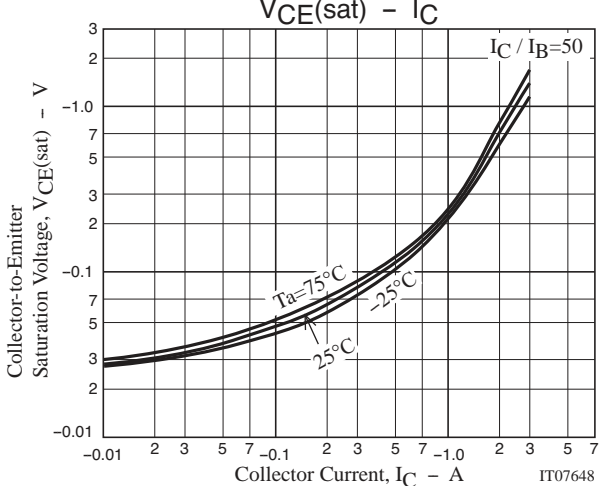
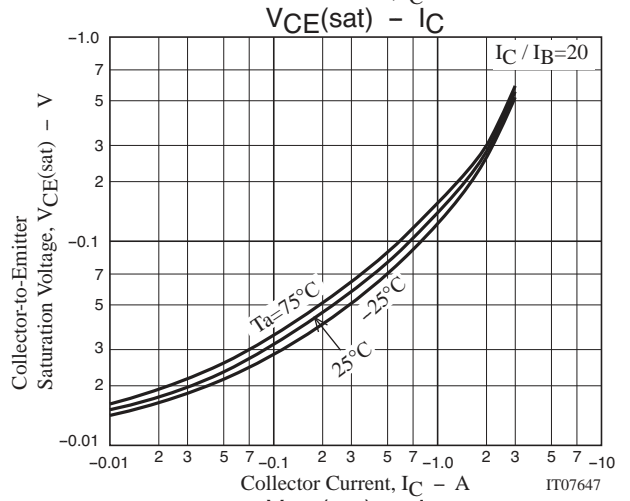
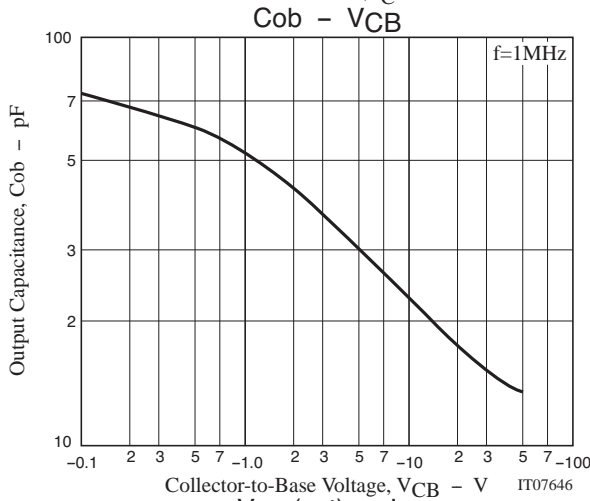
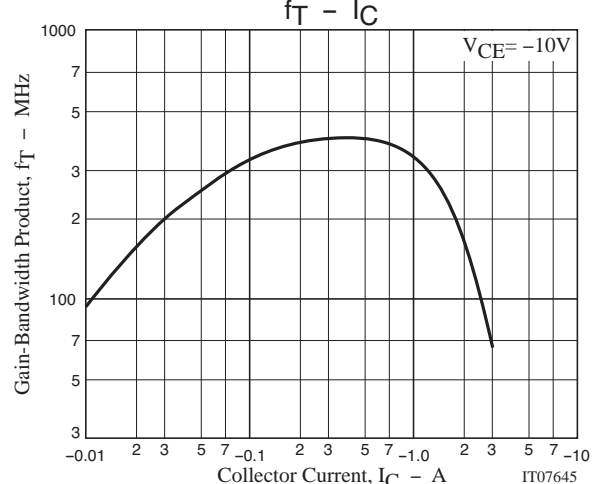
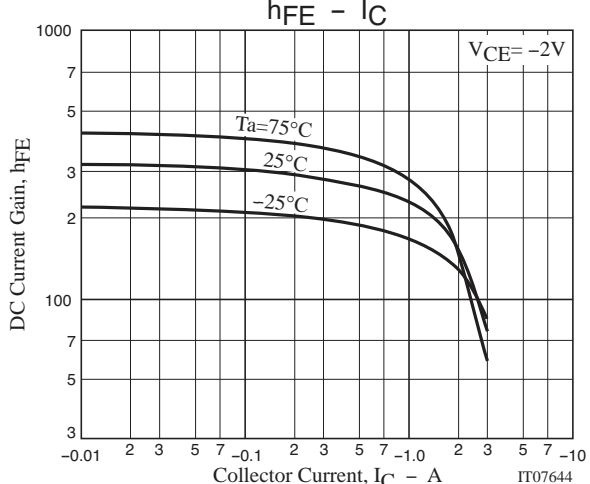
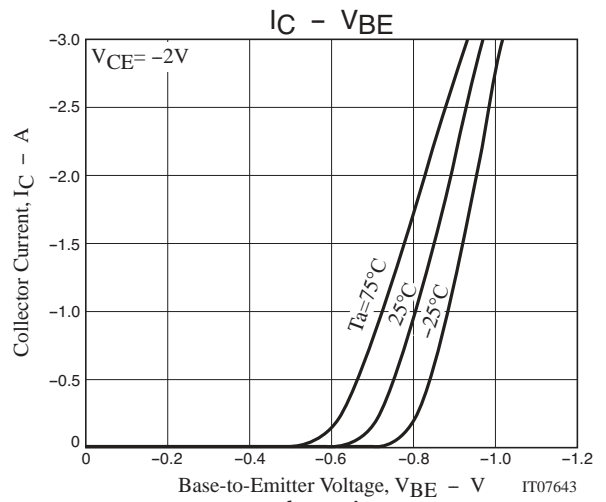
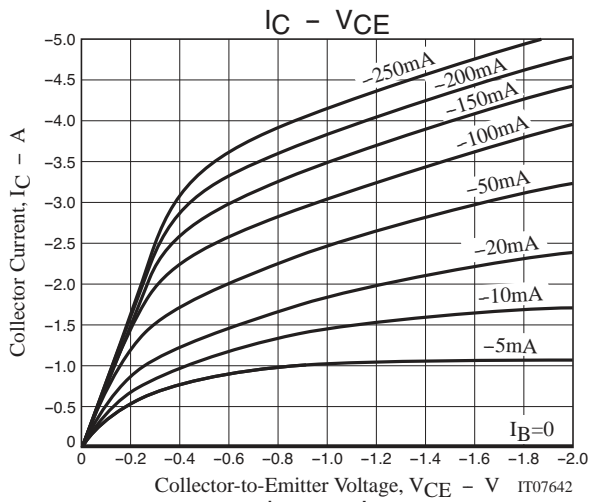

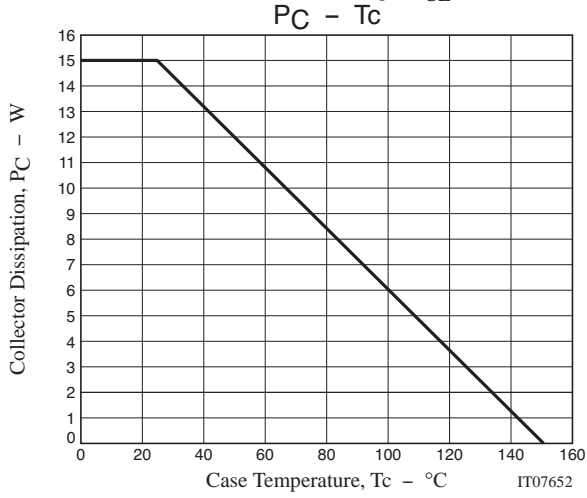
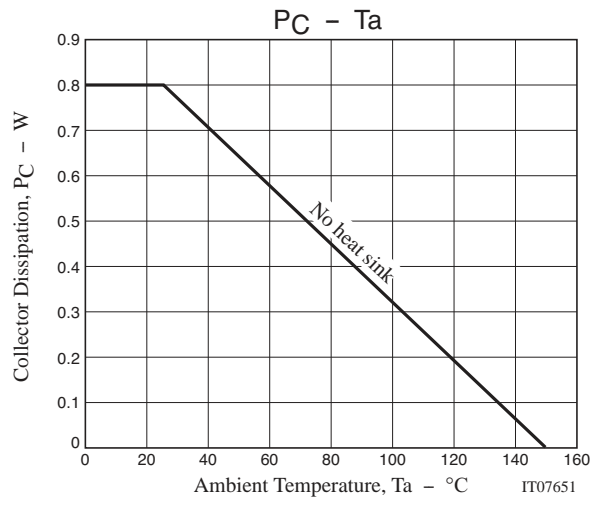
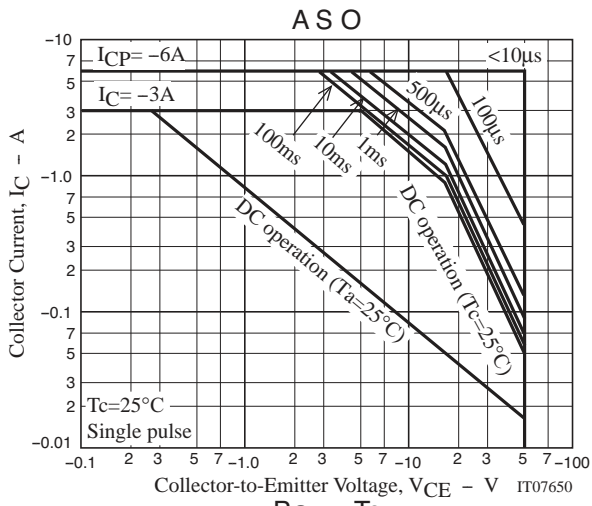

Taping Specification

2SA2126-TL-E, 2SA2126-TL-H

Packing Format

Package Name	Carrier Tape Type	Maximum Number of devices contained (pcs)			Packing format	
		Reel	Inner box	Outer box	Inner BOX (C-1)	Outer BOX (A-7)
TP-FA	TP	700	2,100	12,600	3 reels contained Dimensions:mm (external) 183×72×185	6 inner boxes contained Dimensions:mm (external) 440×195×210

Reel label, Inner box label  
(unit:mm)

Outer box label

It is a label at the time of factory shipments.  
The form of a label may change in physical distribution process.

Packing method

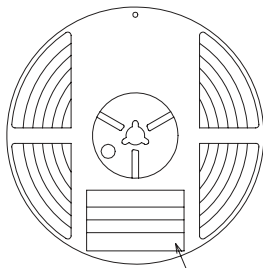

Type No.  
LOT No.  
Quantity  
Origin

Reel label

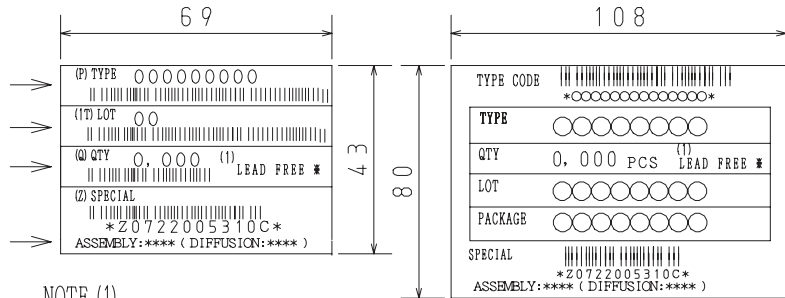

NOTE (1)

The LEAD FREE \* description shows that the surface treatment of the terminal is lead free.

Label	JEITA Phase
LEAD FREE 3	JEITA Phase 3A
LEAD FREE 4	JEITA Phase 3

Taping configuration

1. Carrier tape size (unit:mm)

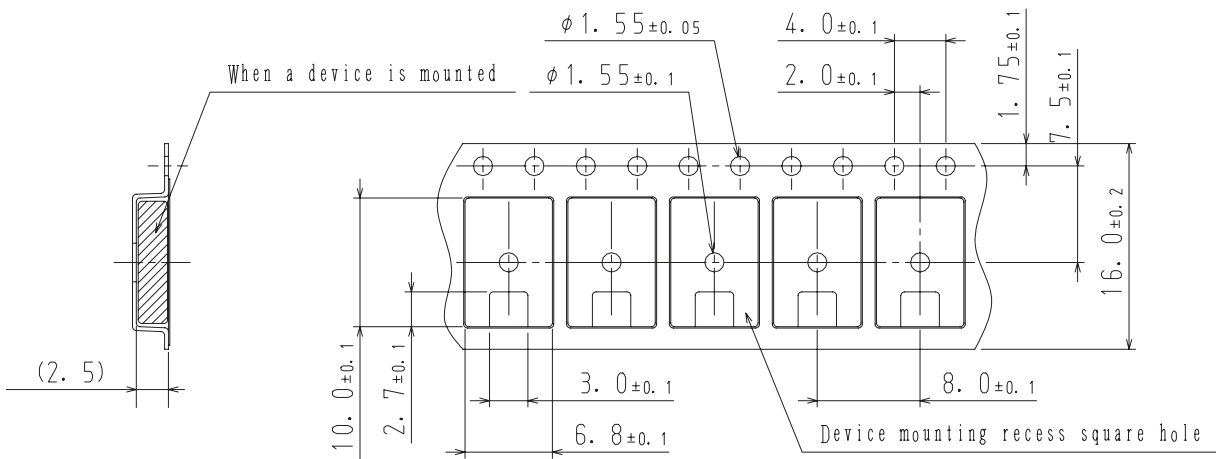

2. Device placement direction

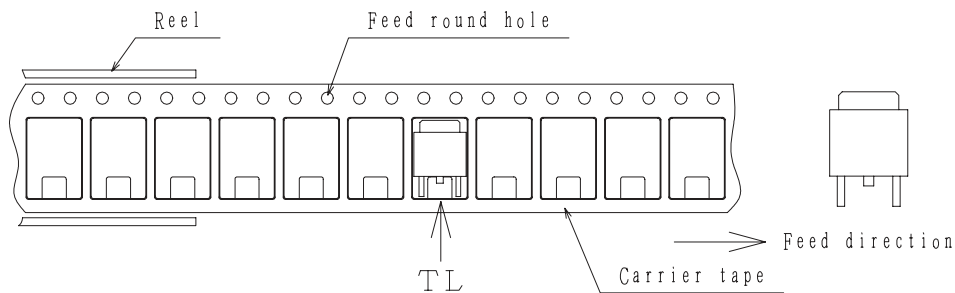

Those with one electrode terminal on the feed hole side.....TL

# 2SA2126

## Outline Drawing

2SA2126-TL-E, 2SA2126-TL-H

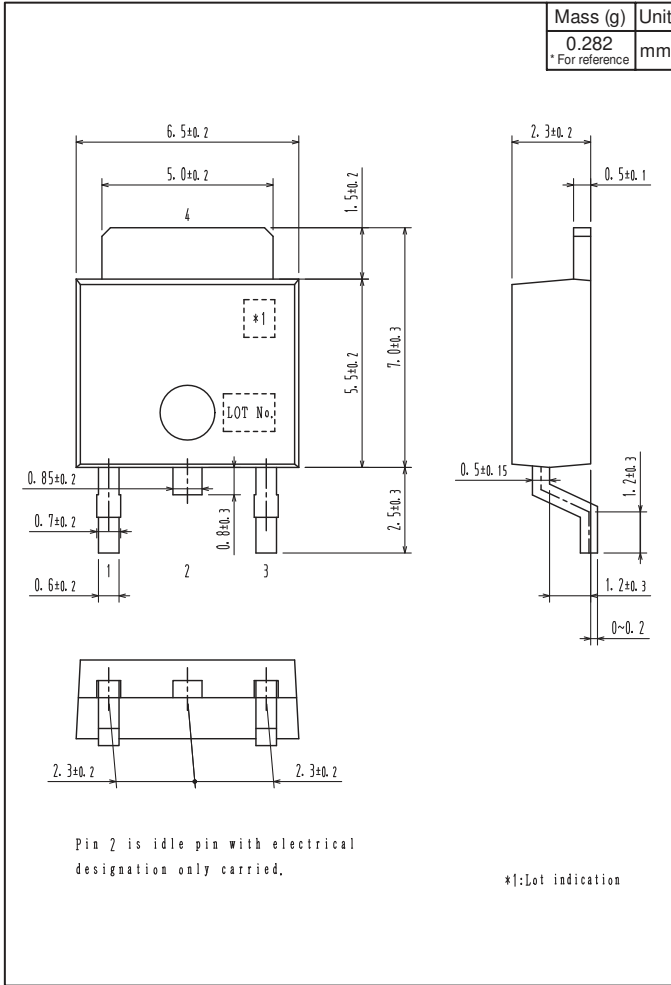

## Land Pattern Example

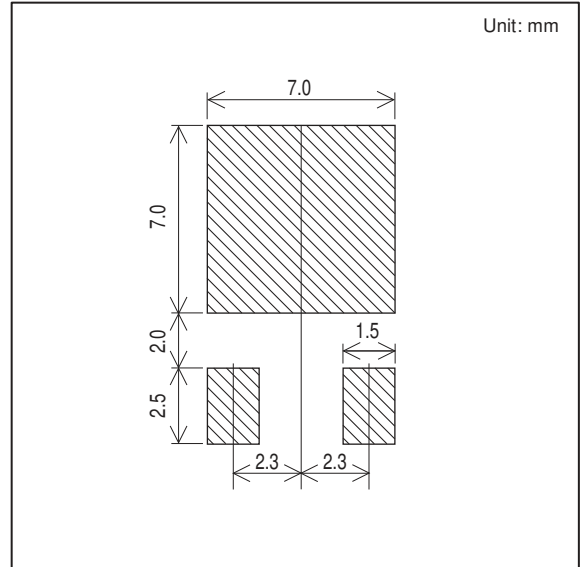

**Bag Packing Specification**

2SA2126-E, 2SA2126-H

1. Packing Format

Package Name	Maximum Number of devices contained (pcs)			
	Bag	Inner box	Outer box	
TP	500	B-1	A-1	A-2
		10,000	50,000	30,000
	Packing format (Dimensions:mm (external))			
		Inner box	Outer box	
		B-1	A-1	A-2
		445×225×55	470×250×300	470×250×190

2. Bag dimensions  
(unit:mm)

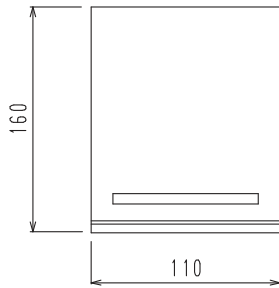

3. Bag label, Inner box label  
(unit:mm)

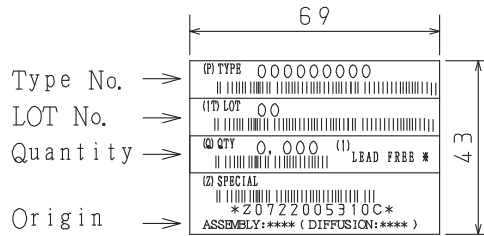

4. Outer box label  
(unit:mm)

It is a label at the time of factory shipments,  
The form of a label may change in physical  
distribution process,

NOTE (1)

The LEAD FREE \* description shows that the  
surface treatment of the terminal is lead free.

Label	JEITA Phase
LEAD FREE 3	JEITA Phase 3A
LEAD FREE 4	JEITA Phase 3

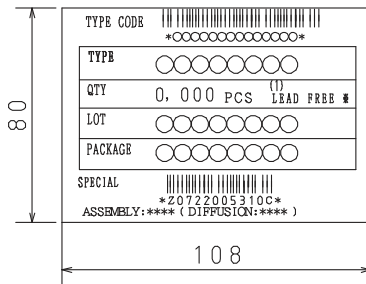

# 2SA2126

## Outline Drawing

2SA2126-E, 2SA2126-H

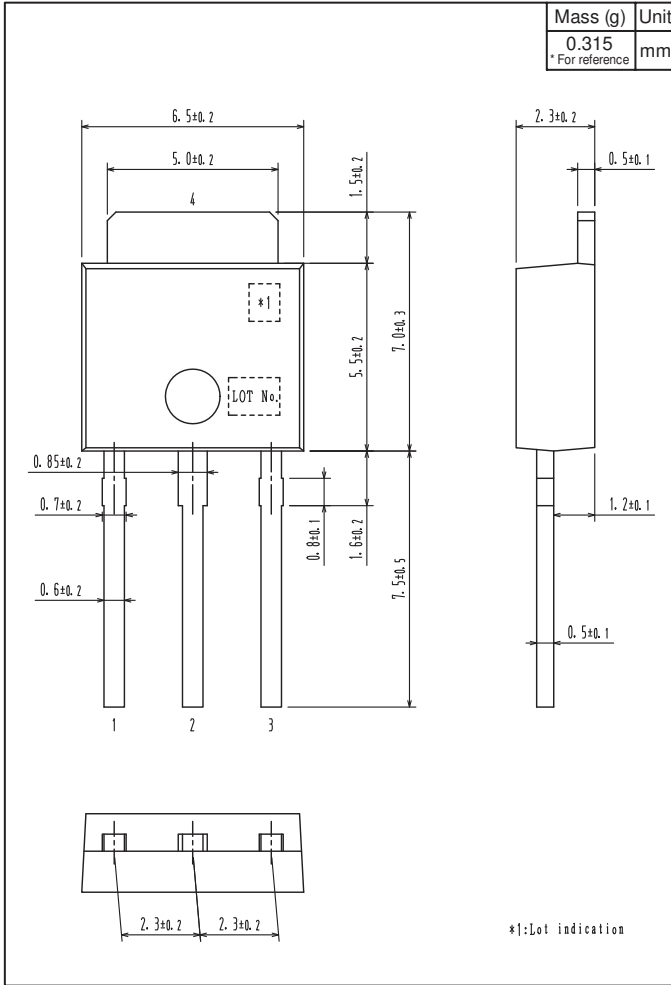



ON Semiconductor and the ON logo are registered trademarks of Semiconductor Components Industries, LLC (SCILLC). SCILLC owns the rights to a number of patents, trademarks, copyrights, trade secrets, and other intellectual property. A listing of SCILLC's product/patent coverage may be accessed at [www.onsemi.com/site/pdf/Patent-Marking.pdf](http://www.onsemi.com/site/pdf/Patent-Marking.pdf). SCILLC reserves the right to make changes without further notice to any products herein. SCILLC makes no warranty, representation or guarantee regarding the suitability of its products for any particular purpose, nor does SCILLC assume any liability arising out of the application or use of any product or circuit, and specifically disclaims any and all liability, including without limitation special, consequential or incidental damages. "Typical" parameters which may be provided in SCILLC data sheets and/or specifications can and do vary in different applications and actual performance may vary over time. All operating parameters, including "Typicals" must be validated for each customer application by customer's technical experts. SCILLC does not convey any license under its patent rights nor the rights of others. SCILLC products are not designed, intended, or authorized for use as components in systems intended for surgical implant into the body, or other applications intended to support or sustain life, or for any other application in which the failure of the SCILLC product could create a situation where personal injury or death may occur. Should Buyer purchase or use SCILLC products for any such unintended or unauthorized application, Buyer shall indemnify and hold SCILLC and its officers, employees, subsidiaries, affiliates, and distributors harmless against all claims, costs, damages, and expenses, and reasonable attorney fees arising out of, directly or indirectly, any claim of personal injury or death associated with such unintended or unauthorized use, even if such claim alleges that SCILLC was negligent regarding the design or manufacture of the part. SCILLC is an Equal Opportunity/Affirmative Action Employer. This literature is subject to all applicable copyright laws and is not for resale in any manner.