

Digitally controlled audio processor

Features

- Input multiplexer
 - Four stereo, one mono input, and one differential input
 - Selectable input gain for optimal adaptation to different sources
- Fully programmable loudness function
- Volume control in 1dB steps including gain up to 16dB
- Zero crossing mute, soft mute and direct mute
- Bass and treble control
- Four speaker attenuators- four independent speakers control in 1dB steps for balance and fader facilities
- Pause detector programmable threshold
- All functions programmable via serial I²C bus

Description

The audioprocessor TDA7437N is an upgrade of the TDA731X audioprocessor family.

Due to a highly linear signal processing, using CMOS-switching techniques instead of standard bipolar multipliers, very low distortion and very



low noise are obtained. Several new features like softmute, and zero-crossing mute are implemented. The soft Mute function can be activated in two ways either via the serial bus (Mute byte, bit D0), or directly on pin 28 through an I/O line of the microcontroller

Very low DC stepping is obtained by use of a BICMOS technology.

Order codes

Part numbers	Package	Packing
E-TDA7437N	LQFP44 (10x 10x 1.4mm)	Tray
E-TDA7437NTR	LQFP44 (10x 10x 1.4mm)	Tape and reel

Contents

1	PIN descriptions and electrical specifications	6
2	Electrical characteristics	9
3	I2C bus interface	13
3.1	Data validity	13
3.2	Start and stop conditions	13
3.3	Byte format	13
3.4	Acknowledge	13
3.5	Transmission without acknowledgment	13
4	Software specification	15
4.1	Interface protocol	15
4.2	Auto increment	15
4.3	Subaddress (receive mode)	15
4.4	Transmitted data	16
4.5	Data byte specification	16
5	Mute and pause features	22
5.1	Soft mute	22
5.2	Direct mute	22
5.3	Speakers mute	23
5.4	Zero crossing mute	23
5.5	Pause function	23
5.6	No symmetrical bass cut response	24
5.7	Transmitted data (send mode)	24
5.8	TDA7437N I2C bus protocol	25
5.9	I2C bus read mode	26
5.10	Loudness stage	26
5.11	Treble stage	26
5.12	IN-OUT pins	26
5.13	Bass & mid filters	27

5.14	Input selector	27
6	Curves of electrical characteristics	28
7	Package information	32
8	Revision history	33

Obsolete Product(s) - Obsolete Product(s)

List of tables

Table 1.	Absolute maximum ratings	6
Table 2.	Thermal data	6
Table 3.	Quick reference data	6
Table 4.	Electrical characteristics	9
Table 5.	Subaddress (receive mode)	15
Table 6.	Send mode	16
Table 7.	Data byte specification	16
Table 8.	Loudness	16
Table 9.	Mute	17
Table 10.	Volume	18
Table 11.	Speaker	19
Table 12.	Bass treble	19
Table 13.	Input stage gain middle	20
Table 14.	Document revision history	33

List of figures

Figure 1.	Pin description	6
Figure 2.	Block diagram	8
Figure 3.	CLD and CDR	12
Figure 4.	Data validity	14
Figure 5.	Timing diagram of I ² C Bus	14
Figure 6.	Acknowledge on the I ² C Bus	14
Figure 7.	Power on time constant vs CREF capacitor CREF = 4.7mF	28
Figure 8.	Power on time constant vs CREF capacitor CREF = 10mF	28
Figure 9.	Power on time constant vs CREF capacitor CREF = 22mF	28
Figure 10.	SVRR vs. frequency	28
Figure 11.	Soft mute ON	28
Figure 12.	Soft mute OFF	29
Figure 13.	Zero crossing mute ON	29
Figure 14.	Zero crossing mute OFF	29
Figure 15.	Pause detector	29
Figure 16.	Pause detector	29
Figure 17.	Symmetrical bass	30
Figure 18.	unsymmetrical bass	30
Figure 19.	Loudness	30
Figure 20.	Test board diagram	31
Figure 21.	LQFP44 (10x10) Mechanical data and package dimensions	32

1 PIN descriptions and electrical specifications

Figure 1. Pin description

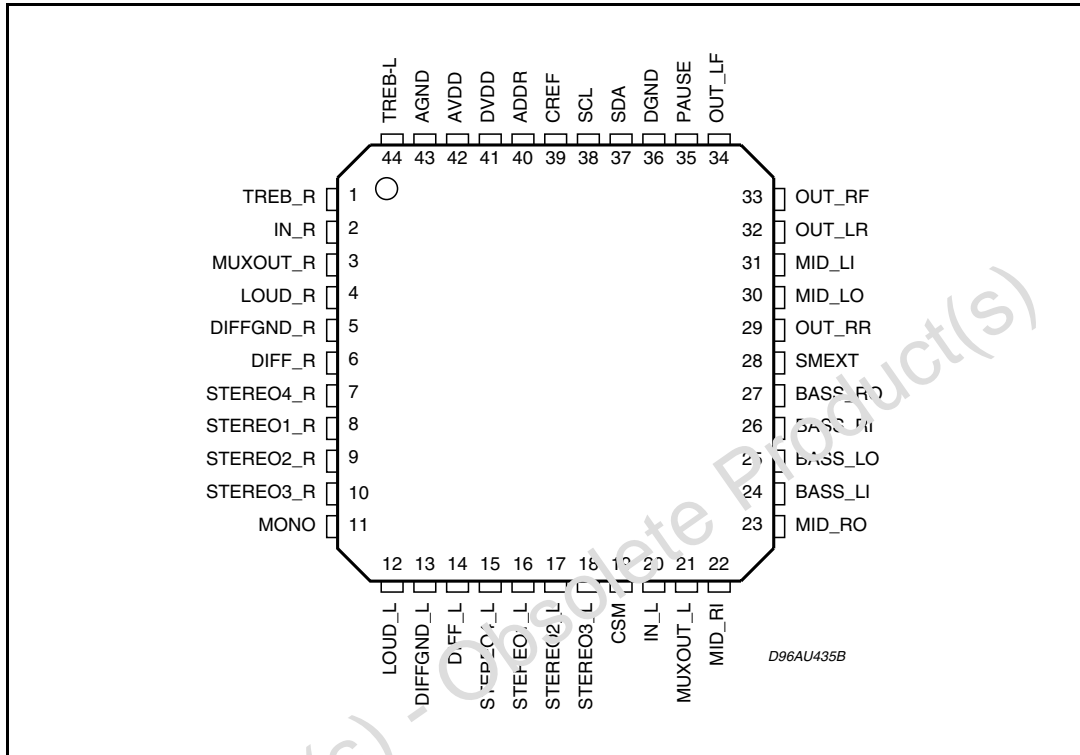

Table 1. Absolute maximum ratings

Symbol	Parameter	Value	Unit
V_{DD}, V_{CL}	Operating supply voltage	10.5	V
T_{amb}	Operating ambient temperature	-40 to 85	°C
T_{stg}	Storage temperature range	-55 to 150	°C

Table 2. Thermal data

Symbol	Parameter	Value	Unit
$R_{th\ j-amb}$	Thermal resistance junction to pins Max.	150	°C/W

Table 3. Quick reference data

Symbol	Parameter	Min.	Typ.	Max.	Unit
V_{DD}, V_{DD}	Supply voltage (AVDD and DVDD must be at the same potential)	6	9	10.2	V
V_{CL}	Max. input signal handling	2.1	2.6		Vrms
THD	Total harmonic distortion $V = 1V_{rms}$ $f = 1KHz$		0.01	0.8	%
S/N	Signal to noise ratio		111		dB
S_C	Channel separation $f = 1KHz$		95		dB

Table 3. Quick reference data (continued)

Symbol	Parameter	Min.	Typ.	Max.	Unit
	Input gain 1dB step	0		15	dB
	Volume control 1dB step	-63		16	dB
	Treble control 2dB step	-14		+14	dB
	Bass control 2dB step	-14		+14	dB
	Middle control 2dB step	-14		+14	dB
	Fader and balance control 1dB step	-79		0	dB
	Loudness control 1dB step	0		20	dB
	Mute attenuation		100		dB

Figure 2. Block diagram

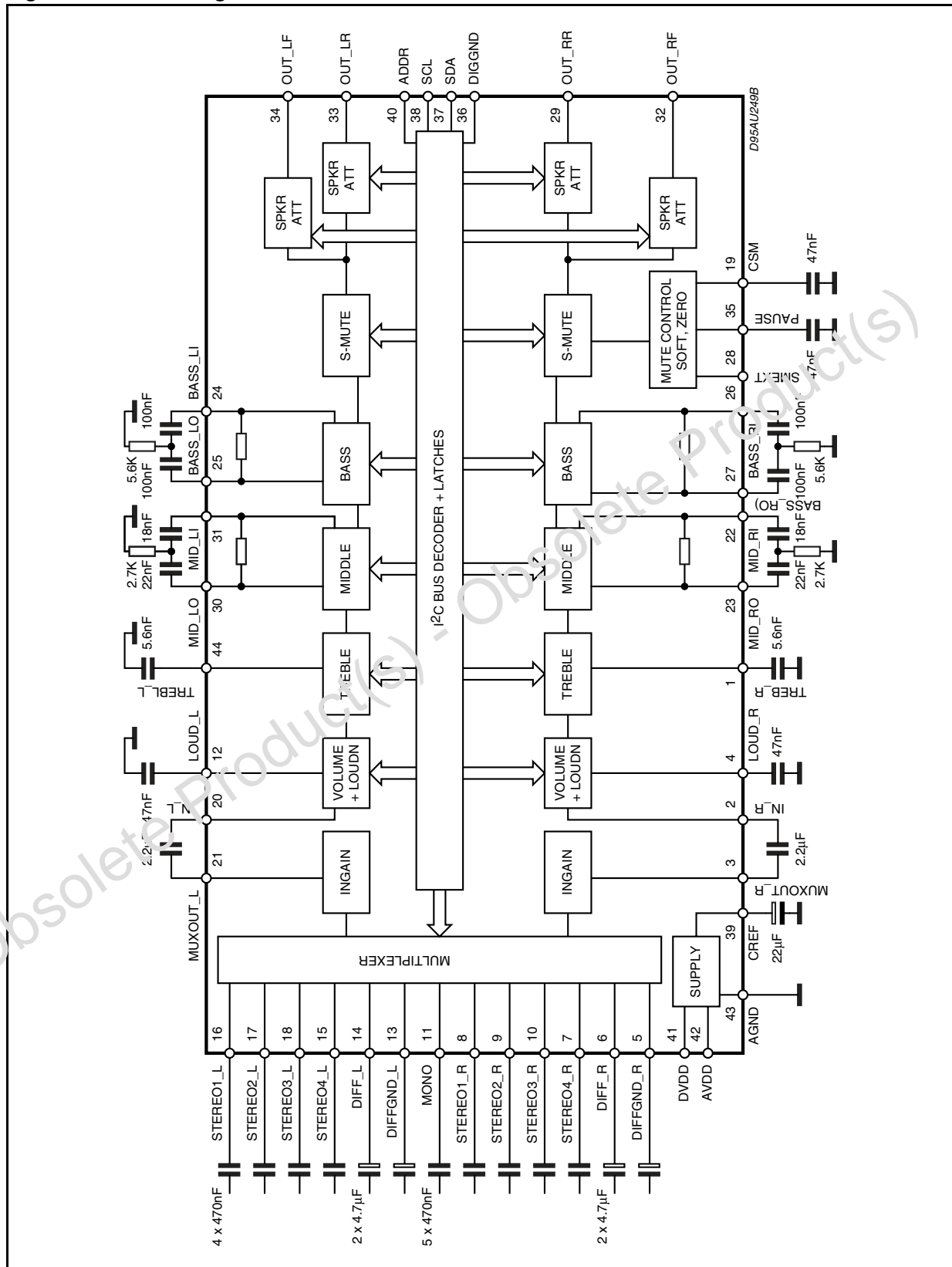

2 Electrical characteristics

(AV_{DD} , $DV_{DD} = 9V$; $R_L = 10K\Omega$; $R_g = 50\Omega$; $T_{amb} = 25^\circ C$; all gains = 0dB; $f = 1KHz$. Refer to the test circuit, unless otherwise specified.)

Table 4. Electrical characteristics

Symbol	Parameter	Test condition	Min.	Typ.	Max.	Unit
Input selector (mono and stereo inputs)						
R_I	Input resistance	pin 7 to 11 and 15 to 18	70	100	130	$K\Omega$
V_{CL}	Clipping level	$d \leq 0.3\%$	2.1	2.6		V_{RMS}
S_I	Input separation		80	95		dB
R_L	Output load resistance		2			$K\Omega$
$G_{I\ MIN}$	Minimum input gain		-0.75	0	+0.75	dB
$G_{I\ MAX}$	Maximum input gain		14	15	16	dB
G_{step}	Step resolution		0.5	1.0	1.5	dB
E_a	Set error		-1.0	0	1.0	dB
V_{DC}	DC steps	Adjacent gain steps		0.5	10	mV
		$G_{I\ MIN}$ to $G_{I\ MAX}$		3		mV
Differential input (Pin 5, 6, 13, 14)						
R_I	Input resistance	Input selector BIT D4 = 0 (0dB)	10	15	20	$K\Omega$
		Input selector BIT D4 = 1 (-6dB)	14	20	26	$K\Omega$
$CMRR$	Common mode rejection ratio	$V_{CM} = 1V_{RMS}$; $f = 1KHz$	45	70		dB
d	Distortion	$V_I = 1V_{RMS}$		0.01	0.08	%
e_{IN}	Input noise	20Hz to 20KHz; Flat; D6 = 0		5		μV
G_{DIFF}	Differential gain	D4 = 0	-1	0	1	dB
		D4 = 1	-7	-6	-5	dB
Volume control						
R_I	Input resistance	Pin 2 and 20	31	44	57	$K\Omega$
G_{MAX}	Maximum gain		15	16	17	dB
A_{MAX}	Maximum attenuation		61	63.75	66.5	dB
A_{STEP}	Step resolution coarse atten.		0.5	1.0	1.5	dB
E_A	Attenuation set error	$G = 16$ to $-20dB$	-1.0	0	1.0	dB
		$G = -20$ to $-63dB$	-2.75		2.75	dB
E_t	Tracking error				2	dB

Table 4. Electrical characteristics (continued)

Symbol	Parameter	Test condition	Min.	Typ.	Max.	Unit
V _{DC}	DC steps	Adjacent gain steps	-5		+5	mV
		Adjacent attenuation steps	-3		+3	mV
		From 0dB to A _{MAX}		0.5	5	mV
Loudness control (Pin 4, 12)						
R _I	Internal resistor	Loud = On	35	50	65	KΩ
A _{MAX}	Maximum attenuation		19	20	21	dB
A _{step}	Step resolution		0.5	1	1.5	dB
Zero crossing mute						
V _{TH}	Zero crossing threshold ⁽¹⁾	WIN = 11		35		mV
		WIN = 10		70		mV
		WIN = 01		140		mV
		WIN = 00		280		mV
A _{MUTE}	Mute attenuation		80	100		dB
V _{DC}	DC step	0dB to Mute		0.1	3	mV
Soft mute						
A _{MUTE}	Mute attenuation		50	65		dB
T _{DON}	ON delay time	C _{CSM} = 22nF; 0 to -20dB; I = I _{MAX}	0.8	1.5	2.0	ms
		C _{CSM} = 22nF; 0 to -20dB; I = I _{MIN}	25	45	60	ms
T _{DOFF}	OFF current	V _{CSM} = 0V; I = I _{MAX}	20	40	60	mA
		V _{CSM} = 0V; I = I _{MIN}		2		μA
R _{PULLUP}	Pullup resistor (pin 28)	⁽²⁾		100		KΩ
V _{SMH}	(pin 28) Level high		3.5			V
V _{SML}	(pin 28) Level low	Soft mute active			1	V
Bass control						
C _{range}	Control range		±11.5	±14	±16	dB
A _{step}	Step resolution		1	2	3	dB
R _g	Internal feedback resistance		31	44	57	KΩ
Middle control						
C _{range}	Control range		±11.5	±14	±16	dB
A _{step}	Step resolution		1	2	3	dB
R _g	Internal feedback resistance		17.5	25	32.5	KΩ

Table 4. Electrical characteristics (continued)

Symbol	Parameter	Test condition	Min.	Typ.	Max.	Unit
Treble control						
C_{RANGE}	Control range		±13	±14	±15	dB
A_{step}	Step resolution		1	2	3	dB
Speaker attenuators						
C_{RANGE}	Control range			79		dB
A_{step}	Step resolution	$A_V = 0$ to -40dB	0.5	1	1.5	dB
A_{MUTE}	Output mute attenuation	Data word = 1111XXXX	80	100		dB
E_A	Attenuation set error	$A_V = 0$ to -40dB			1.5	dB
V_{DC}	DC steps	Adjacent attenuation steps		0.1	3	mV
Audio output						
V_{clip}	Clipping level	$d = 0.3\%$	2.1	2.6		V _{rms}
R_L	Output load resistance		2			$\text{K}\Omega$
R_O	Output impedance		50	90	140	Ω
V_{DC}	DC voltage level		3.5	3.8	4.1	V
Pause detector						
V_{TH}	Pause threshold	WIN = 11		35		mV
		WIN = 10		70		mV
		WIN = 01		140		mV
		WIN = 00		280		mV
I_{DELAY}	Full-up current		15	25	35	μA
V_{THP}	Pause threshold			3.0		V
General						
V_{CC}	Supply voltage		6	9	10.2	V
I_{CC}	Supply current		7	10	13	mA
PSRR	Power supply rejection ratio	$f = 1\text{KHz}$	70	90		dB
e_{NO}	Output noise	Output muted ($B = 20$ to 20kHz flat)		4		μV
		All gains 0dB ($B = 200$ to 20kHz flat)		6	15	μV
E_t	Total tracking error	$A_V = 0$ to -20dB		0	1	dB
		$A_V = -20$ to -60dB		0	2	dB
S/N	Signal to noise ratio	All Gains = 0dB ; $V_O = 2.1\text{V}_{\text{rms}}$		111		dB
S_C	Channel separation L - R		80	95		dB

Table 4. Electrical characteristics (continued)

Symbol	Parameter	Test condition	Min.	Typ.	Max.	Unit
d	Distortion	$V_{IN} = 1V$ all gain = 0dB		0.01	0.08	%
Bus inputs						
V_{IL}	Input low voltage				1	V
V_{IN}	Input high voltage		3			V
I_{IN}	Input current	$V_{IN} = 0.4V$	-5		5	μA
V_O	Output voltage SDA acknowledge	$I_O = 1.6mA$		0.1	0.4	V

1. WIN represents the MUTE programming bit pair D6, D5 for the zero crossing window threshold
2. Internal pullup resistor to $V_s/2$; "LOW" = softmute active

Note: The ANGND and DIGGND layout wires must be kept separated. A 50Ω resistor is recommended to be put as far as possible from the device.

The CLD - and CDR - can be short-circuited in applications providing 3 wires CD signal

Figure 3. CLD and CDR

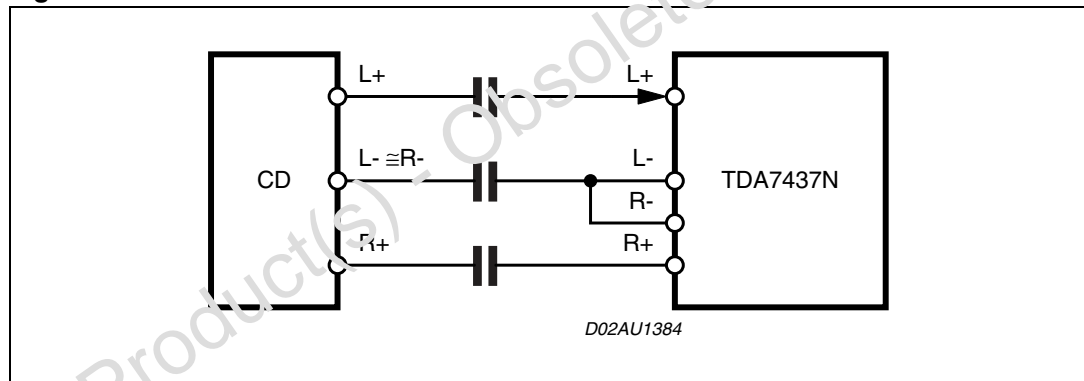

CLD - = DIFFINLGND

CDR - = DIFFINRGND

3 I²C bus interface

Data transmission from the microprocessor to the TDA7437N, and vice versa, takes place through the 2 wires of the I²C BUS interface, consisting of the two lines SDA and SCL (pull-up resistors to positive supply voltage must be externally connected).

3.1 Data validity

As shown in [Figure 4](#), the data on the SDA line must be stable during the high period of the clock. The HIGH and LOW state of the data line can only change when the clock signal on the SCL line is LOW.

3.2 Start and stop conditions

As shown in [Figure 5](#) a start condition is a HIGH to LOW transition on the SDA line while SCL is HIGH. The stop condition is a LOW to HIGH transition on the SDA line while SCL is HIGH. A STOP conditions must be sent before each START condition.

3.3 Byte format

Every byte transferred to the SDA line must contain 8 bits. Each byte must be followed by an acknowledge bit. The MSB is transferred first.

3.4 Acknowledge

The master (microprocessor) puts a resistive HIGH level on the SDA line during the acknowledge clock pulse (see [Figure 6](#)). The peripheral (audioprocessor) that acknowledges has to pull-down (LOW) the SDA line during the acknowledge clock pulse, so that the SDA line is stable LOW during this clock pulse. The audioprocessor which has been addressed has to generate an acknowledgment after the reception of each byte, otherwise the SDA line remains at the HIGH level during the ninth clock pulse time. In this case the master transmitter can generate the STOP information in order to abort the transfer.

3.5 Transmission without acknowledgment

To avoid detection of the acknowledge clock pulse of the audioprocessor, the microprocessor can use a simpler transmission: it simply waits one clock pulse, and sends the new data. This is less protected from any errors and will decrease the immunity to noise.

Figure 4. Data validity

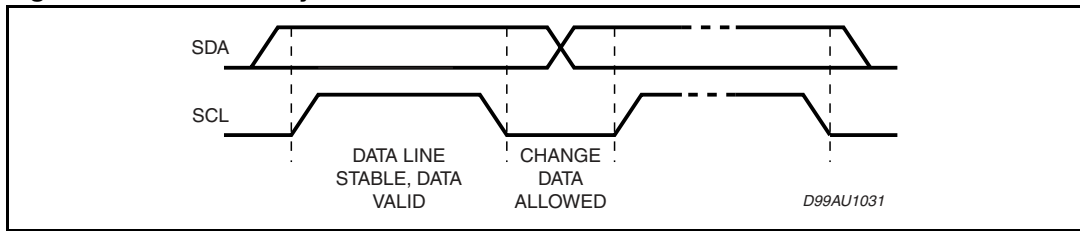

Figure 5. Timing diagram of I²C Bus

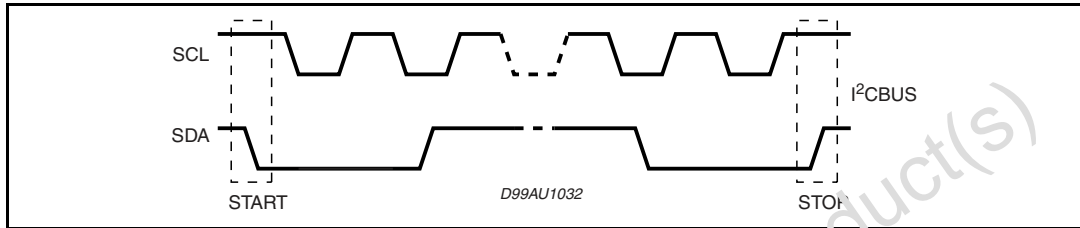
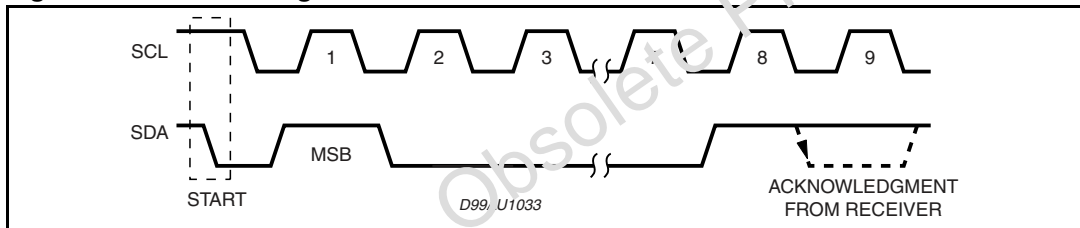

Figure 6. Acknowledge on the I²C Bus



4 Software specification

4.1 Interface protocol

The interface protocol comprises of:

- A start condition (s)
- A chip address byte, (the LSB bit determines read (=1)/write (=0) transmission)
- A subaddress byte.
- A sequence of data (N-bytes + acknowledge)
- A stop condition (P)

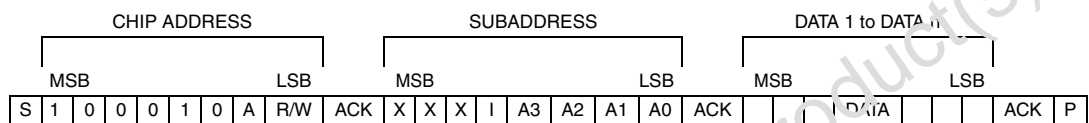

ACK = Acknowledge; S = Start; P = Stop; I = Auto increment, X = Not used

Max clock speed 500kbits/s

ADDRpin open A = 0

ADDRpin close to Vs A = 1

4.2 Auto increment

If bit I in the subaddress byte is set to "1", the autoincrement of the subaddress is enabled.

4.3 Subaddress (receive mode)

Table 5. Subaddress (receive mode)

MSB								LSB	FUNCTION
X	X	X	I	A3	A2	A1	A0		
				0	0	0	0		Input selector
				0	0	0	1		Loudness
				0	0	1	0		Volume
				0	0	1	1		Bass, Treble
				0	1	0	0		Speaker attenuator LF
				0	1	0	1		Speaker attenuator LR
				0	1	1	0		Speaker attenuator RF
				0	1	1	1		Speaker Attenuator RR
				1	0	0	0		Input gain middle
				1	0	0	1		Mute

4.4 Transmitted data

Table 6. Send mode

MSB							LSB
X	X	X	X	X	SM	ZM	P

\bar{P} = Pause (Active low)
 ZM = Zero crossing muted (HIGH active)
 SM = Soft mute activated (HIGH active)
 X = Not used

The transmitted data is automatically updated after each ACK.
 Transmission can be repeated without new chipaddress.

4.5 Data byte specification

Table 7. Data byte specification

MSB							LSB	Function
D7	D6	D5	D4	D3	D2	D1	D0	
				1	0	0	0	Differential
				1	0	0	1	Stereo 1
				1	0	1	0	Stereo 2
				1	0	1	1	Stereo 3
				1	1	0	0	Stereo 4
				1	1	0	1	Mono
X	X	X	X	0	X	X	X	DC connect ⁽¹⁾
		0	0					Half-diff 0dB ⁽²⁾
		0	1					Half-diff -6dB ⁽²⁾
		1	0					Full-diff 0dB ⁽³⁾
		1	1					Full-diff -6dB ⁽³⁾

1. Selected when using a 3 wire differential source (pins 5 and 13 shorted)
2. Selected when using a 4 wire differential source
3. OUTR-INR (OUTL-INR) short circuited internally (no need for external connection)

Table 8. Loudness

MSB							LSB	Function
D7	D6	D5	D4	D3	D2	D1	D0	Loudness step
		0	0	0	0	0	0	0dB
		0	0	0	0	0	1	1dB
		0	0	0	0	1	0	2dB
		0	0	0	0	1	1	3dB

Table 8. Loudness (continued)

MSB							LSB	Function
D7	D6	D5	D4	D3	D2	D1	D0	Loudness step
		0	0	0	1	0	0	4dB
		0	0	0	1	0	1	5dB
		0	0	0	1	1	0	6dB
		0	0	0	1	1	1	7dB
		0	0	1	0	0	0	8dB
		0	0	1	0	0	1	9dB
		0	0	1	0	1	0	10dB
		0	0	1	0	1	1	11dB
		0	0	1	1	0	0	12dB
		0	0	1	1	0	1	13dB
		0	0	1	1	1	0	14dB
		0	0	1	1	1	1	15dB
		0	1	0	0	0	0	16dB
		0	1	0	0	0	1	17dB
		0	1	0	0	1	0	18dB
		0	1	0	0	1	1	19dB
		0	1	0	1	0	0	20dB
								Loudness off
								Fine volume
0	0							0dB
0	1							-0.25dB
1	0							-0.5dB
1	1							-0.75dB

Table 9. Mute

MSB							LSB	Function
D7	D6	D5	D4	D3	D2	D1	D0	
				0			1	Soft mute on
				0		0	1	soft mute with fast slope
				0		1	1	Soft mute with slow slope
			0	0	1			Zero mute
				1				Direct mute
			1					Reset

Table 9. Mute (continued)

MSB							LSB		Function
D7	D6	D5	D4	D3	D2	D1	D0		
	0	0	0					Zero cross window (280mV)	
	0	1	0					Zero cross window (140mV)	
	1	0	0					Zerocross window (70mV)	
	1	1	0					Zerocross window (35mV)	
0								Non symmetrical bass	
1								Symmetrical bass	

Table 10. Volume

MSB							LSB		Function
D7	D6	D5	D4	D3	D2	D1	D0		
1					0	0	0	0dB	
1					0	0	1	-1dB	
1					0	1	0	-2dB	
1					0	1	1	-3dB	
1					1	0	0	-4dB	
1					1	0	1	-5dB	
1					1	1	0	-6dB	
1					1	1	1	-7dB	
1									
1	0	0	0	0				16dB	
1	0	0	0	1				8dB	
1	0	0	1	0				0dB	
1	0	0	1	1				-8dB	
1	0	1	0	0				-16dB	
1	0	1	0	1				-24dB	
1	0	1	1	0				-32dB	
1	0	1	1	1				-40dB	
1	1	0	0	0				-48dB	
1	1	0	0	1				-56dB	
0	X	X	X	X	X	X	X	Mute	

Table 11. Speaker

MSB							LSB	Function
D7	D6	D5	D4	D3	D2	D1	D0	
								1.25dB step
					0	0	0	0dB
					0	0	1	-1dB
					0	1	0	-2dB
					0	1	1	-3dB
					1	0	0	-4dB
					1	0	1	-5dB
					1	1	0	-6dB
					1	1	1	-7dB
	0	0	0	0				0dB
	0	0	0	1				-8dB
	0	0	1	0				-16dB
	0	0	1	1				-24dB
	0	1	0	0				-32dB
	0	1	0	1				-40dB
	0	1	1	0				-48dB
	0		1	1				-56dB
	1	0	0	0				-64dB
		0	0	1				-72dB
	1	1	1	1	X	X	X	Mute

Table 12. Bass treble

MSB							LSB	Function
D7	D6	D5	D4	D3	D2	D1	D0	
								Treble step
				0	0	0	0	-14dB
				0	0	0	1	-12dB
				0	0	1	0	-10dB
				0	0	1	1	-8dB
				0	1	0	0	-6dB
				0	1	0	1	-4dB
				0	1	1	0	-2dB
				0	1	1	1	0dB

Table 12. Bass treble (continued)

MSB							LSB		Function
D7	D6	D5	D4	D3	D2	D1	D0		
				1	1	1	1	0dB	
				1	1	1	0	2dB	
				1	1	0	1	4dB	
				1	1	0	0	6dB	
				1	0	1	1	8dB	
				1	0	1	0	10dB	
				1	0	0	1	12dB	
				1	0	0	0	14dB	
								Bass steps	
0	0	0	0					-14dB	
0	0	0	1					-12dB	
0	0	1	0					-10dB	
0	0	1	1					-8dB	
0	1	0	0					-6dB	
0	1	0	1					-4dB	
0	1	1	0					-2dB	
0	1	1	1					0dB	
1	1	1	1					0dB	
	1	1	0					2dB	
1	1	0	1					4dB	
	1	0	0					6dB	
1	0	1	1					8dB	
	0	1	0					10dB	
1	0	0	1					12dB	
1	0	0	0					14dB	

Table 13. Input stage gain middle

MSB							LSB		Function
D7	D6	D5	D4	D3	D2	D1	D0		
								In-gain step	
				0	0	0	0	0dB	
				0	0	0	1	1dB	
				0	0	1	0	2dB	
				0	0	1	1	3dB	

Table 13. Input stage gain middle (continued)

MSB								LSB	Function
D7	D6	D5	D4	D3	D2	D1	D0		
				0	1	0	0	4dB	
				0	1	0	1	5dB	
				0	1	1	0	6dB	
				0	1	1	1	7dB	
				1	0	0	0	8dB	
				1	0	0	1	9dB	
				1	0	1	0	10dB	
				1	0	1	1	11dB	
				1	1	0	0	12dB	
				1	1	0	1	13dB	
				1	1	1	0	14dB	
				1	1	1	1	15dB	
								Middle step	
0	0	0	0					-14dB	
0	0	0	1					-12dB	
0	0	1	0					-10dB	
0	0	1	1					-8dB	
0	1	0	0					-6dB	
0	1	0	1					-4dB	
0	1	1	0					-2dB	
0	1	1	1					0dB	
1	1	1	1					0dB	
1	1	1	0					2dB	
1	1	0	1					4dB	
1	1	0	0					6dB	
1	0	1	1					8dB	
1	0	1	0					10dB	
1	0	0	1					12dB	
1	0	0	0					14dB	

5 Mute and pause features

The TDA7437N provides three types of mute, controlled via I²C bus (see [Table 9](#) Mute byte register).

5.1 Soft mute

Bit **D0 = 1** → **Soft mute ON**

Bit **D0 = 0** → **Soft mute OFF**

It allows an automatic soft muting and unmuting of the signal.

The time constant is fixed by an external capacitor C_{sm} inserted between pin C_{sm} and ground.

Once the external capacitor is fixed, two different slopes (time constant) are selectable by programming of bit D1.

Bit **D1 = 0** → **fast slope (I=I_{max})**

Bit **D1 = 1** → **slow slope (I=I_{min})**

The soft mute generates a gradually decreasing signal, avoiding big click noise of an immediate high attenuation, without necessity to program a sequence of decreasing volume levels. A response example is reported in [Figure 11](#) (mute), and [Figure 12](#) (unmute). The final attenuation obtained with soft mute ON is 60dB typical. The used reference parameter is the delay time taken to reach 20dB attenuation (no matter what the signal level is).

Using a capacitor C_{sm} = 22nF this delay is:

d = 1.8ms when selected Fast slope mode (bit D1=0)

d = 25 ms when selected Slow slope mode (bit D1=1)

In the application, the soft mute ON programming should be followed by programming of direct mute on (see [5.2](#)), in order to achieve a final 100dB attenuation. In addition to the I²C bus programming, the Soft Mute ON can be generated in a fast way by forcing a LOW level at pin SMEXT (TTL Level compatible). This approach is recommended for fast RDS AF switching.

The Soft Mute status can be detected via I²C bus, reading the Transmitted Byte, bit SM (see [Table 6](#)).

read bit SM = 1 soft mute status ON

read bit SM = 0 soft mute status OFF

5.2 Direct mute

bit **D3 = 1** Direct mute ON

bit **D3 = 0** Direct mute OFF

The direct mute bit forces an internal immediate signal connection to ground.

It is located just before the Volume/Loudness stage, and gives a typical 100dB attenuation.

5.3 Speakers mute

An additional direct mute function is included in the speakers attenuators stage.

The four output LF, RF, LR, RR can be separately muted by setting the speaker attenuator byte to the value 01111111 binary.

Typical attenuation level 100dB. This mute is useful for fader and balance functions. It should not be applied for system mute/unmute, because it can generate noise due to the offset of previous stages (bass / treble).

5.4 Zero crossing mute

bit **D2 = 1 D4 = 0** zero crossing mute ON

bit **D2 = 0 D4 = 0** zero crossing mute OFF

The mute activation/deactivation is delayed until the signal waveform crosses the DC zero level (Vref level).

The detection works separately for left and right channels (see [Figure 13](#) and [Figure 14](#)). Four different window thresholds are software selectable by two dedicated bits.

bit	D6 bit	D5	Window
	0	0	Vref DC +/-280mV
	0	1	Vref DC +/-140mV
	1	0	Vref DC +/-70mV
	1	1	Vref DC +/-35mV

The zero crossing mute activation/deactivation starts when the AC signal level falls inside the selected window (internal comparator).

The zero crossing mute (and pause) detector is always active. It can be disabled, if the feature is not used, by forcing the bit **D4 = 1** Zero crossing and pause detector reset.

In this way the internal comparator logic is stopped, eliminating its switching noise.

The zero cross mute status is detected reading the transmitted byte bit ZM.

bit **ZM = 1** zero cross mute status ON

bit **ZM = 0** zero cross mute status OFF

5.5 Pause function

On chip is implemented by a pause detector block.

It uses the same 4 windows threshold selectable for the zero crossing mute, bit D6,D5 byte MUTE (see above). The detector can be put into OFF by forcing bit **D4 = 1**, otherwise it is active.

Pause detector information is available at the PAUSE pin. A capacitor must be connected between the PAUSE pin and ground.

When the incoming signal is detected to be outside the selected window, the external capacitor is discharged. When the signal is inside the window, the capacitor is integrating up (see [Figure 15](#) and [Figure 16](#)).

- a) by reading directly the Pause pin level. The ON/OFF voltage threshold is 3.0V typical. Pause OFF = level low (< 3.0V) Pause ON = level high (> 3.0V)
- b) by reading via I2C bus the transmitted byte, bit PP = 0 pause active. P = 1 no pause detected. The external capacitor value fixes the time constant.

The pull up current is 25uV typical, with input signal

Vin = 1Vrms --; Vdc pin pause = 15mV

Vin = 0Vrms --; Vdc pin pause = 5.62V

For example choosing Cpause = 100nF the charge up constant is about 22ms. Instead with Cpause = 15nF the charge up constant is about 360µs.

The pause detection is useful in applications like RDS, to perform noiseless tuning frequency jumps, avoiding the use of the mute.

5.6 No symmetrical bass cut response

bit **D7 = 0** No symmetrical

bit **D7 = 1** Symmetrical

The bass stage has the option to generate an unsymmetrical response, for cut mode settings (bass level from -2db to -14dB)

For example using a T-type band pass external

The feature is useful for human ear equalization in a noisy environment, like a car.

See examples in [Figure 17](#) (symmetrical response) and [Figure 18](#) (unsymmetrical response).

5.7 Transmitted data (send mode)

bit **P = 0** Pause active

bit **P = 1** No pause detected

bit **ZM = 1** Zero cross mute ON

bit **ZM = 0** Zero cross mute OFF

bit **SM = 1** Soft mute ON

bit **SM = 0** Soft mute OFF

bit **ST = 1** Stereo signal detected (input MPX)

bit **ST = 0** Mono signal detected (input MPX)

The TDA7437N allows the reading of four info bits.

The type (stereo/mono) of received broadcasting signal is easily checked and displayed by using the **ST** bit.

The **P** bit check is useful in tuning jumps without signal muting.

The **SM** soft mute status becomes active immediately, when bit D0 is set to 1 (soft mute ON, MUTE byte) and not when the signal level has reached the 60 dB final attenuation.

5.8 TDA7437N I²C bus protocol

The protocol is standard I²C, using subaddress byte plus data bytes (as shown within [Chapter 4](#)).

The optional autoincrement mode allows to refresh all the bytes registers with transmission of a single subaddress, reducing drastically the total transmission time.

Without autoincrement, subaddress bit **I = 0**, to refresh all the bytes registers (10), it is necessary to transmit 10 times the chip address, the subaddress and the data byte.

Working with a 100Kb/s clock speed the total time would be :

$$[(9*3+2)*10]\text{bits}*10\text{us}=2.9\text{ms}$$

Instead using autoincrement mode, subaddress bit **I=1**, the total time will be:

$$(9*12+2)*10\text{us}=1.1\text{ms.}$$

The autoincrement mode is useful also to refresh partially the data. For example to refresh the 4 speakers attenuators it is possible to program the subaddress Spkr LF (code XX010100), followed by the data byte of SPKR LF, LR, RF, RR in sequence.

Note: that the autoincrement mode has a module 16 counter, whereas the total used register bytes are 10.

It is not correct to refresh all the 10 bytes starting from a subaddress different than XX010000.

For example, using subaddress XX010010 (volume), the registers from Volume to Mute (see [Table 5](#)) are correctly updated, but the next two transmitted bytes, refer instead to the wanted input selector, and Loudness are discharged. (the solution in this case is to send two separate patterns in autoincrement mode, the first composed by address, subaddress XX010010, 8 data bytes, and the second composed by address, subaddress XX010000, 2 data bytes).

With autoincrement disabled, the protocol allows the transmission in sequence of N data bytes of a specific register, without the necessity to resend the address and subaddress bytes, each time.

This feature can be implemented, for example, if a gradual volume change has to be performed (the MCU does not send the STOP condition, but keeps the TDA7437N communication active).

Warning: The TDA7437N always needs to receive a STOP condition, before beginning a new START condition. The device doesn't recognize a START condition if a previously active communication was not ended by a STOP condition.

5.9 I²C bus read mode

The TDA7437N sends the master a 1 byte "transmitted info" via I²C bus in read mode. The read mode is master activated by sending the chip address with LSB set to 1, followed by an acknowledge bit.

The TDA7437N recognizes the request. At the following master generated clock bits, the TDA7437N issues the transmitted info byte on the SDA data bus line (MSB transmitted first).

At the ninth clock bit the MCU master can:

- acknowledge the reception, starting in this way the transmission of another byte from the TDA7437N.
- no acknowledge, stopping the read mode communication.

5.10 Loudness stage

The previous SGS-THOMSON audioprocessors implemented a fixed loudness response, only ON/OFF sw programmable.

No possibility to change the loud boost rate at a certain volume level. The TDA7437N implements a fully programmable loudness control in 20 steps of 1dB.

It allows a customized loudness response for each application. The external network connected to the loudness pins LOUD_L and LOUD_R fixes the type of loudness response.

1. Simple capacitor. The loudness effect is only a boost of low frequencies. (see [Figure 19](#))
2. Second order loudness (boost of low and high frequencies).
3. Second order decreased type loudness (lower boost of low and high frequencies).
4. Second order modified type loudness (higher boost of low and high frequencies).

5.11 Treble stage

The treble stage is a simple high pass filter, its time constant is fixed by internal resistor (typically 50Kohm), and an external capacitor, connected between pins TREB_R/TREB_L and ground.

5.12 IN-OUT pins

The multiplexer output is available at OUT_R and OUT_L pins for the optional connection of an external graphic equalizer (TDA7316/TDA7317), surround chip (TDA7346) etc. The signal is fed in again at pins IN_L and IN_R. In the case of an application without any external devices, the pins OUT_L/OUT_R and IN_L/IN_R can be left unconnected, if bit D3 byte input selector is forced = 0 (DC connect). Instead if bit D3 is kept = 1 an external decoupling capacitor must be provided between OUTR/INR and OUTL/INR to avoid signal DC jumps, generating "clicking" output noise. The input impedance of the next volume stage is 44Kohm typical (minimum 31Kohm). A capacitor no lower than 1mF should be used.

5.13 Bass & mid filters

Several bass filter types can be implemented. Normally it is the basic T-type bandpass filter that is used. Starting from the filter component values (R1 internal and R2, C1, C2 external), the centre frequency F_c , the gain A_v at max bass boost and the filter Q factor are computed as follows:

$$F_c = \frac{1}{2 \cdot \Pi \cdot \sqrt{R1 \cdot R2 \cdot C1 \cdot C2}}$$

$$A_v = \frac{R2 \cdot C2 + R2 \cdot C1 + R1 \cdot C1}{R2 \cdot C1 + R2 \cdot C2}$$

Vice versa fixed F_c , A_v , and R1 (internal typ.±30%), the external component values are

$$C1 = \frac{A_v - 1}{2 \cdot \Pi \cdot R1 \cdot Q}$$

$$C2 = \frac{Q \cdot Q \cdot C1}{A_v - 1 - Q \cdot Q}$$

$$Q = \frac{\sqrt{(R1 \cdot R2 \cdot C1 \cdot C2)}}{R2 \cdot C1 + R2 \cdot C2}$$

$$R2 = \frac{A_v - 1 - Q \cdot Q}{2 \cdot \Pi \cdot C1 \cdot F_c \cdot (A_v - 1) \cdot Q}$$

5.14 Input selector

The multiplexer selector can choose one of the following inputs:

- a differential CD stereo input.
- a mono input.
- four stereo input

The signal fed to the input pins must be decoupled via series capacitors. The minimum allowed value depends on the correspondent input impedance. For the CD diff input ($Z_i = 10\text{Kohm}$ worst case) a $C_{in} = 4.7\mu\text{F}$ is recommended. For the other inputs (70Kohm worst case, a $C_{in}=1\mu\text{F}$ is recommended.

6 Curves of electrical characteristics

Figure 7. Power on time constant vs C_{REF} capacitor $C_{REF} = 4.7\mu F$

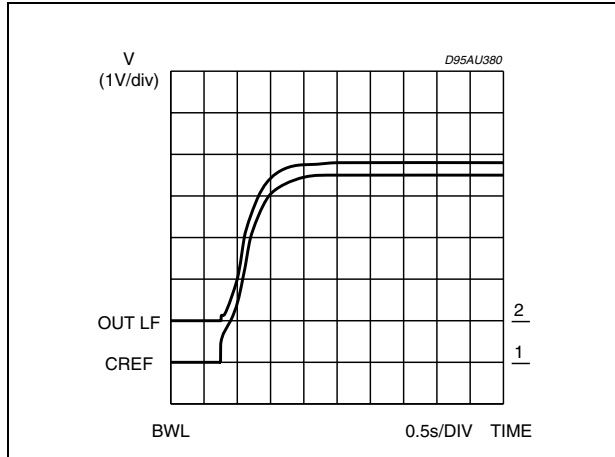

Figure 8. Power on time constant vs C_{REF} capacitor $C_{REF} = 10\mu F$

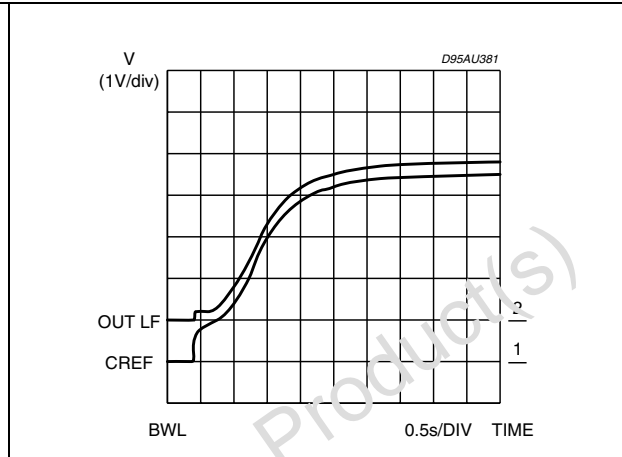

Figure 9. Power on time constant vs C_{REF} capacitor $C_{REF} = 22\mu F$

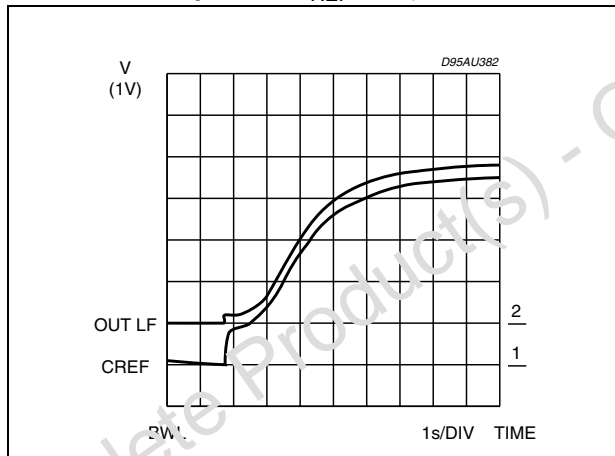

Figure 10. SVF_r vs. frequency

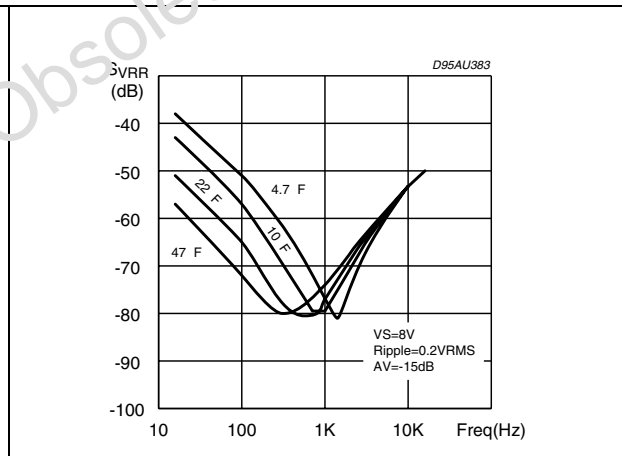

Figure 11. Soft mute ON

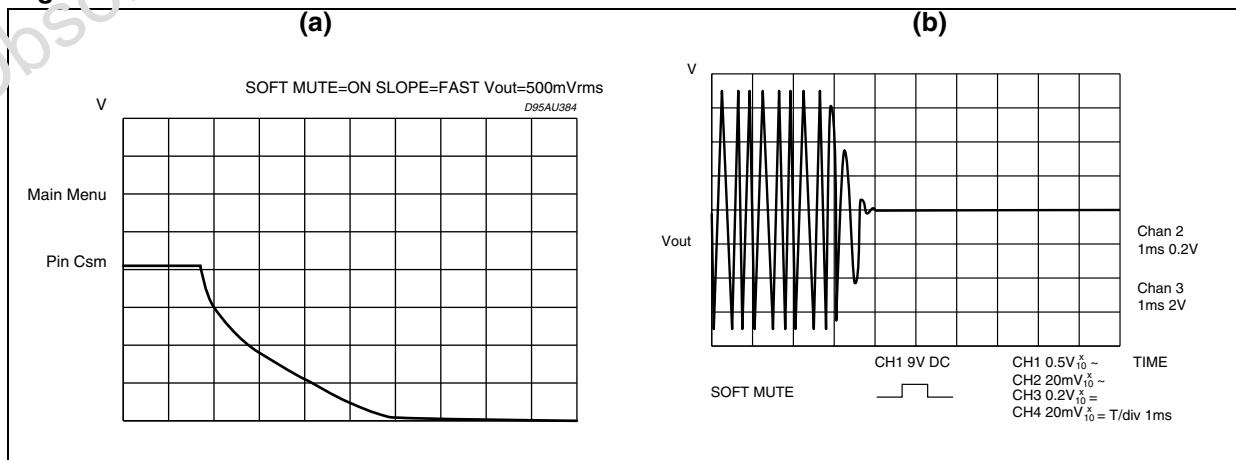

Figure 12. Soft mute OFF

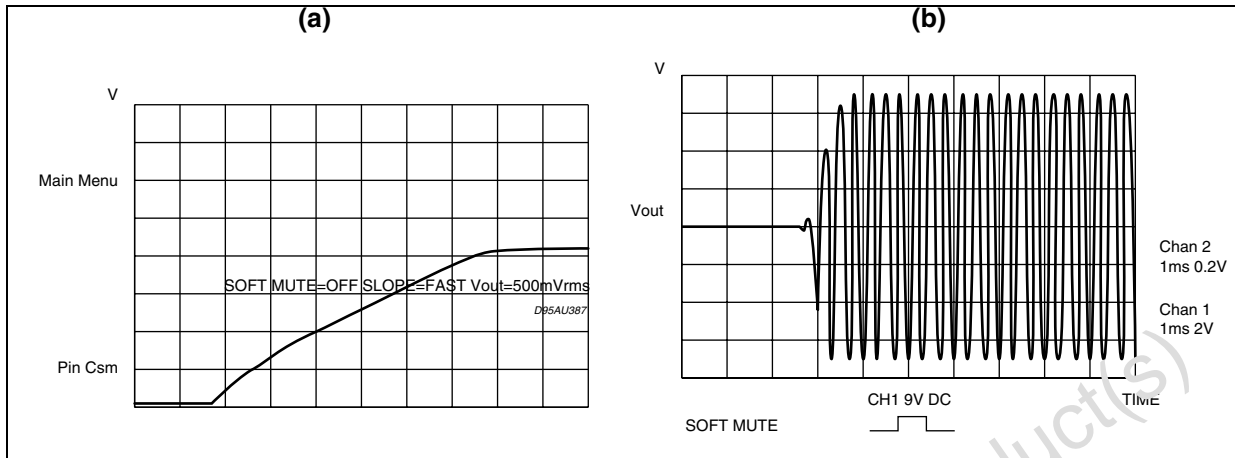

Figure 13. Zero crossing mute ON

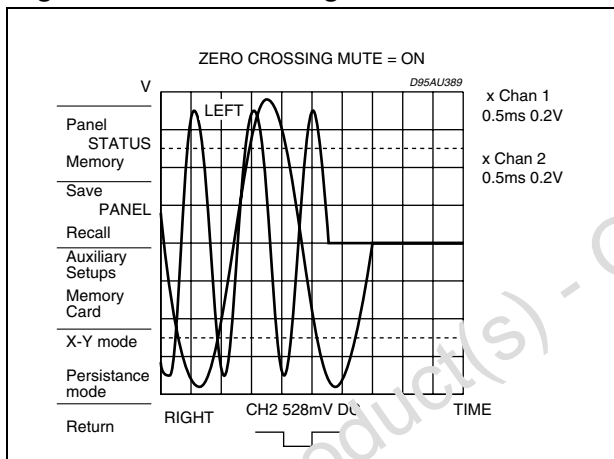

Figure 14. Zero crossing mute OFF

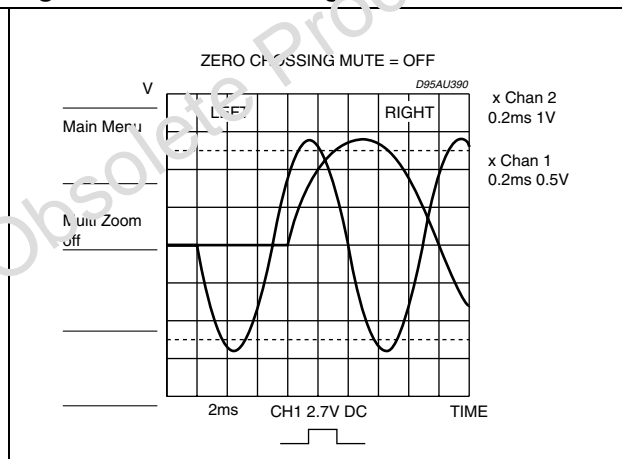

Figure 15. Pause detector

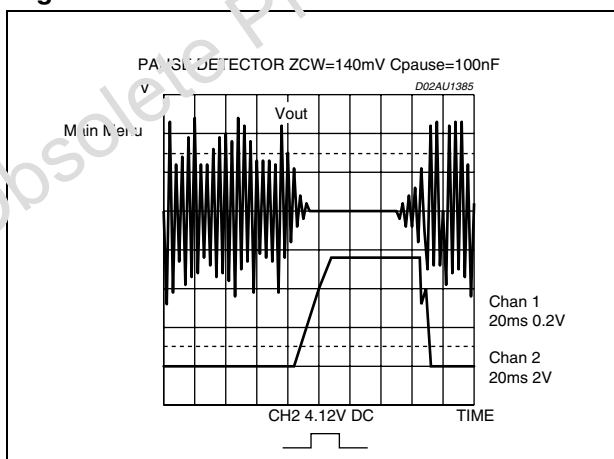

Figure 16. Pause detector

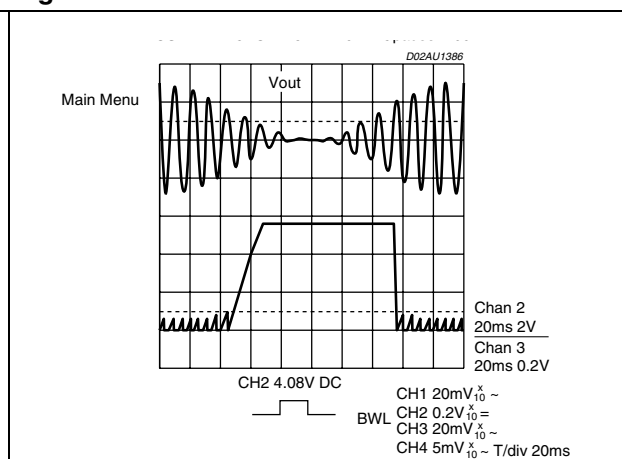

Figure 17. Symmetrical bass

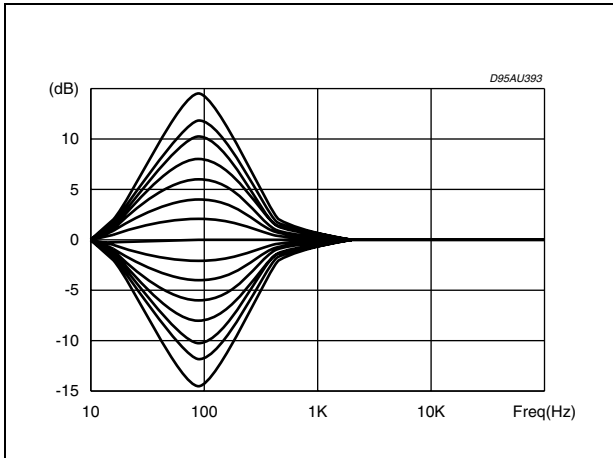

Figure 18. unsymmetrical bass

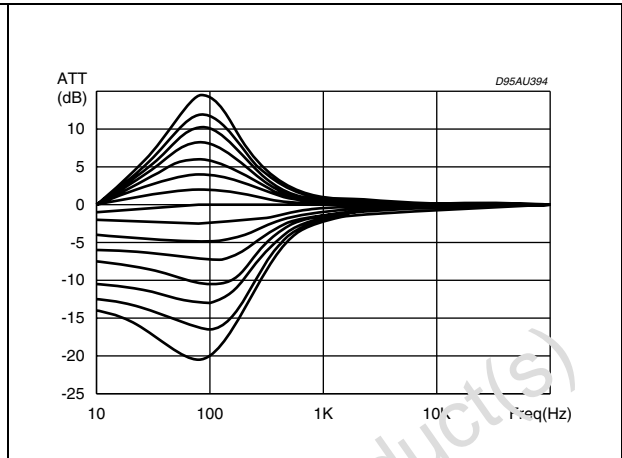
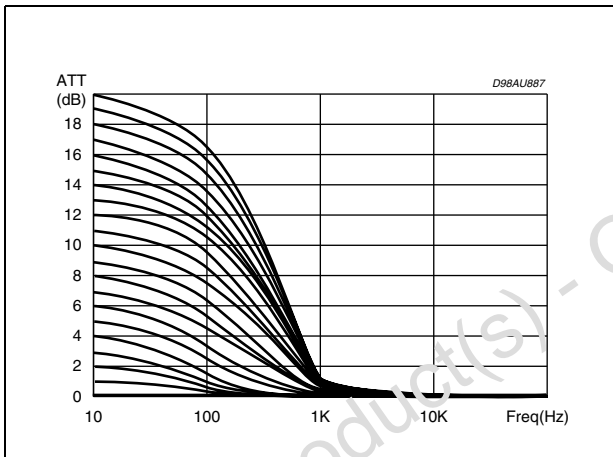
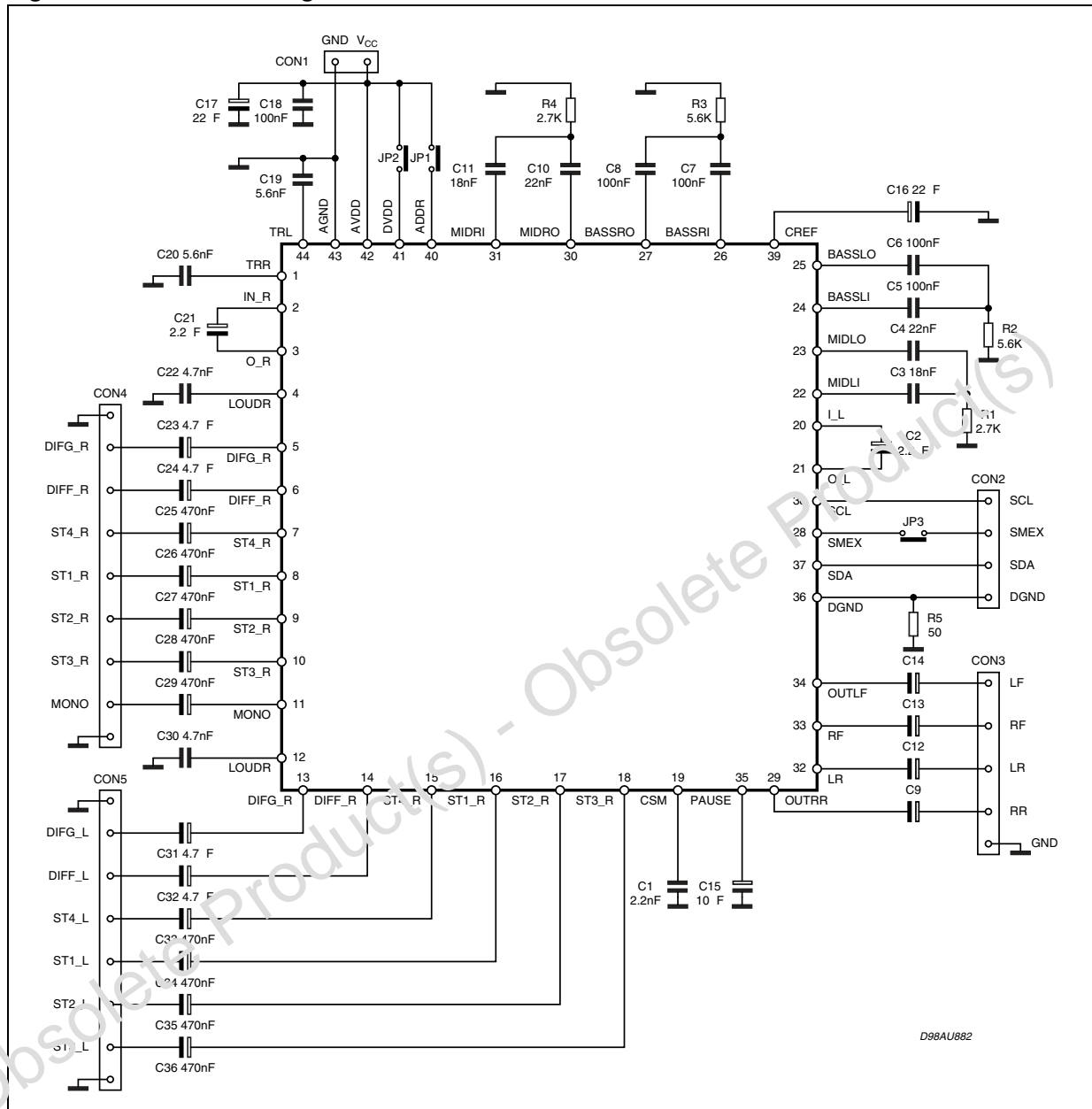

Figure 19. Loudness



Obsolete Product(s) - Obsolete Product(s)

Figure 20. Test board diagram



7 Package information

In order to meet environmental requirements, ST offers these devices in ECOPACK® packages. These packages have a lead-free second level interconnect. The category of second level interconnect is marked on the package and on the inner box label, in compliance with JEDEC standard JESD97. The maximum ratings related to soldering conditions are also marked on the inner box label.

ECOPACK is an ST trademark. ECOPACK specifications are available at: www.st.com.

Figure 21. LQFP44 (10x10) Mechanical data and package dimensions

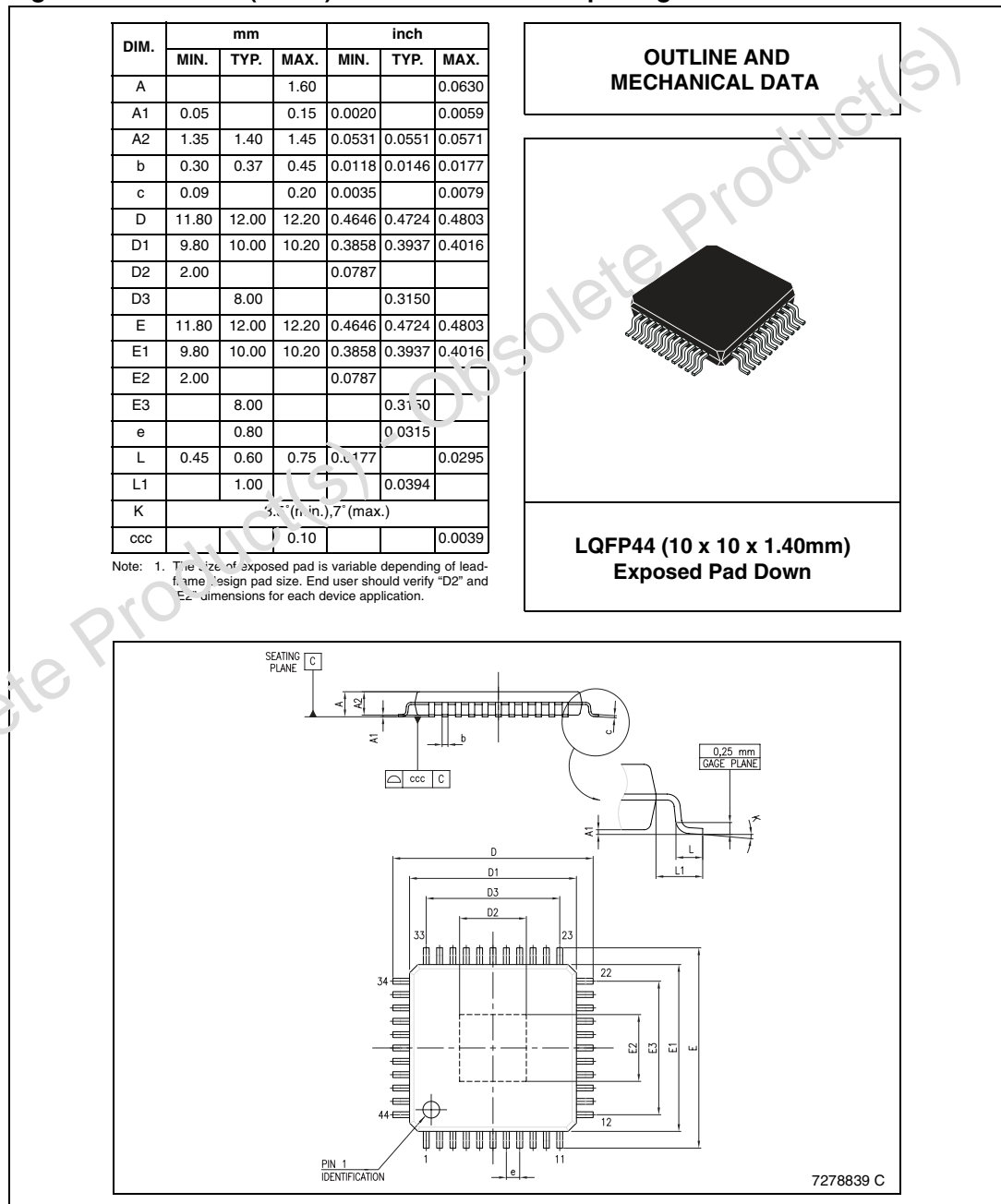

8 Revision history

Table 14. Document revision history

Date	Revision	Changes
24-Jan-06	1	Initial release.
01-Dec-06	2	Package changed, layout change, text modifications.

Obsolete Product(s) - Obsolete Product(s)

Please Read Carefully:

Information in this document is provided solely in connection with ST products. STMicroelectronics NV and its subsidiaries ("ST") reserve the right to make changes, corrections, modifications or improvements, to this document, and the products and services described herein at any time, without notice.

All ST products are sold pursuant to ST's terms and conditions of sale.

Purchasers are solely responsible for the choice, selection and use of the ST products and services described herein, and ST assumes no liability whatsoever relating to the choice, selection or use of the ST products and services described herein.

No license, express or implied, by estoppel or otherwise, to any intellectual property rights is granted under this document. If any part of this document refers to any third party products or services it shall not be deemed a license grant by ST for the use of such third party products or services, or any intellectual property contained therein or considered as a warranty covering the use in any manner whatsoever of such third party products or services or any intellectual property contained therein.

UNLESS OTHERWISE SET FORTH IN ST'S TERMS AND CONDITIONS OF SALE ST DISCLAIMS ANY EXPRESS OR IMPLIED WARRANTY WITH RESPECT TO THE USE AND/OR SALE OF ST PRODUCTS INCLUDING WITHOUT LIMITATION IMPLIED WARRANTIES OF MERCHANTABILITY, FITNESS FOR A PARTICULAR PURPOSE (AND THEIR EQUIVALENTS UNDER THE LAWS OF ANY JURISDICTION), OR INFRINGEMENT OF ANY PATENT, COPYRIGHT OR OTHER INTELLECTUAL PROPERTY RIGHT.

UNLESS EXPRESSLY APPROVED IN WRITING BY AN AUTHORIZED ST REPRESENTATIVE, ST PRODUCTS ARE NOT RECOMMENDED, AUTHORIZED OR WARRANTED FOR USE IN MILITARY, AIR CRAFT, SPACE, LIFE SAVING, OR LIFE SUSTAINING APPLICATIONS, NOR IN PRODUCTS OR SYSTEMS WHERE FAILURE OR MALFUNCTION MAY RESULT IN PERSONAL INJURY, DEATH, OR SEVERE PROPERTY OR ENVIRONMENTAL DAMAGE. ST PRODUCTS WHICH ARE NOT SPECIFIED AS "AUTOMOTIVE GRADE" MAY ONLY BE USED IN AUTOMOTIVE APPLICATIONS AT USER'S OWN RISK.

Resale of ST products with provisions different from the statements and/or technical features set forth in this document shall immediately void any warranty granted by ST for the ST product or service described herein and shall not create or extend in any manner whatsoever, any liability of ST.

ST and the ST logo are trademarks or registered trademarks of ST in various countries.

Information in this document supersedes and replaces all information previously supplied.

The ST logo is a registered trademark of STMicroelectronics. All other names are the property of their respective owners.

© 2006 STMicroelectronics - All rights reserved

STMicroelectronics group of companies

Australia - Belgium - Brazil - Canada - China - Czech Republic - Finland - France - Germany - Hong Kong - India - Israel - Italy - Japan - Malaysia - Malta - Morocco - Singapore - Spain - Sweden - Switzerland - United Kingdom - United States of America

www.st.com