

RGC1P..AA.., RGC1P..V..



1-pole proportional switching controllers with integrated heatsink



Description

The RGC1P is a series of solid state contactors (with integrated heatsink) that give the possibility to control output power of 1-phase loads with an analog control input.

Input types cover a wide range of current and voltage ranges. Local setting by an external potentiometer is possible. Switching modes, selectable through a front knob, allow phase angle control, full cycle control, advanced full cycle control specific for short wave infrared heaters and soft starting for limiting inrush current of loads having a high temperature coefficient.

The output of the RGC1P is protected against overvoltages by means of an integrated varistor across the output. Two front LEDs indicate the status of the load and control.

Specifications are at a surrounding temperature of 25°C unless otherwise specified.

Benefits

- **Eliminates the need for analog to digital convertors.** The output of the RGC1P can be controlled directly via an analog current or analog voltage signal.
- **Inventory reduction.** Multifunction controller with the possibility to select amongst a number of switching modes.
- **Less maintenance costs.** Wire bonding technology reduces thermal and mechanical stresses of the output chips resulting in a larger number of operational cycles compared to other assembly technologies.
- **Low machine downtime.** Integrated overvoltage protection prevents the solid state relay from breaking down due to uncontrolled transients that may occur on the lines.
- **Ease of use.** The RGC1P ready to use solution is provided with integrated heatsink thus eliminating the need for the user to calculate the size of heatsink needed for adequate thermal dissipation.
- **Fast wiring.** Power connections for models rated >30 A are equipped with terminals that can handle cables up to 25 mm² / AWG3 cables.
- **Accommodates UL508A requirements for Industrial Control Panels.** The RGC1P is certified as a listed product. All models carry a 100 kArms Short Circuit Current Rating.

Applications

Injection moulding, PET stretch blow moulding, thermoforming, electrical ovens, furnaces, climatic chambers, duct heating, air handling units.

Main features

- 1-pole analog switching AC solid state relays
- Selectable switching mode: phase angle, distributed full cycle(s), advanced full cycle, soft starting
- Ratings up to 660 VAC and 63 AAC
- Control inputs: 4-20 mA or 0-5 V, 1-5 V, 0-10 V, external potentiometer

Order code

RGC1P **E**

 Enter the code option instead of . Refer to the selection guide section for valid part numbers.

Code	Option	Description	Comments
R	-	Solid State Relay (RG)	
G	-		
C	-	With integrated heatsink	
1	-	1-pole switching	
P	-	Proportional switching	
<input type="checkbox"/>	23	Rated voltage: 85 - 265 VAC, 800 Vp	
	48	Rated voltage: 190 - 550 VAC, 1200 Vp	
	60	Rated voltage: 410 - 660 VAC, 1200 Vp	
<input type="checkbox"/>	AA	Control input: 4-20 mADC	
	V	Control input: 0-5 VDC, 1- 5 VDC, 0-10 VDC, external potentiometer	Requires external supply (Us)
<input type="checkbox"/>	12	Rated current: 15 AAC (1800 A ² s)	
	30	Rated current: 30 AAC (1800 A ² s)	
	42	Rated current: 43 AAC (18000 A ² s)	
	50	Rated current: 50 AAC (3200 A ² s)	
	62	Rated current: 63 AAC (18000 A ² s)	
E	-	Contact configuration	
<input type="checkbox"/>	D	External power supply (Us): 24 VDC/AC	
	A	External power supply (Us): 90 - 250 VAC	
<input type="checkbox"/>	-		
	T	Tamper proof cover & secureness tie included in packaging	

Selection guide

Rated voltage, Ue	Control input	External Supply, Us	Power connection	Rated operational current @ 40°C				
				15 AAC (1800 A²s)	30 AAC (1800 A²s)	43 AAC (18000A²s)	50 AAC (3200 A²s)	63 AAC (18000 A²s)
				Product width				
				35 mm	35 mm	35 mm	70 mm	70 mm
85 - 265 VAC	AA: 4-20 mA DC	-	Screw	RGC1P23AA12E	RGC1P23AA30E	-	-	-
			Box	-	-	RGC1P23AA42E RGC1P23AA42ET	RGC1P23AA50E	RGC1P23AA62E
	V: 0-10V, 0-5V, 1-5VDC, pot	24 VDC/AC	Screw	RGC1P23V12ED	RGC1P23V30ED	-	-	-
			Box	-	-	RGC1P23V42ED RGC1P23V42EDT	RGC1P23V50ED	RGC1P23V62ED
		90-250 VAC	Screw	RGC1P23V12EA	RGC1P23V30EA	-	-	-
			Box	-	-	RGC1P23V42EA	-	RGC1P23V62EA
190 - 550 VAC	AA: 4-20 mA DC	-	Screw	RGC1P48AA12E	RGC1P48AA30E	-	-	-
			Box	-	-	RGC1P48AA42E RGC1P48AA42ET	RGC1P48AA50E	RGC1P48AA62E
	V: 0-10V, 0-5V, 1-5VDC, pot	24 VDC/AC	Screw	RGC1P48V12ED	RGC1P48V30ED	-	-	-
			Box	-	-	RGC1P48V42ED	RGC1P48V50ED	RGC1P48V62ED
		90-250 VAC	Screw	RGC1P48V12EA	RGC1P48V30EA	-	-	-
			Box	-	-	RGC1P48V42EA	-	RGC1P48V62EA
410 - 660 VAC	AA: 4-20 mA DC	-	Screw	-	RGC1P60AA30E	-	-	-
			Box	-	-	RGC1P60AA42E	-	RGC1P60AA62E
	V: 0-10V, 0-5V, 1-5VDC, pot	24 VDC/AC	Screw	-	RGC1P60V30ED	-	-	-
			Box	-	-	RGC1P60V42ED	-	RGC1P60V62ED
		90-250 VAC	Screw	-	RGC1P60V30EA	-	-	-
			Box	-	-	RGC1P60V42EA	-	RGC1P60V62EA

Carlo Gavazzi compatible components

Description	Component code	Notes
Protection cover	RGTMP	Tamper proof accessory kit containing: - 5 x transparent covers - 5 x secureness ties

Carlo Gavazzi further reading

Information	Where to find it	Notes
Datasheet	http://cga.pub/?39eb59	Heatsink and accessories range overview

Structure

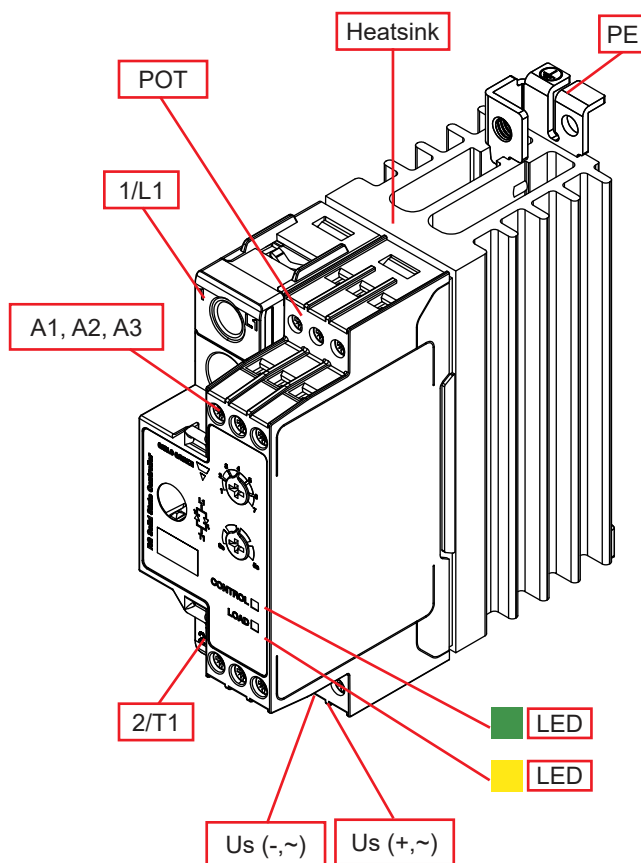

Element	Component	Function
1/L1	Power connection	Mains connection
2/T1	Power connection	Load connection
A1, A2, A3	Control connection	Control input
POT	Potentiometer connection	External potentiometer input
Us (+,~)	External supply connection	Positive signal (RGC1P..V..D) or AC signal (RGC1P..V..A)
Us (-,~)	External supply connection	Ground (RGC1P..V..D) or AC signal (RGC1P..V..A)
Green LED	Control indicator	Indicates presence of control voltage
Yellow LED	Load indicator	Indicates presence of load voltage
Heatsink	Integrated heatsink	DIN rail mounting (panel mounting also possible)
PE	Protective Earth	Connection for Protective Earth, PE screw not provided with RGC1P

Features

General data

Material	PA66 or PA6 (UL94 V0), RAL7035 Glow wire ignition temperature and Glow wire flammability index conform to EN 60335-1 requirements		
Mounting	DIN rail (panel mount also possible)		
Touch protection	IP20		
Overvoltage category	III, 6 kV (1.2/50 μ s) rated impulse withstand voltage		
Isolation	4000 Vrms (L1, T1, A1, A2, A3, POT, GND, Us to case)		
	2500 Vrms (L1, T1 to A1, A2, A3, POT, GND, Us)		
	1500 Vrms (Us to A1, A2, A3, POT, GND) applicable only for RGC1P..V..EA		
LED status indication¹	Green	RGC1P..AA.. Control input: <4 mA, flashing 0.5 s ON, 0.5 s OFF >4 mA, intensity varies with input Supply ON (Us): n/a	RGC1P..V.. Control input: <0 V, flashing 0.5 s ON, 0.5 s OFF >0 V, fully ON Supply ON (Us): Flashing 0.5 s ON, 0.5 s OFF
	Yellow	Load ON	
Weight	RGC1P..12:	approx. 225 g	
	RGC1P..30, 42:	approx. 460 g	
	RGC1P..50, 62:	approx. 815 g	

1. Refer to LED indicators section

Performance

Output specifications

	RGC1P..12	RGC1P..30	RGC1P..42	RGC1P..50	RGC1P..62
Max. operational current ² : AC-51 @ Ta=25 °C	18 AAC	30 AAC	50 AAC	58 AAC	73 AAC
Max. operational current ² : AC-51 @ Ta=40 °C	15 AAC	30 AAC	43 AAC	50 AAC	63 AAC
Max. operational current ³ : AC-55b @ Ta=40 °C	15 AAC	30 AAC	43 AAC	50 AAC	63 AAC
Operational frequency range	45 to 65 Hz				
Output protection	Integrated varistor				
Leakage current @ rated voltage	<5 mAAC				
Minimum operational current	250 mAAC	250 mAAC	500 mAAC	500 mAAC	500 mAAC
Repetitive overload current UL508: Ta=40°C, t _{ON} =1 s, t _{OFF} =9 s, 50 cycles, PF = 0.7	51 AAC	84 AAC	126 AAC	126 AAC	168 AAC
Non-repetitive surge current (I _{TSM}), t=10 ms	600 Ap	600 Ap	1900 Ap	800 Ap	1900 Ap
I ² t for fusing (t=10 ms), minimum	1800 A ² s	1800 A ² s	18000 A ² s	3200 A ² s	18000 A ² s
No. of starts ³	500	15	200	6	350
Power factor	>0.7 at rated voltage				
Critical dV/dt (@T _j init = 40°C)	1000 V/μs				

2. Refer to Current derating

3. Overload profile for AC-55b, I_e: AC-55b: 6x I_e - 0.2: 50 - x; where I_e = nominal current (AAC), 0.2 is the duration of the overload (6xI_e) in seconds, 50 is the duty cycle in %, and x = no. of starts. The overload profile for RGC1P..62 is AC-55b:4.7xI_e - 0.2 : 50-x

Output voltage specifications

	RGC1P23..	RGC1P48..	RGC1P60..
Operational voltage range (U _e)	85-265 VAC	190-550 VAC	410-660 VAC
Blocking voltage	800 Vp	1200 Vp	1200 Vp

Supply specifications

	RGC1P..V..D	RGC1P..V..A
Supply voltage range (U _s) ⁴	24 VDC, -15% / +20% 24 VAC, -15% / +15%	90-250 VAC -
Overvoltage protection	Up to 32 VDC/AC for 30 sec.	n/a
Reverse protection	Yes	n/a
Surge protection ⁵	Yes, integrated	Yes, integrated
Max. supply current	30 mA	14 mA

4. 24 VDC/AC to be supplied from a Class 2 power source

5. Refer to Electromagnetic Compatibility section



Input specifications

	RGC1P..AA..	RGC1P..V..
Control input	4-20 mADC (A1-A2)	0-10 VDC (A1-GND) 0-5 VDC (A2-GND) 1-5 VDC (A3-GND)
Pickup current	4.3 mADC	-
Drop out current	3.9 mADC	-
Pick-up voltage 0-5 VDC, 0-10 VDC range 1-5 VDC range	- -	0.5 VDC 1.5 VDC
Drop out voltage 0-5 VDC, 0-10 VDC range 1-5 VDC range	- -	0.05 VDC 1.02 VDC
Potentiometer input	-	10 kΩ (GND - A2 - POT)
Maximum initialisation time	280 ms	250 ms
Response time (input to output) Modes 1, 5, 7 Modes 2, 3, 4, 6	2 half cycles 3 half cycles	
Voltage drop	<10 VDC @ 20 mA	n/a
Input impedance	n/a	100 kΩ
Linearity (output resolution)	Refer to Transfer characteristics section ⁶	
Reverse protection	Yes	
Maximum allowable input current	50 mA for max. 30 sec	-
Input protection vs. surges⁷	Yes	
Overvoltage protection	-	up to 30 VDC

6. The RGx1P is intended for use in closed loop systems where the output power automatically adjusts to the control input available from the system.

7. Refer to Electromagnetic Compatibility section.

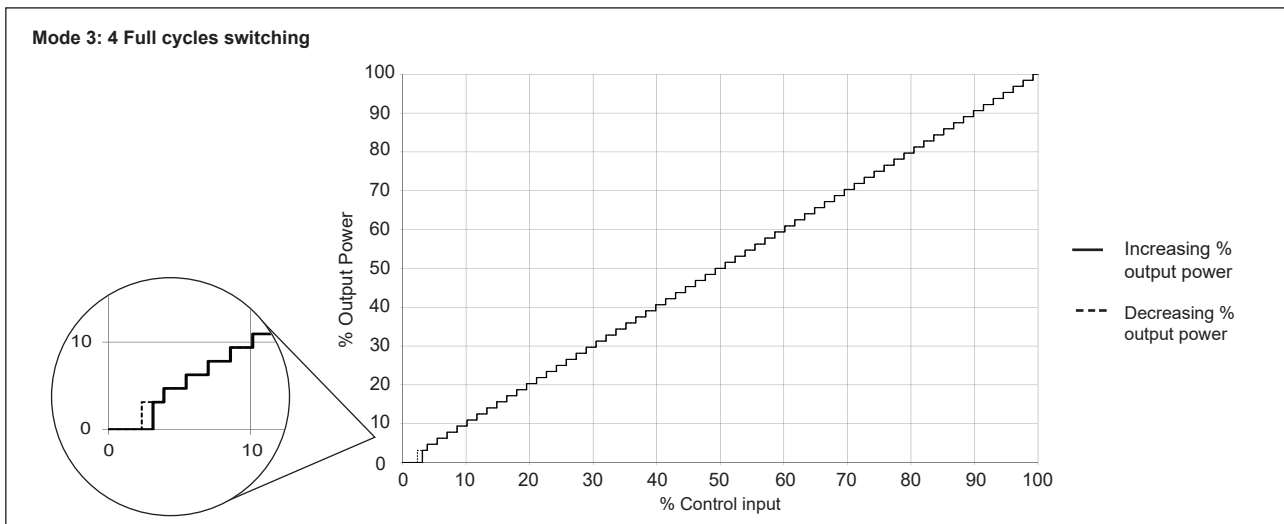
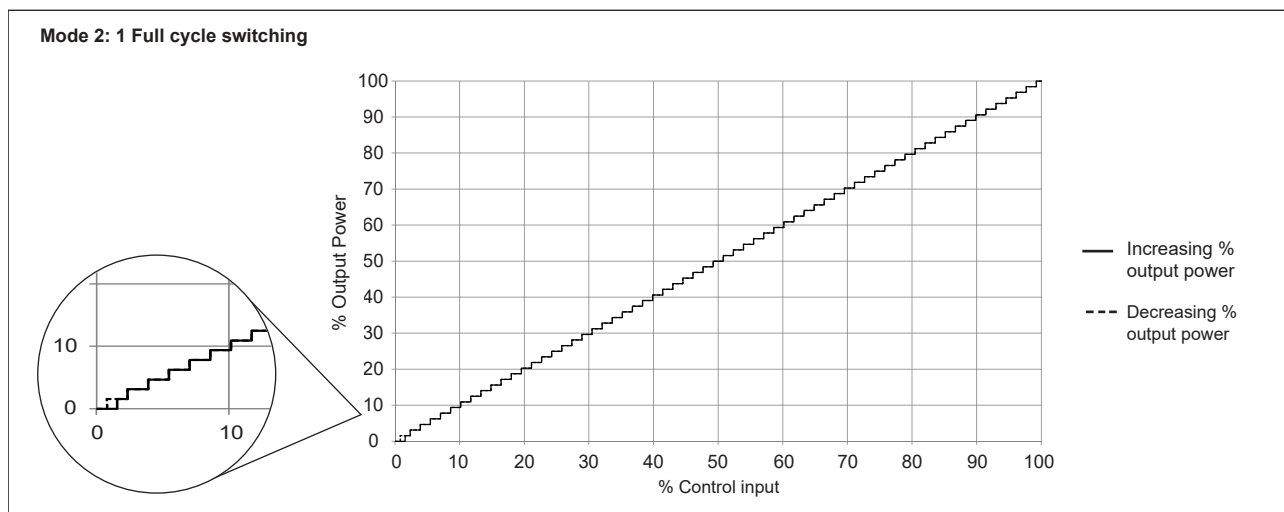
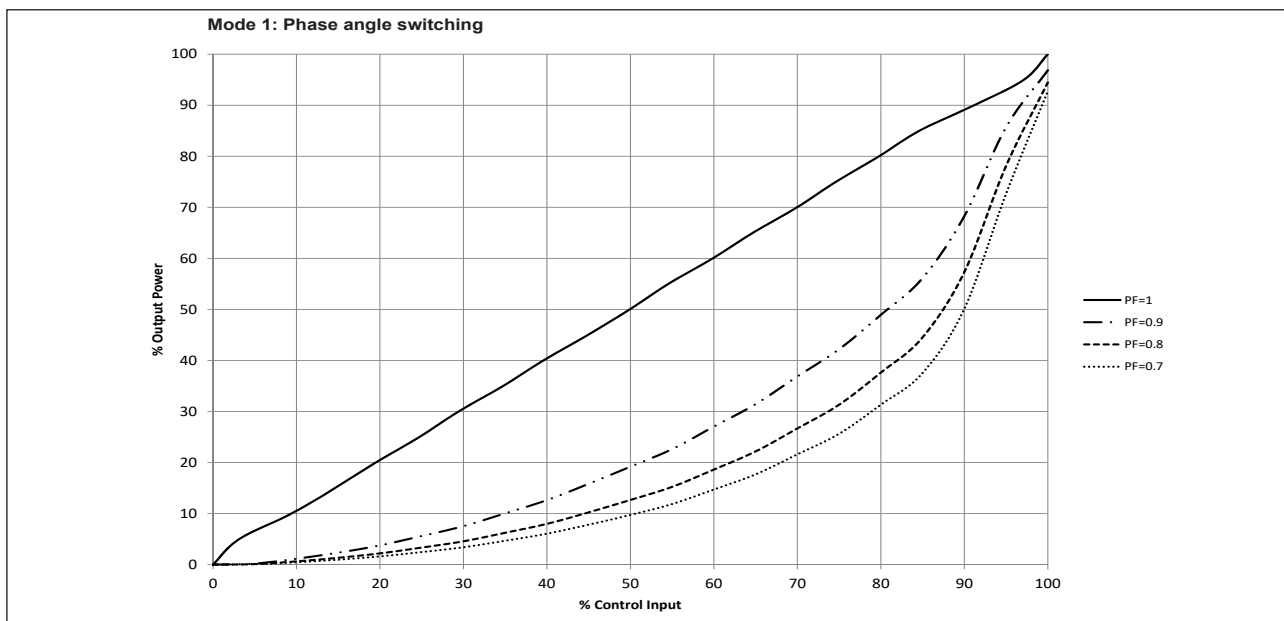
Transfer characteristics



▶ Transfer characteristics (continued)

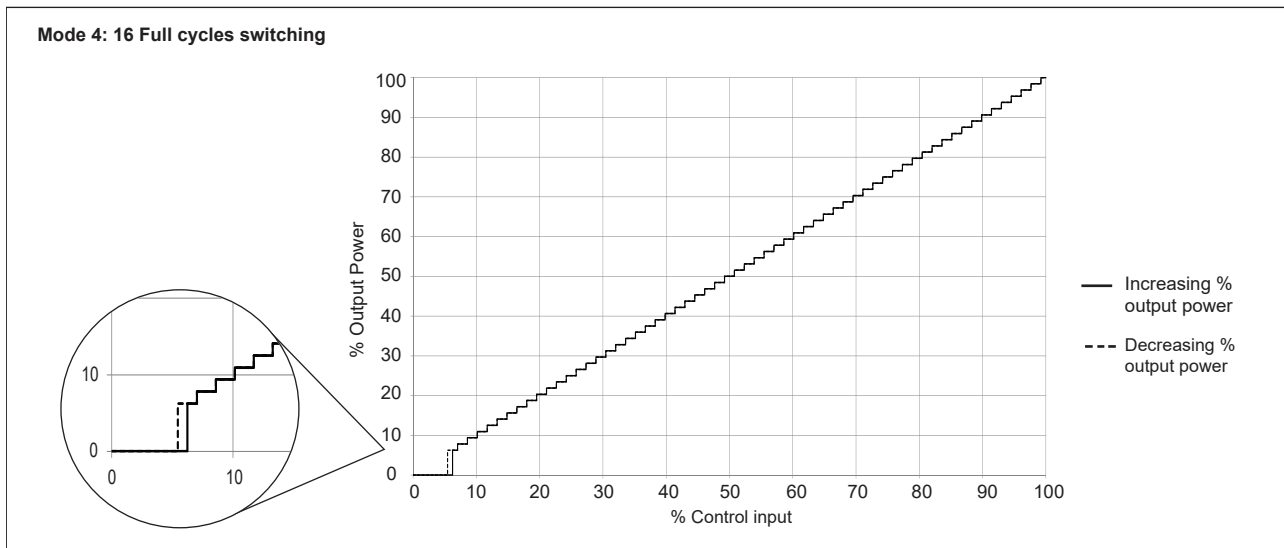

▶ Output power dissipation

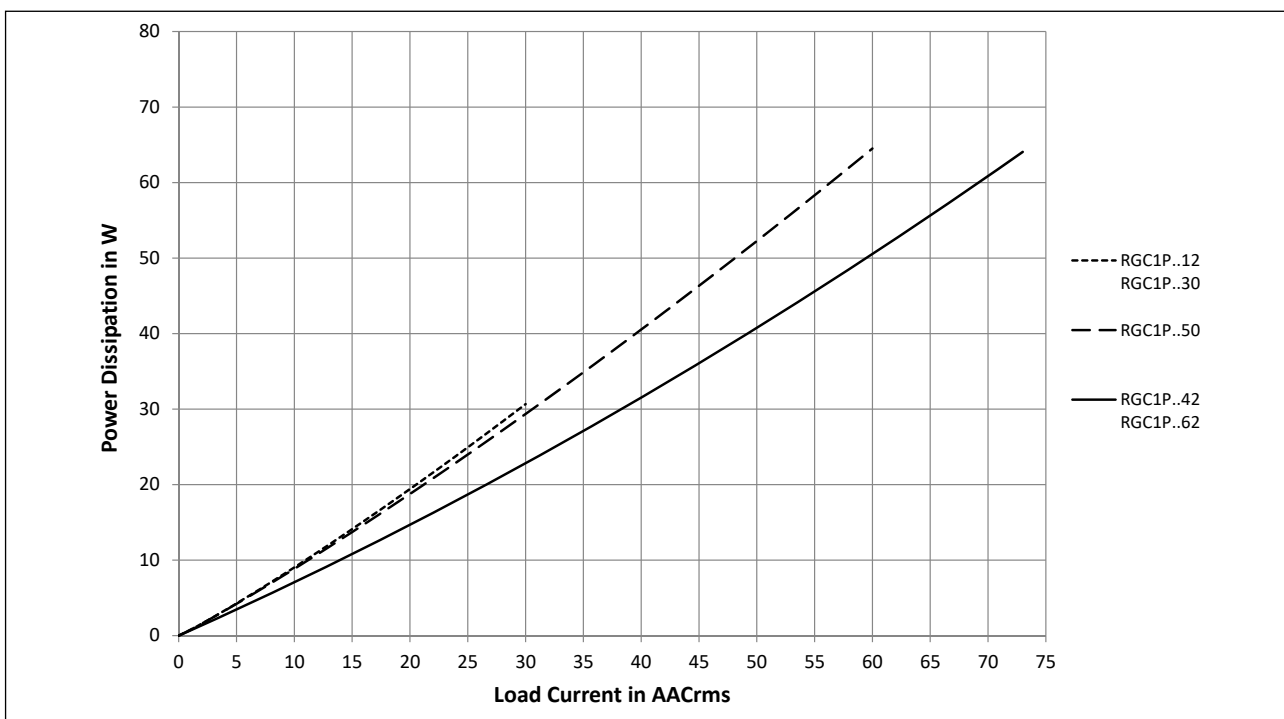

Current derating

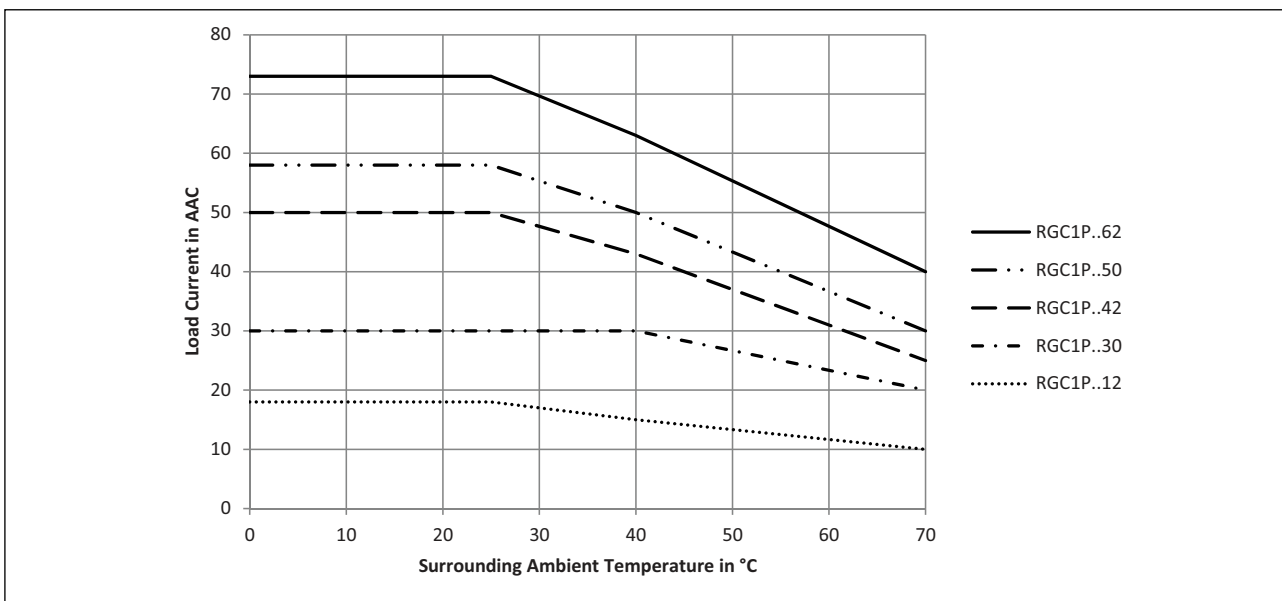



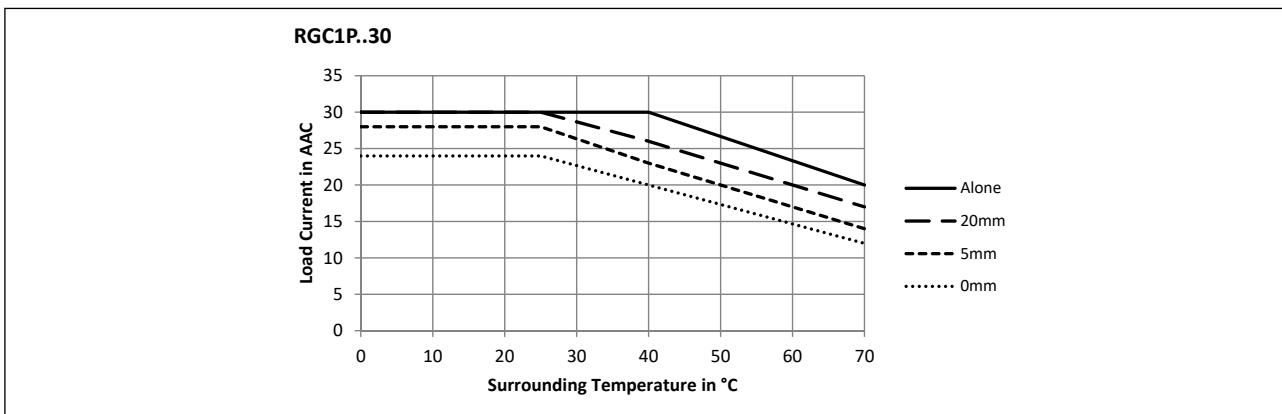
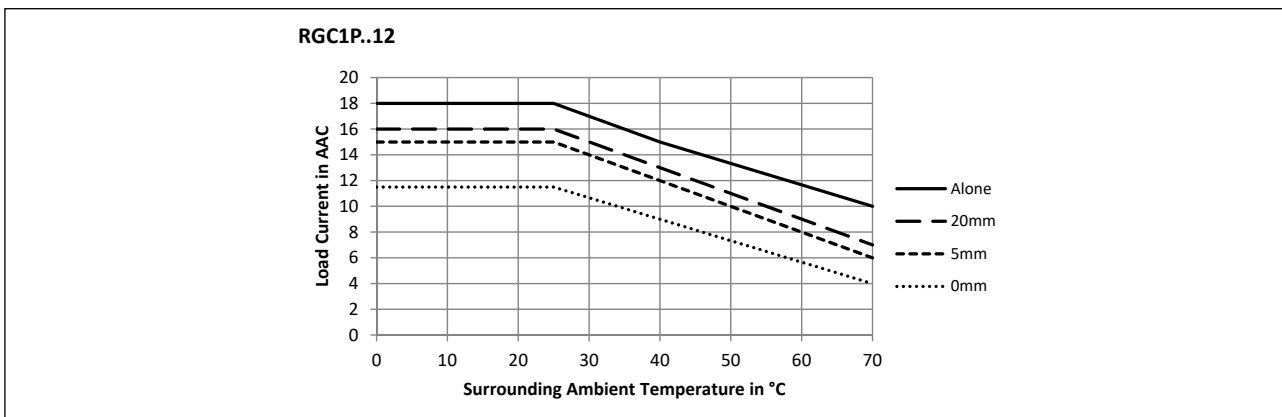

Derating vs. spacing curves

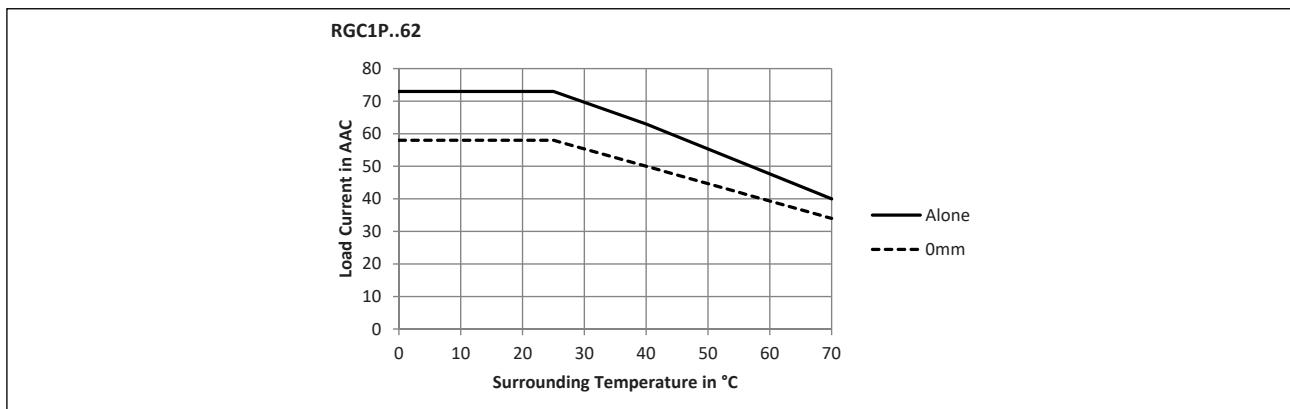
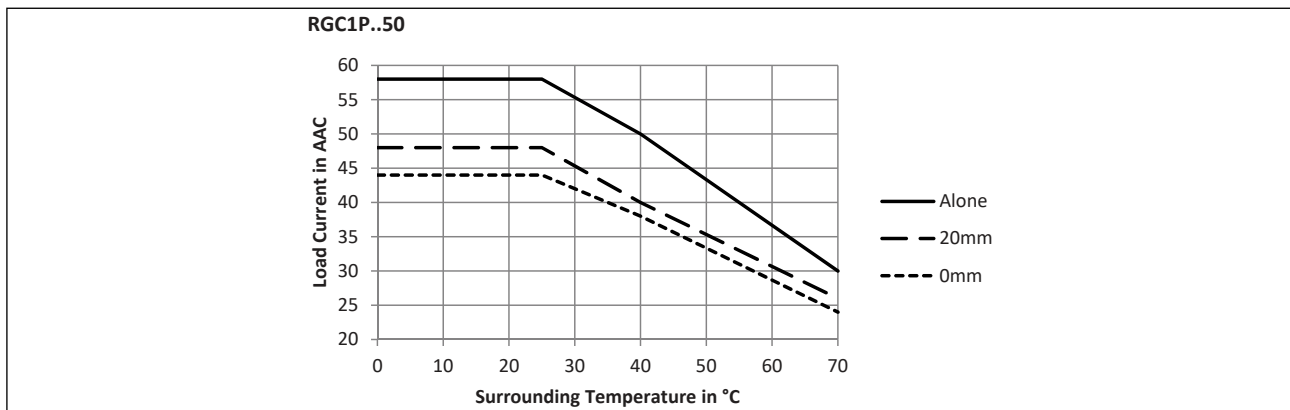
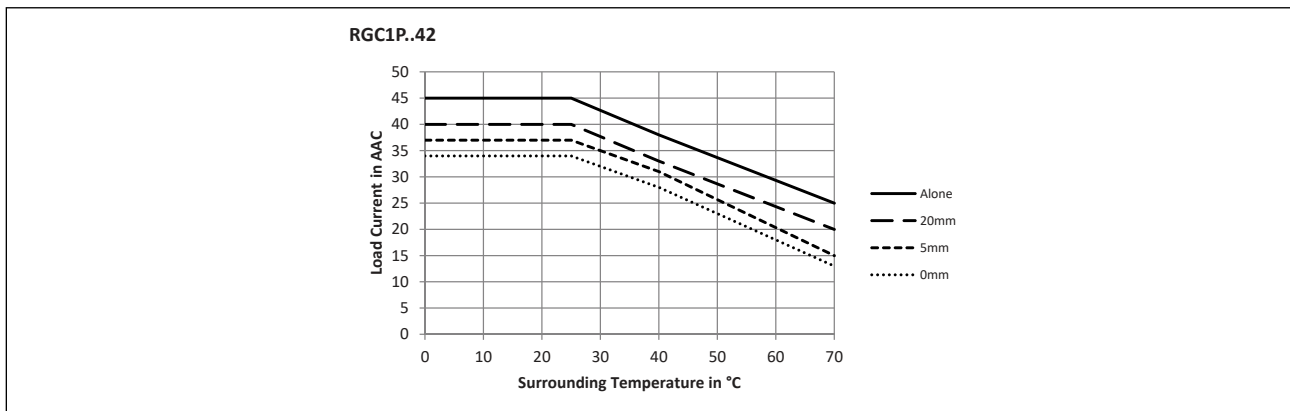

Derating vs. spacing curves (continued)



Compatibility and conformance

Approvals	   
Standards compliance	LVD: EN 60947-4-3 EMCD: EN 60947-4-3 EE: EN 60947-4-3 EMC: EN 60947-4-3 UL: UL508 (E172877), NMFT cUL: C22.2 No. 14 (E172877), NMFT7
UL short circuit current rating	100k Arms (refer to short circuit current section, Type 1 – UL508)

Electromagnetic compatibility (EMC) - Immunity	
Electrostatic discharge (ESD)	EN/IEC 61000-4-2 8 kV air discharge, 4 kV contact (PC2)
Radiated radio frequency	EN/IEC 61000-4-3 10 V/m, from 80 MHz to 1 GHz (PC1) 10 V/m, from 1.4 to 2 GHz (PC1) 3 V/m, from 2 to 2.7 GHz (PC1)
Electrical fast transient (burst)	EN/IEC 61000-4-4 Output: 2 kV, 5 kHz (PC1)
RGC1P..AA.. A1, A2	2 kV, 5 kHz (PC1)
RGC1P..V.. A1, A2, A3, POT, GND Us	1 kV, 5 kHz (PC1) 2 kV, 5 kHz (PC1)
Conducted radio frequency	EN/IEC 61000-4-6 10 V/m, from 0.15 to 80 MHz (PC1)
Electrical surge	EN/IEC 61000-4-5 Output, line to line: 1 kV (PC2) Output, line to earth: 2 kV (PC2)
RGC1P..AA.. A1, A2	Line to line, 500 V (PC2) Line to earth, 500 V (PC2)
RGC1P..V.. A1, A2, A3, POT, GND	Line to earth, 1 kV (PC2)
RGC1P..V..ED Us +, Us -	Line to line, 500 V (PC2) Line to earth, 500 V (PC2)
RGC1P..V..EA Us ~	Line to line, 1 kV (PC2) Line to earth, 2 kV (PC2)
Voltage dips	EN/IEC 61000-4-11 0% for 0.5, 1 cycle (PC2) 40% for 10 cycles (PC2) 70% for 25 cycles (PC2) 80% for 250 cycles (PC2)
Voltage interruptions	EN/IEC 61000-4-11 0% for 5000 ms (PC2)

Electromagnetic compatibility (EMC) - Emissions	
Radio interference field emission (radiated)	EN/IEC 55011 Class A: from 30 to 1000 MHz
Radio interference voltage emissions (conducted)	EN/IEC 55011 Class A: from 0.15 to 30 MHz (External filter may be required - refer to Filtering section)

- Control input lines must be installed together to maintain products' susceptibility to Radio Frequency interference.
- Use of AC Solid State Relays may, according to the application and the load current, cause conducted radio interferences. Use of mains filters may be necessary for cases where the user must meet E.M.C requirements. The capacitor values given inside the filtering specification tables should be taken only as indications, the filter attenuation will depend on the final application.
- Surge tests on RG..A were carried out with the signal line impedance network. In case the line impedance is less than 40Ω, it is suggested that AC supply is provided through a secondary circuit where the short circuit limit between conductors and ground is 1500VA or less.
- A deviation of one step in the distributed full cycle models and up to 1.5% Full Scale Deviation in phase angle models is considered to be within PC1 criteria.
- Performance Criteria 1 (PC1): No degradation of performance or loss of function is allowed when the product is operated as intended.
- Performance Criteria 2 (PC2): During the test, degradation of performance or partial loss of function is allowed. However when the test is complete the product should return operating as intended by itself.
- Performance Criteria 3 (PC3): Temporary loss of function is allowed, provided the function can be restored by manual operation of the controls.

Filtering - EN/IEC 55011 compliance
Compliance to Class A emission limits

	RGC1P..12	RGC1P..30	RGC1P..42	RGC1P..50	RGC1P..62
Max. load current	15 AAC	30 AAC	43 AAC	50 AAC	60 AAC
Mode 1 - phase angle	SCHURTER: 5500.2218 ROXBURGH: RES90F16, RES90F20	SCHAFFNER: FN2410-45-33 EPCOS: SIFI-H-G136	SCHAFFNER: FN2410-45-33 EPCOS: A50R000, A42R122, SIFI-H-G136 (up to 36 A)	SCHAFFNER: FN2410-60-34 EPCOS: A50R000	SCHAFFNER: FN2410-60-34
Mode 2 -1x full cycle	1.0uF / 760 VAC / X1	2.2uF / 760 VAC / X1	3.3uF / 760 VAC / X1	3.3uF / 760 VAC / X1	3.3uF / 760 VAC / X1
Mode 3 - 4x full cycles	680nF / 760 VAC / X1	1uF / 760 VAC / X1	2.2uF / 760 VAC / X1	2.2uF / 760 VAC / X1	2.2uF / 760 VAC / X1
Mode 4 - 16x full cycles	330nF / 760 VAC / X1	680nF / 760 VAC / X1	1uF / 760 VAC / X1	1uF / 760 VAC / X1	2.2uF / 760 VAC / X1
Mode 5 - advanced full cycle	1.0uF / 760 VAC / X1	3.3uF / 760 VAC / X1	3.3uF / 760 VAC / X1	3.3uF / 760 VAC / X1	SCHAFFNER: FN2410-60-34 EPCOS: A60R000
Mode 6 - Soft start + Mode 4	330nF / 760 VAC / X1	680nF / 760 VAC / X1	1uF / 760 VAC / X1	1uF / 760 VAC / X1	2.2uF / 760 VAC / X1
Mode 7 - Soft start + Mode 5	1.0uF / 760 VAC / X1	3.3uF / 760 VAC / X1	3.3uF / 760 VAC / X1	3.3uF / 760 VAC / X1	SCHAFFNER: FN2410-60-34 EPCOS: A60R000

Compliance to Class B emission limits

	RGC1P..12	RGC1P..30	RGC1P..42	RGC1P..50	RGC1P..62
Max. load current	15 AAC	30 AAC	43 AAC	50 AAC	60 AAC
Mode 1 - phase angle	SCHURTER: 5500.2069 (up to 12A) EPCOS: SIFI-H-G120 B12R000 (up to 12 A)	EPCOS: A42R122	EPCOS: A55R122	EPCOS: A55R122	EPCOS: A75R122
Mode 2 -1x full cycle	3.3uF / 760 VAC / X1	SCHAFFNER: FN2410-45-33 EPCOS: SIFI-H-G136	SCHAFFNER: FN2410-45-33 EPCOS: A50R000, A42R122, SIFI-H-G136 (up to 36 A) ROXBURGH: MDF50	SCHAFFNER: FN2410-60-34 EPCOS: A55R122, A42R122, (up to 42 A) ROXBURGH: MDF50	SCHAFFNER: FN2410-60-34 EPCOS: A60R000
Mode 3 - 4x full cycles	2.2uF / 760 VAC / X1	3.3uF / 760 VAC / X1	3.3uF / 760 VAC / X1	SCHAFFNER: FN2410-60-34 EPCOS: A55R122, A42R122, (up to 42 A)	SCHAFFNER: FN2410-60-34 EPCOS: A60R000
Mode 4 - 16x full cycles	1.0uF / 760 VAC / X1	2.2uF / 760 VAC / X1	2.2uF / 760 VAC / X1	3.3uF / 760 VAC / X1	3.3uF / 760 VAC / X1
Mode 5 - advanced full cycle	SCHURTER: 5500.2218 ROXBURGH: RES90F16, RES90F20	SCHAFFNER: FN2410-45-33 EPCOS: SIFI-H-G136	SCHAFFNER: FN2410-45-33 EPCOS: A50R000, A42R122, SIFI-H-G136 (up to 36 A) ROXBURGH: MDF50	SCHAFFNER: FN2410-60-34 EPCOS: A55R122, A42R122, (up to 42 A) ROXBURGH: MDF50	SCHAFFNER: FN2410-60-34 EPCOS: A60R000
Mode 6 - Soft start + Mode 4	1.0uF / 760 VAC / X1	2.2uF / 760 VAC / X1	2.2uF / 760 VAC / X1	3.3uF / 760 VAC / X1	3.3uF / 760 VAC / X1
Mode 7 - Soft start + Mode 5	SCHURTER: 5500.2218 ROXBURGH: RES90F16, RES90F20	SCHAFFNER: FN2410-45-33 EPCOS: SIFI-H-G136	SCHAFFNER: FN2410-45-33 EPCOS: A50R000, A42R122, SIFI-H-G136 (up to 36 A) ROXBURGH: MDF50	SCHAFFNER: FN2410-60-34 EPCOS: A55R122, A42R122, (up to 42 A) ROXBURGH: MDF50	SCHAFFNER: FN2410-60-34 EPCOS: A60R000

Note: The suggested filtering is determined by tests carried out on a representative setup and load. The RGC1P.. is intended to be integrated within a system where conditions may differentiate from conditions utilised for tests, such as load, cable lengths and other auxiliary components that may exist within the end system. It shall be the responsibility of the system integrator to ensure that the system containing the above component complies with the applicable rules and regulations.

Filter manufacturer installation recommendations shall be taken in consideration when utilising such filters.

Filter connection diagram

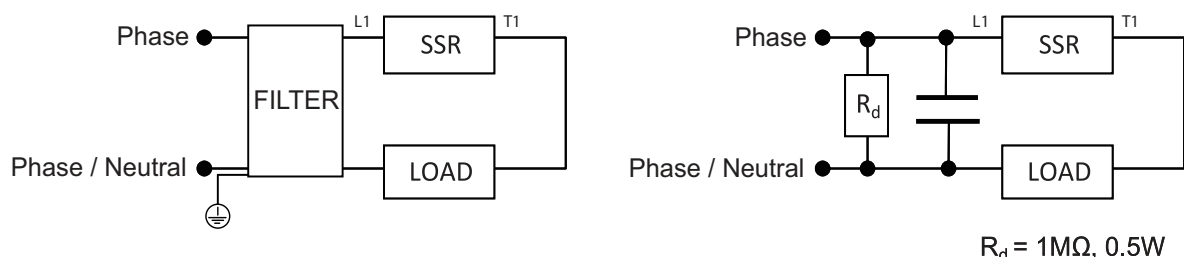

Environmental specifications

Operating temperature	-40°C to +70°C (-40°F to +158°F)
Storage temperature	-40°C to +100°C (-40°F to +212°F)
Relative humidity	95% non-condensing @ 40°C
Pollution degree	2
Installation altitude	0-1000m. Above 1000m derate linearly by 1% of FLC per 100 m up to a maximum of 2000m
Vibration resistance	2g / axis (2-100Hz, IEC 60068-2-6, EN 50155, EN 61373)
Impact resistance	15/11 g/ms (EN50155, EN61373)
EU RoHS compliant	Yes
China RoHS	

The declaration in this section is prepared in compliance with People's Republic of China Electronic Industry Standard SJ/T11364-2014: Marking for the Restricted Use of Hazardous Substances in Electronic and Electrical Products.

Part Name	Toxic or Harardous Substances and Elements					
	Lead (Pb)	Mercury (Hg)	Cadmium (Cd)	Hexavalent Chromium (Cr(VI))	Polybrominated biphenyls (PBB)	Polybrominated diphenyl ethers (PBDE)
Power Unit Assembly	x	o	o	o	o	o
O: Indicates that said hazardous substance contained in homogeneous materials for this part are below the limit requirement of GB/T 26572. X: Indicates that said hazardous substance contained in one of the homogeneous materials used for this part is above the limit requirement of GB/T 26572.						

这份申明根据中华人民共和国电子工业标准 SJ/T11364-2014：标注在电子电气产品中限定使用的有害物质

零件名称	有毒或有害物质与元素					
	铅 (Pb)	汞 (Hg)	镉 (Cd)	六价铬 (Cr(VI))	多溴化联苯 (PBB)	多溴联苯醚 (PBDE)
功率单元	x	o	o	o	o	o
O:此零件所有材料中含有的该有害物低于GB/T 26572的限定。 X: 此零件某种材料中含有的该有害物高于GB/T 26572的限定。						

Switching modes

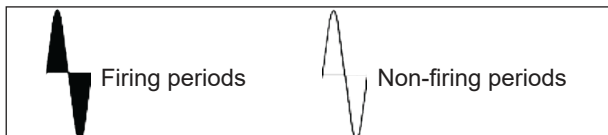

MODE 1: Phase angle switching

The Phase angle switching mode works in accordance with the phase angle control principle. The power delivered to the load is controlled by the firing of the thyristors over each half supply cycle. The firing angle varies in relation to the input signal level which determines the output power to be delivered to the load.

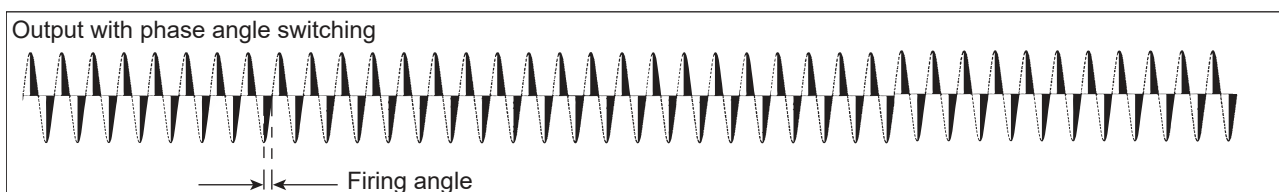

Full cycle switching:

In Full cycle switching modes only full cycles are being switched. Switching at zero voltage reduces EMC interference as compared to phase angle switching (mode 1). The ON full cycles are distributed over a specific time base. Compared to burst firing, this enables faster and more accurate control of the load in addition to extending the heater lifetime. This mode is suitable for use only with resistive loads.

MODE 2: 1x Full cycle switching

This mode offers the lowest resolution for full cycle switching, i.e., 1 full cycle. At 50% output power demand the SSR will switch ON the load for 1 full cycle and OFF for 1 full cycle in a repeated pattern. Below 50% output power demand, the non-firing period increases but the firing period remains fixed at 1 full cycle. Over 50% output power demand, the firing period increases but the non-firing period remains fixed at 1 full cycle.

Hence at 25% output power demand, the non-firing period gets longer and the SSR will switch ON the load for 1 full cycle and OFF for 3 full cycles in a repeated pattern. At 75% output power demand, the firing period is longer and the SSR will switch ON the load for 3 full cycles and OFF for 1 full cycle in a repeated pattern. At 100% output power demand, the SSR switches the load fully ON.

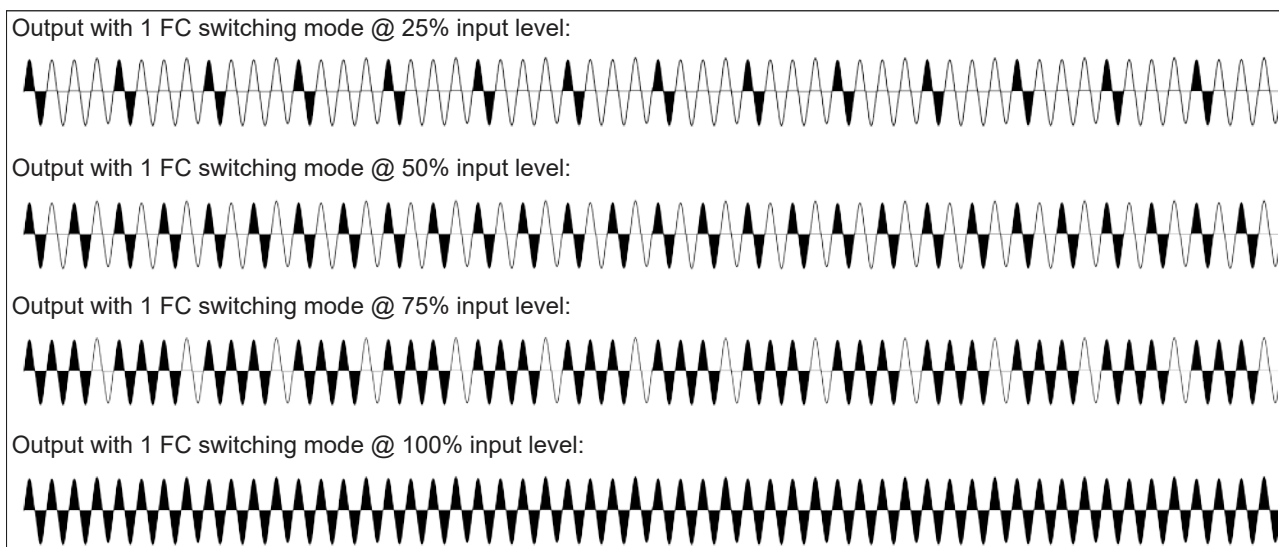

Switching modes

MODE 3: 4x Full cycle switching

MODE 4: 16x Full cycle switching

In mode 3 the minimum resolution is 4 full cycles. At 50% output power demand the SSR will switch ON the load for 4 full cycles and OFF for 4 full cycles in a repeated pattern. Below 50% output power demand, the non-firing period increases but the firing period remains fixed at 4 full cycles. Over 50% output power demand, the firing period increases but the non-firing period remains fixed at 4 full cycles.

In mode 4 the minimum resolution is 16 full cycles. At 50% output power demand the SSR will switch ON the load for 16 full cycles and OFF for 16 full cycles in a repeated pattern. Below 50% output power demand, the non-firing period increase but the firing period remains fixed at 16 full cycles. Over 50% output power demand the firing period increases but the non-firing period remains fixed at 16 full cycles.

Output with 4 FC switching mode @ 50% input level:



Output with 16 FC switching mode @ 50% input level:

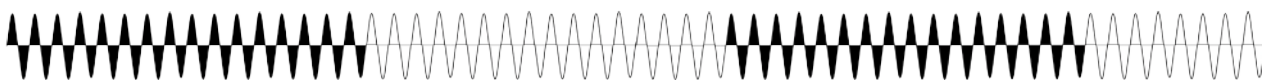

MODE 5: Advanced Full Cycle (AFC) switching

This switching mode is based on the principle of distributed full cycle explained above with the difference that the resolution for firing and nonfiring periods is changed to a half mains cycle. This mode is intended for use with short / medium wave infrared heaters. The purpose of the half cycle non-firing time is to reduce the annoying visual flickering of such lamp loads.

Below 50% output power demand, the SSR switches ON the load in half cycle periods. The non-firing periods are full cycles.

Above 50% output power demand, the SSR switches ON the load in full cycle periods but the non-firing periods are half cycles.

Output @ 33% input level:
Firing in half cycles, Non-firing in full cycles

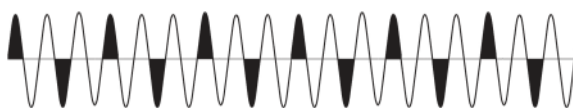

Output @ 66% input level:
Firing in full cycles, Non-firing in half cycles



SOFT STARTING

Soft starting is utilised to reduce the start-up current of loads having a high cold to hot resistance ratio such as short wave infrared heaters. The thyristor firing angle is gradually increased over a time period of maximum 5 seconds (settable through an accessible potentiometer) in order to apply the voltage (and current) to the load smoothly.

Soft starting is performed on the first power up and in cases of non firing periods exceeding 5 seconds. If soft start is stopped before soft start completion, it is assumed that a start was performed and the non firing period count start as soon as the soft start is stopped.

Switching modes

MODE 6: Soft start + MODE 4 (16x full cycle switching)

This switching mode works on the principle of switching mode 4 (16x full cycles) but soft starting is performed on power up or in case of the non firing periods exceeding 5 seconds. After the soft start is completed, full cycles (with a resolution of 16 full cycles) are delivered to the load according to the input signal, based on MODE 4 switching principle.

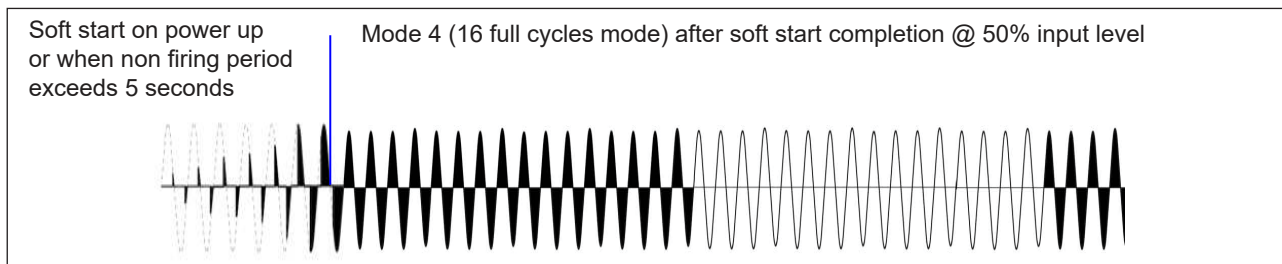

MODE 7: Soft start + MODE 5 (Advanced full cycle switching)

This switching mode works on the principle of the advanced full cycle (mode 5) but soft starting is performed on power up or in case of the non firing periods exceeding 5 seconds. After the soft start is completed, output power is delivered to the load according to the input signal, based on Mode 5 switching principle.

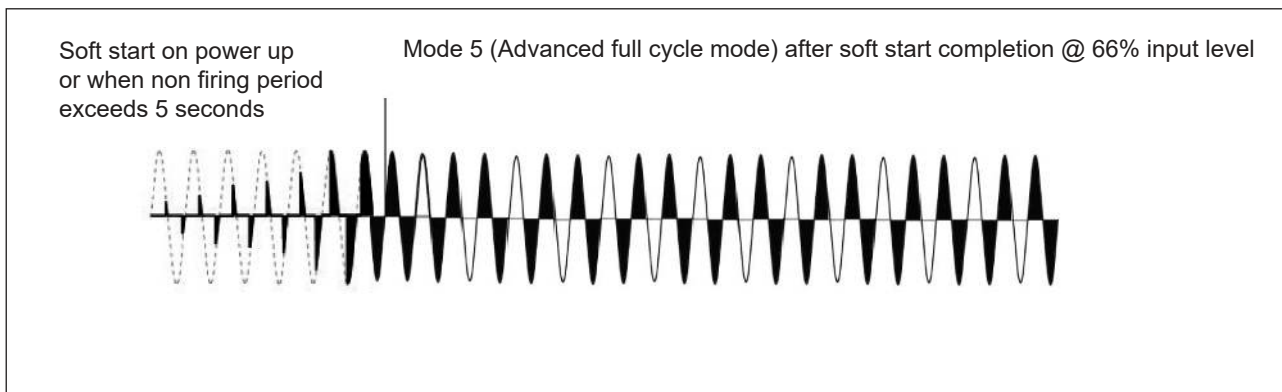

LED indicators

RGC1P..AA..

LED	Status	Timing Diagram
CONTROL (green)	Control input <4mA	[Pulse]
	Control input >4mA	[Pulse]
	Mains loss	[Pulse with 0.5s and 3s markers]
	SSR internal error	[Pulse with 0.5s and 3s markers]
LOAD (yellow)	LOAD ON	[Pulse]

RGC1P..V..

LED	Status	Timing Diagram
CONTROL (green)	Supply voltage (Us) ON	[Pulse]
	Control input >0V	[Pulse]
	Mains loss	[Pulse with 0.5s and 3s markers]
	SSR internal error	[Pulse with 0.5s and 3s markers]
LOAD (yellow)	LOAD ON	[Pulse]

Short circuit protection

Protection Co-ordination, Type 1 vs Type 2:

Type 1 protection implies that after a short circuit, the device under test will no longer be in a functioning state. In type 2 co-ordination the device under test will still be functional after the short circuit. In both cases, however, the short circuit has to be interrupted. The fuse between enclosure and supply shall not open. The door or cover of the enclosure shall not be blown open. There shall be no damage to conductors or terminals and the conductors shall not separate from terminals. There shall be no breakage or cracking of insulating bases to the extent that the integrity of the mounting of live parts is impaired. Discharge of parts or any risk of fire shall not occur.

The product variants listed in the table hereunder are suitable for use on a circuit capable of delivering not more than 100,000 A Symmetrical Amperes, 600 Volts maximum when protected by fuses. Tests at 100,000 Arms were performed with Class J fuses, fast acting; please refer to the tables below for maximum ratings. Tests with Class J fuses are representative of Class CC fuses.

Protection co-ordination Type 1 according to UL 508				
Part No.	Prospective short circuit current [kArms]	Max fuse size [A]	Class	Voltage [VCA]
RGC1P..12	100	30	J or CC	Max. 600
RGC1P..30		30	J or CC	
RGC1P..42		80	J	
RGC1P..50		30	J	
RGC1P..62		80	J	

Protection co-ordination Type 2 (IEC/EN 60947-4-3)						
Part No.	Prospective short circuit current [kArms]	Ferraz Shawmut (Mersen)		Siba		Max. voltage [VCA]
		Max fuse size [A]	Part number	Max fuse size [A]	Part number	
RGC1P..12 RGC1P..30	10 100	40	6.9xx CP GRC 22x58 /40	32	50 142 06.32	600
RGC1P..42	10					
		70	A70QS70-4			
	100	63	6.9xx CP URC 14x51 /63			
		70	A70QS70-4			
RGC1P..50	10	80	6.621 CP URQ 27x60 /80	80	50 142 20.80	
	100	n/a	n/a			
RGC1P..62	10	100	6.9xx CP GRC 22x58 /100	100	50 142 20.100	
			A70QS100-4			
	6.621 CP URGD 27x60 /100					
	A70QS100-4					
	100					

xx = 00, without fuse trip indication,
xx = 21, with fuse trip indication

Protection co-ordination Type 2 with Minature Circuit Breakers (M.C.B.s)					
Solid State Relay type	ABB Model no. for Z - type M.C.B. (rated current)	ABB Model no. for B - type M.C.B. (rated current)	Wire cross sectional area [mm ²]	Minimum length of Cu wire conductor [m] ⁸	
RGC1P..12 RGC1P..30 (1800 A²s)	S201 - Z10 (10A)	S201-B4 (4A)	1.0	7.6	
			1.5	11.4	
			2.5	19.0	
	S201 - Z16 (16A)	S201-B6 (6A)	1.0	5.2	
			1.5	7.8	
			2.5	13.0	
			4.0	20.8	
	S201 - Z20 (20A)	S201-B10 (10A)	1.5	12.6	
			2.5	21.0	
	S201 - Z25 (25A)	S201-B13 (13A)	2.5	25.0	
			4.0	40.0	
	S202 - Z25 (25A)	S202-B13 (13A)	2.5	19.0	
			4.0	30.4	
	RGC1P..50 (3200 A²s)	S201-Z25 (25A)	S201-B16 (13A)	2.5	7.0
				4.0	11.2
6.0				16.8	
RGC1P..42 RGC1P..62 (18000 A²s)	S201 - Z32 (32A)	S201-B16 (16A)	2.5	3.0	
			4.0	4.8	
			6.0	7.2	
	S201 - Z50 (50A)	S201-B25 (25A)	4.0	4.8	
			6.0	7.2	
			10.0	12.0	
			16.0	19.2	
	S201 - Z63 (63A)	S201-B32 (32A)	6.0	7.2	
			10.0	12.0	
16.0			19.2		

8. Between M.C.B. and Load (including return path which goes back to the mains)

Note:

A prospective current of 6 kA and a 230 / 400 V power supply is assumed for the above suggested specifications. For cables with different cross-sectional area than those mentioned above, please consult Carlo Gavazzi's Technical Support Group.

S201 models refer to 1-pole M.C.B., S202 models refer to 2-poles M.C.B.

► Dimensions

RGC1P.12

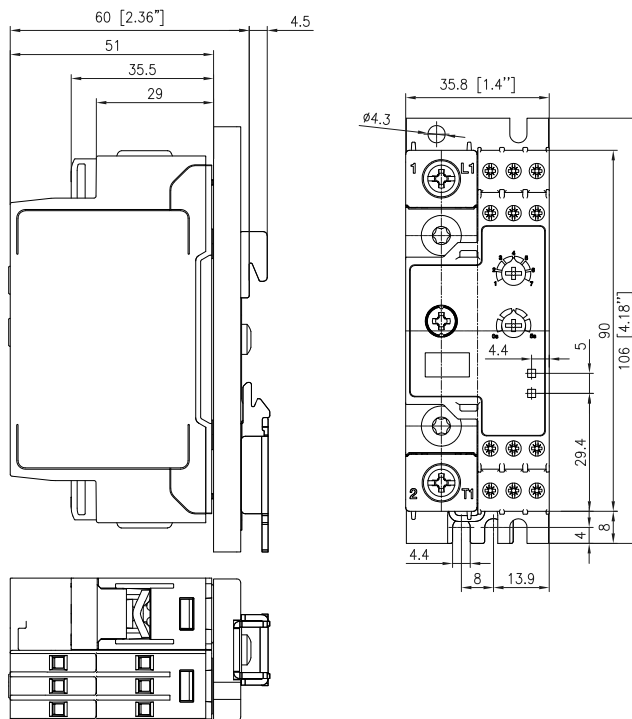

RGC1P.30

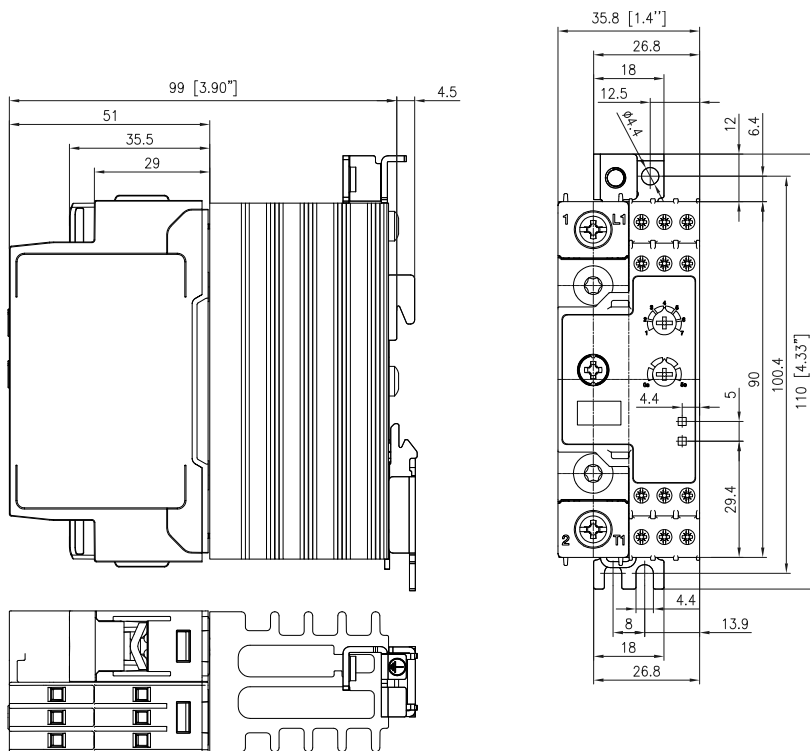

Housing width tolerance +0.5 mm, -0 mm as per DIN 43880. All other tolerances +/- 0.5 mm. Dimensions in mm.

Note: The indicated depth dimension of the RGx1P has to be increased by 3 mm when the tamper proof cover accessory is mounted on the device.

► Dimensions (continued)

RGC1P..42

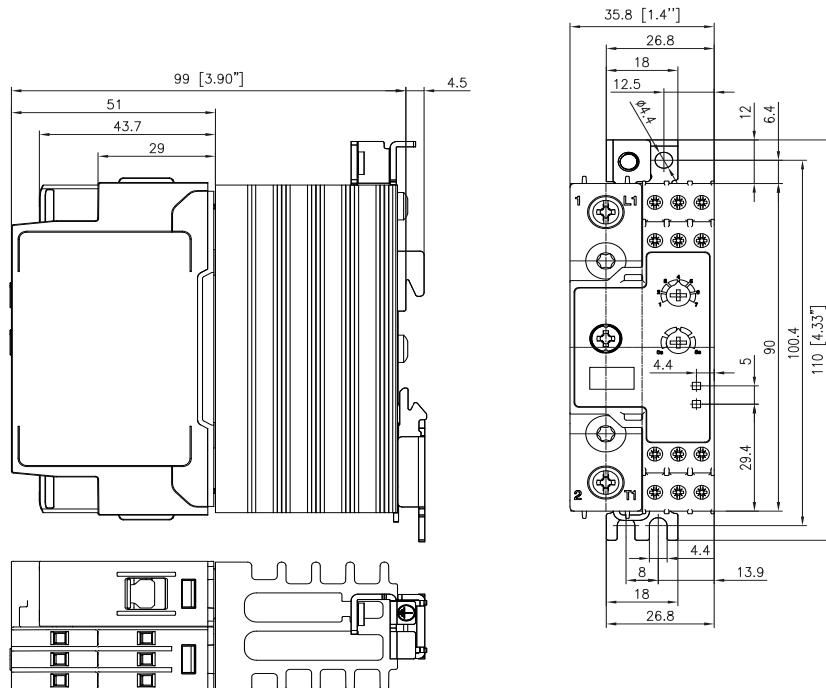

RGC1P..50, RGC1P..62

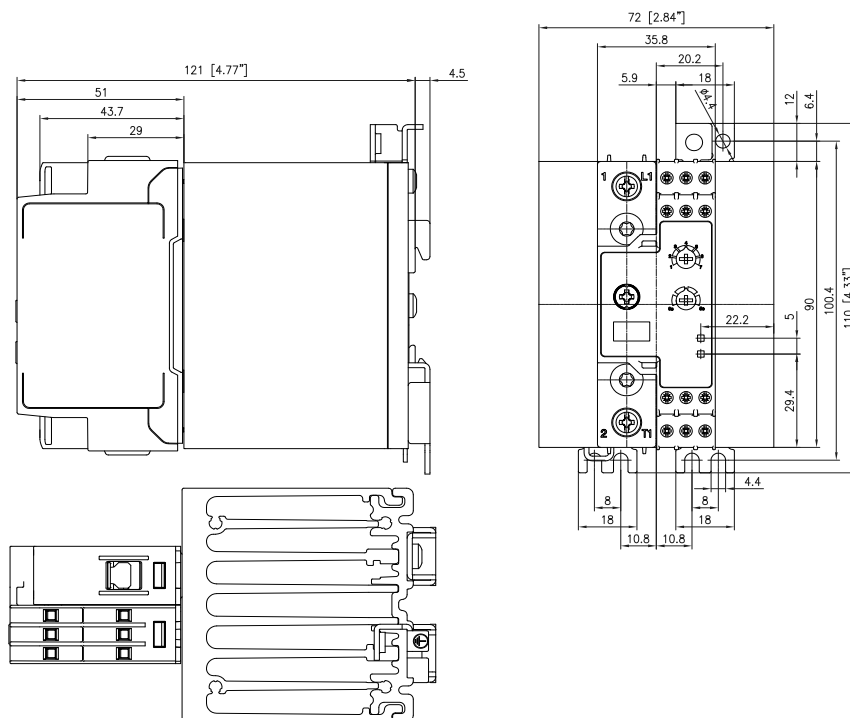

Housing width tolerance +0.5 mm, -0 mm as per DIN 43880. All other tolerances +/- 0.5 mm. Dimensions in mm.

Note: The indicated depth dimension of the RGx1P has to be increased by 3 mm when the tamper proof cover accessory is mounted on the device.

Terminal interface

RGC1P..AA..

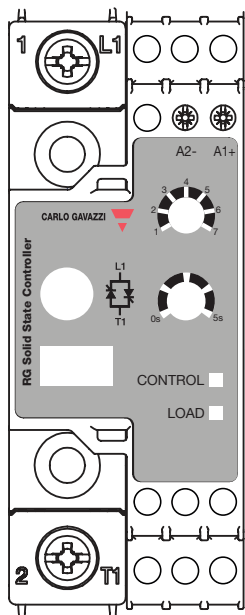

Terminals labelling:

- 1/L1: Line connection
- 2/T1: Load connection
- A1 - A2: Control input: 4 - 20 mA

RGC1P..V..

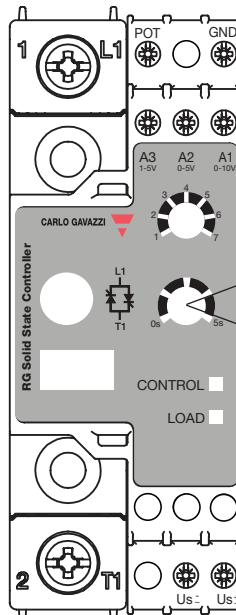

Terminals labelling:

- 1/L1: Line connection
- 2/T1: Load connection
- A1-GND: Control input: 0-10 V
- A2-GND: Control input: 0-5 V
- A3-GND: Control input: 1-5 V
- POT: External potentiometer input
- Us (+, ~): External supply, positive signal (RG..V..D) or AC signal (RG..V..A)
- Us (-, ~): External supply, ground (RG..V..D) or AC signal (RG..V..A)

Ramp up time setting for soft starting, applicable for Modes 6 and 7 only

Mode Selection	Switching mode	
	1	Phase angle (default setting)
	2	1x full cycle
	3	4x full cycles
	4	16x full cycles
	5	Advanced full cycle
	6	Soft start + 16x full cycles
	7	Soft start + advanced full cycle

Connection diagram

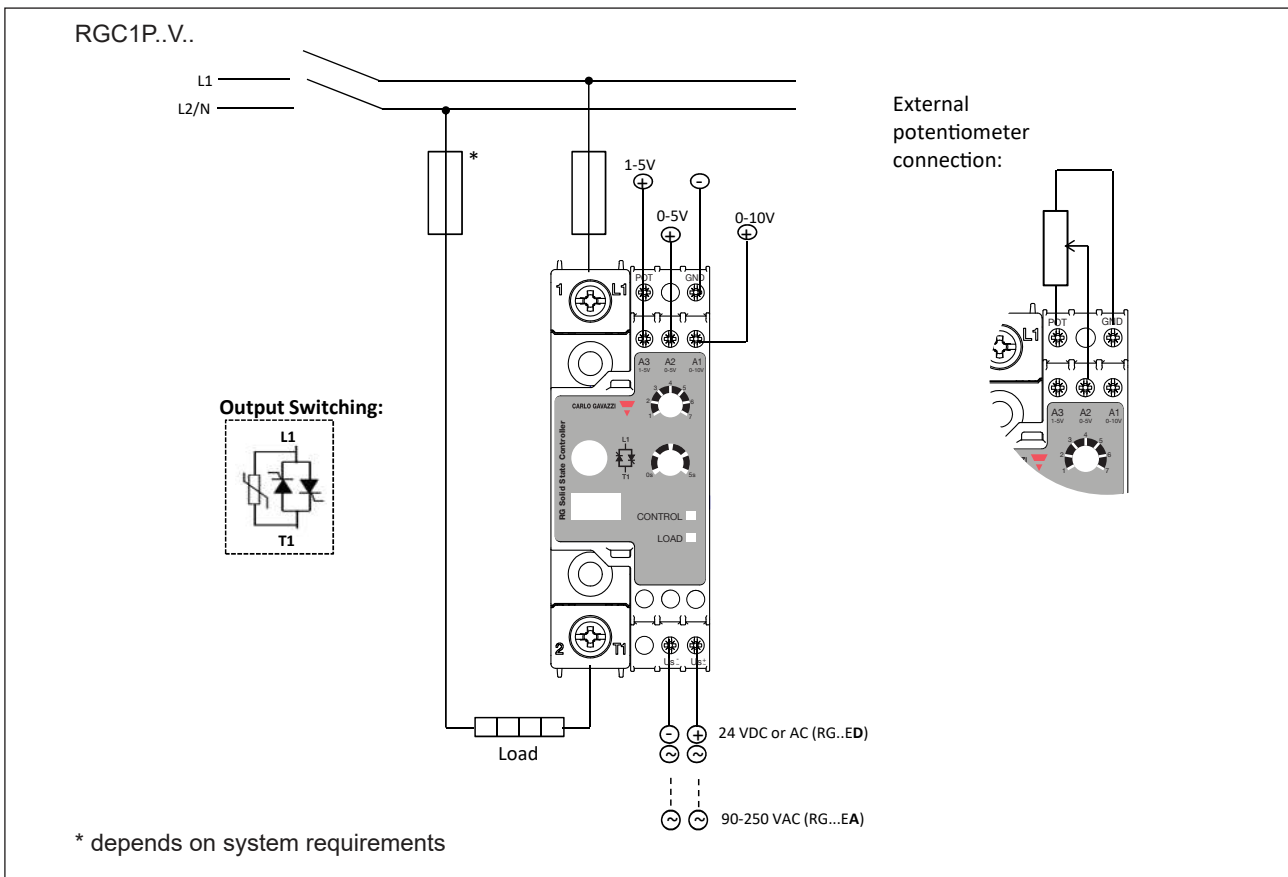
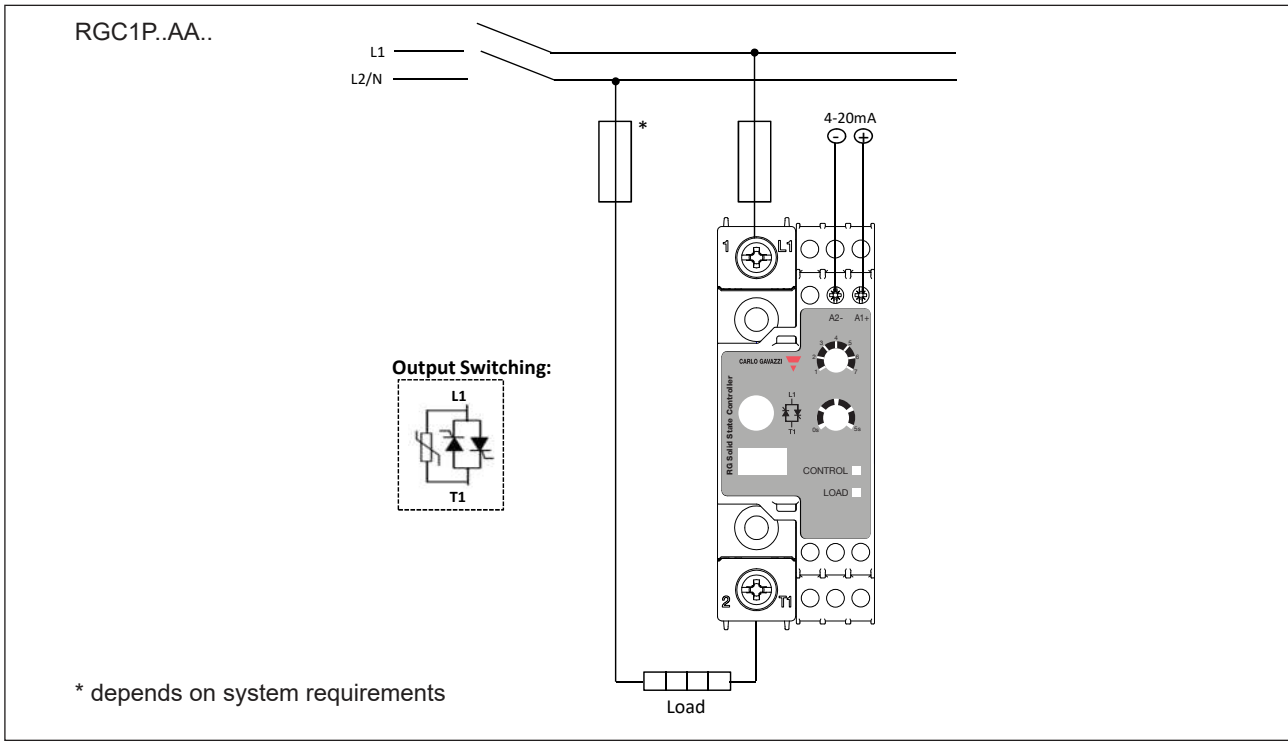

▶ **Mounting instructions**

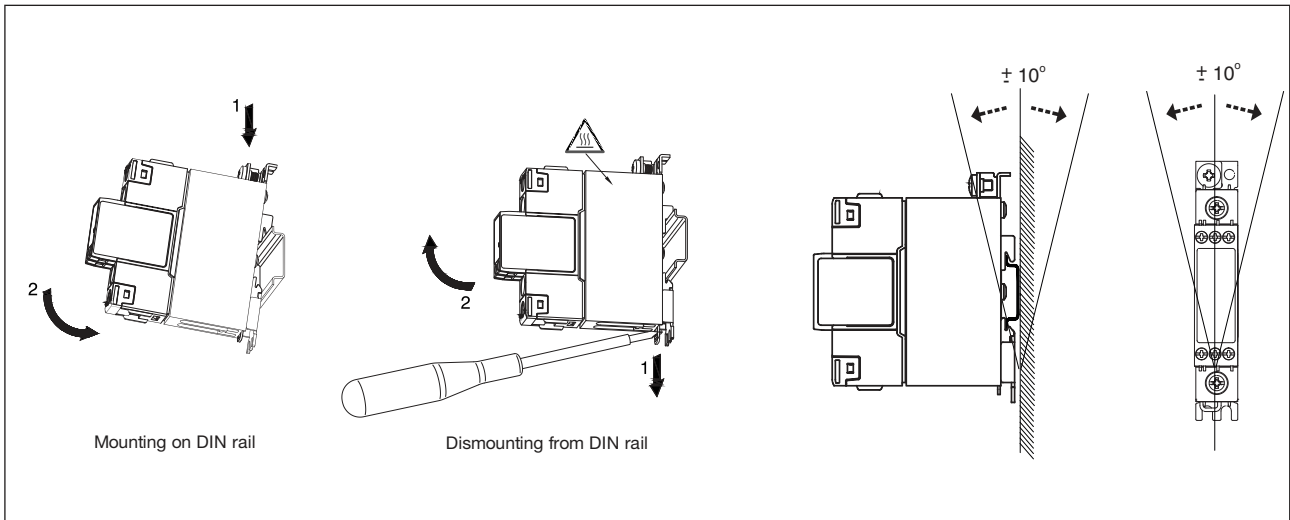

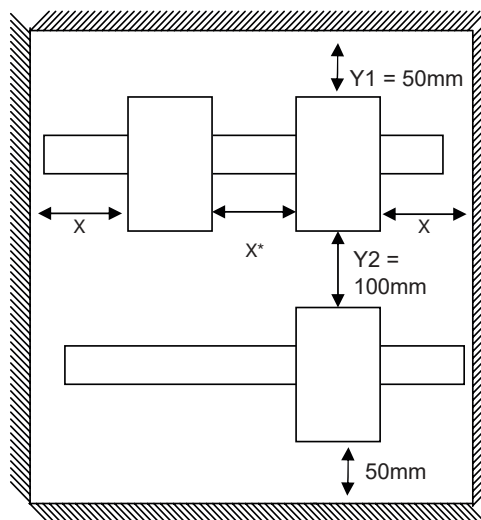

▶ **Installation instructions**



* Refer to Current derating vs spacing curves. Spacing between SSR and panel walls should be > 5 mm.

Connection Specifications

Power connections			
Terminals	1/L1, 2/T1		
Conductors	Use 75°C copper (Cu) conductors		
	RGC1P..12, RGC1P..30	RGC1P..42, RGC1P..50, RGC1P..62	
			
Connection type	M4 screw with captivated washer		M5 screw with box clamp
Stripping length	12 mm		11 mm
Rigid (solid & stranded) UL/cUL rated data	2x 2.5 – 6.0 mm ² 2x 14 – 10 AWG	1x 2.5 – 6.0 mm ² 1x 14 – 10 AWG	1x 2.5 – 25.0 mm ² 1x 14 – 3 AWG
Flexible with end sleeve	2x 1.0 – 2.5 mm ² 2x 2.5 – 4.0 mm ² 2x 18 – 14 AWG 2x 14 – 12 AWG	1x 1.0 – 4.0 mm ² 1x 18 – 12 AWG	1x 2.5 – 16.0 mm ² 1x 14 – 6 AWG
Flexible without end sleeve	2x 1.0 – 2.5 mm ² 2x 2.5 – 6.0 mm ² 2x 18 – 14 AWG 2x 14 – 10 AWG	1x 1.0 – 6.0 mm ² 1x 18 – 10 AWG	1x 4.0 – 25.0 mm ² 1x 12 – 3 AWG
Torque specifications	Pozidriv 2 UL: 2.0 Nm (17.7 lb-in) IEC: 1.5 – 2.0 Nm (13.3 – 17.7 lb-in)		Pozidriv 2 UL: 2.5 Nm (22 lb-in) IEC: 2.5 – 3.0 Nm (22 – 26.6 lb-in)
Aperture for termination lug (fork or ring)	12.3 mm		n/a
Protective Earth (PE) connection	M5, 1.5 Nm (13.3 lb-in) M5 PE screw is not provided with the solid state relay. PE connection is required when product is intended to be used in Class 1 applications according to EN/IEC 61140		

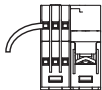
Control connections	
Terminals	GND, A1, A2, A3, POT, Us
Conductors	Use 60/75°C copper (Cu) conductors
	
Connection type	M3 screw with box clamp
Stripping length	8 mm
Rigid (solid & stranded) UL/cUL rated data	1x 1.0 - 2.5 mm ² 1x 18 - 12 AWG
Flexible with end sleeve	1x 0.5 - 2.5 mm ² 1x 20 - 12 AWG
Torque specification	Pozidriv 1 UL 0.5 Nm (4.4 lb-in), IEC: 0.4-0.5 Nm (3.5-4.4 lb-in)



COPYRIGHT ©2023
Content subject to change.
Download the PDF: <https://gavazziautomation.com>