

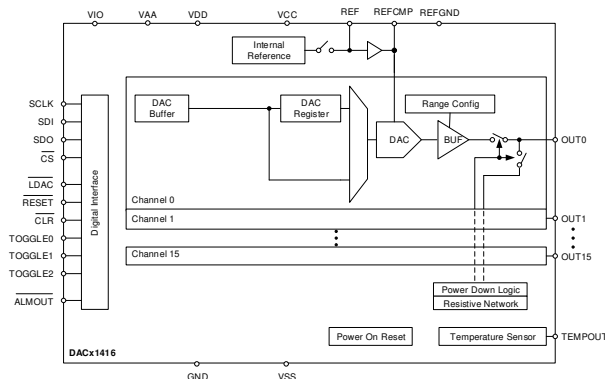
# DACx1416 16-Channel, 16-Bit, 14-Bit, and 12-Bit High-Voltage Output DACs With Internal Reference

## 1 Features

- Performance
  - Specified monotonic at 16-bit resolution
  - INL:  $\pm 1$  LSB maximum at 16-bit resolution
  - TUE:  $\pm 0.1\%$  of FSR maximum
- Integrated 2.5-V precision internal reference
  - Initial accuracy:  $\pm 2.5$  mV maximum
  - Low drift: 5 ppm/ $^{\circ}\text{C}$  typical
- Flexible output configuration
  - Output range:  $\pm 2.5$  V,  $\pm 5$  V,  $\pm 10$  V,  $\pm 20$  V, 0 to 5 V, 0 to 10 V, 0 to 20 V or 0 to 40 V
  - Differential output mode
- High drive capability:  $\pm 25$  mA with 1.5 V from supply rails
- Three dedicated A-B toggle pins for dither signal generation
- Analog temperature output
  - Sensor gain of  $-4$  mV/ $^{\circ}\text{C}$
- 50-MHz SPI-compatible serial interface
  - 4-wire mode, 1.7-V to 5.5-V operation
  - Daisy-chain operation
  - CRC error check
- Temperature range:  $-40^{\circ}\text{C}$  to  $+125^{\circ}\text{C}$
- Small package
  - 6 mm  $\times$  6 mm, 40-pin VQFN

## 2 Applications

- [Inter-DC interconnect \(long-haul, submarine\)](#)
- [Inter-DC interconnect \(metro\)](#)
- [Optical module](#)
- [Semiconductor test](#)
- [Lab and field instrumentation](#)
- [Data acquisition \(DAQ\)](#)



**Functional Block Diagram**

## 3 Description

The DAC81416, DAC71416, and DAC61416 (DACx1416) are a pin-compatible family of 16-channel, buffered, high-voltage output digital-to-analog converters (DACs) with 16-bit, 14-bit, and 12-bit resolution. The DACx1416 include a low-drift, 2.5-V internal reference, eliminating the need for an external precision reference in most applications. These devices are specified monotonic and provide high linearity of  $\pm 1$  LSB INL.

A user-selectable output configuration enables full-scale bipolar output voltages of  $\pm 20$  V,  $\pm 10$  V,  $\pm 5$  V or  $\pm 2.5$  V, and full-scale unipolar output voltages of 40 V, 20 V, 10 V or 5 V. The full-scale output range for each DAC channel is independently programmable. The integrated DAC output buffers can sink or source up to 25 mA, thus limiting the need for additional operational amplifiers. Each pair of channels can be configured to provide a differential output with offset calibration. The three dedicated A-B toggle pins enable dither signal generation with up to three possible frequencies.

The DACx1416 incorporate a power-on-reset circuit that connects the DAC outputs to ground at power up. The outputs remain in this state until the device registers are properly configured for operation.

Communication with the DACx1416 is performed through a 4-wire serial interface that supports operation from 1.7 V to 5.5 V.

### Device Information

PART NUMBER	PACKAGE <sup>(1)</sup>	BODY SIZE (NOM)
DAC81416	VQFN (40)	6.00 mm $\times$ 6.00 mm
DAC71416		
DAC61416		

- (1) For all available packages, see the orderable addendum at the end of the data sheet.



## Table of Contents

<b>1 Features</b> .....	1	8.5 Programming.....	27
<b>2 Applications</b> .....	1	8.6 Register Maps.....	30
<b>3 Description</b> .....	1	<b>9 Application and Implementation</b> .....	45
<b>4 Revision History</b> .....	2	9.1 Application Information.....	45
<b>5 Device Comparison Table</b> .....	3	9.2 Typical Application.....	45
<b>6 Pin Configuration and Functions</b> .....	3	<b>10 Power Supply Recommendations</b> .....	49
<b>7 Specifications</b> .....	5	<b>11 Layout</b> .....	50
7.1 Absolute Maximum Ratings .....	5	11.1 Layout Guidelines.....	50
7.2 ESD Ratings .....	5	11.2 Layout Example.....	50
7.3 Recommended Operating Conditions .....	5	<b>12 Device and Documentation Support</b> .....	51
7.4 Thermal Information .....	6	12.1 Device Support.....	51
7.5 Electrical Characteristics .....	6	12.2 Documentation Support.....	51
7.6 Timing Requirements .....	10	12.3 Receiving Notification of Documentation Updates..	51
7.7 Timing Diagrams.....	12	12.4 Support Resources.....	51
7.8 Typical Characteristics.....	13	12.5 Trademarks.....	51
<b>8 Detailed Description</b> .....	21	12.6 Electrostatic Discharge Caution.....	51
8.1 Overview.....	21	12.7 Glossary.....	51
8.2 Functional Block Diagram.....	21	<b>13 Mechanical, Packaging, and Orderable</b>	
8.3 Feature Description.....	22	<b>Information</b> .....	51
8.4 Device Functional Modes.....	25		

## 4 Revision History

NOTE: Page numbers for previous revisions may differ from page numbers in the current version.

<b>Changes from Revision A (November 2018) to Revision B (June 2021)</b>	<b>Page</b>
• Updated the numbering format for tables, figures, and cross-references throughout the document.....	1
• Changed formatting and minor editorial issues for clarity.....	1

---

<b>Changes from Revision * (July 2018) to Revision A (November 2018)</b>	<b>Page</b>
• Changed DAC81416 from Advance Information to Production Data .....	1
• Changed DAC71416 and DAC61416 from Product Preview to Production Data .....	1

## 5 Device Comparison Table

DEVICE	RESOLUTION
DAC81416	16-bit
DAC71416	14-bit
DAC61416	12-bit

## 6 Pin Configuration and Functions

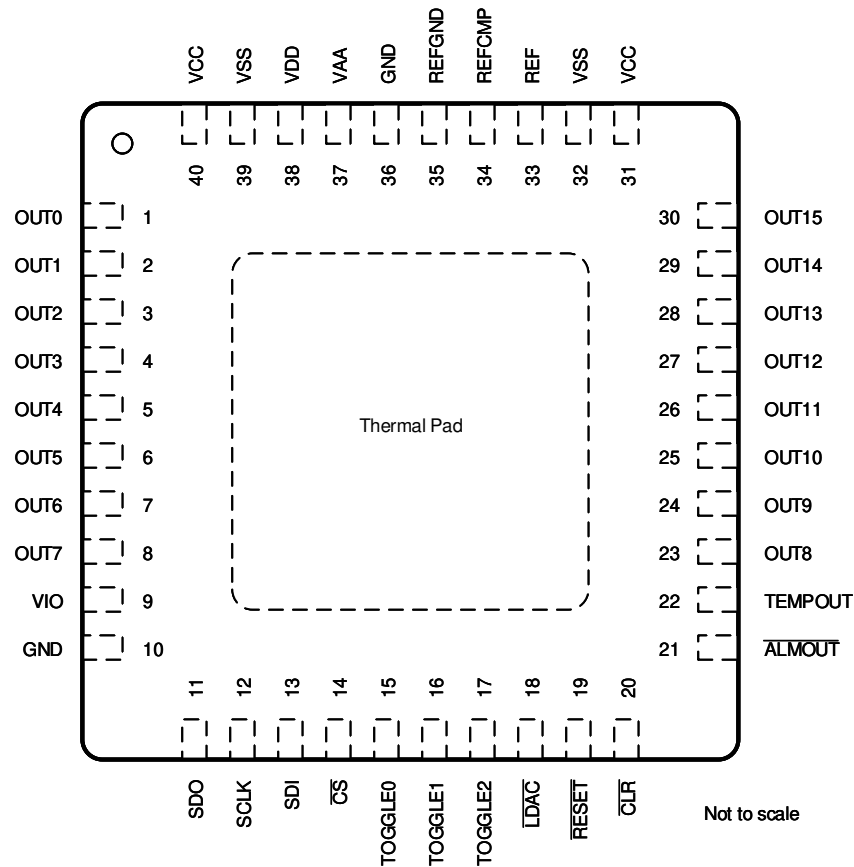


Figure 6-1. RHA Package, 40-Pin VQFN, Top View

Table 6-1. Pin Functions

PIN		TYPE	DESCRIPTION
NO.	NAME		
1	OUT0	Output	Channel 0 analog DAC output voltage.
2	OUT1	Output	Channel 1 analog DAC output voltage.
3	OUT2	Output	Channel 2 analog DAC output voltage.
4	OUT3	Output	Channel 3 analog DAC output voltage.
5	OUT4	Output	Channel 4 analog DAC output voltage.
6	OUT5	Output	Channel 5 analog DAC output voltage.
7	OUT6	Output	Channel 6 analog DAC output voltage.
8	OUT7	Output	Channel 7 analog DAC output voltage.
9	VIO	Power	IO supply voltage. (1.7 V to 5.5 V). This pin sets the I/O operating voltage for the device.
10, 36	GND	Ground	Ground reference point for all circuitry on the device.
11	SDO	Output	Serial interface data output. The SDO pin must be enabled before operation by setting the SDO-EN bit. Data are clocked out of the input shift register on either rising or falling edges of the SCLK pin as specified by the FSDO bit (rising edge by default).

**Table 6-1. Pin Functions (continued)**

PIN		TYPE	DESCRIPTION
NO.	NAME		
12	SCLK	Input	Serial interface clock.
13	SDI	Input	Serial interface data input. Data are clocked into the input shift register on each falling edge of the SCLK pin.
14	$\overline{CS}$	Input	Active low serial data enable. This input is the frame synchronization signal for the serial data. When the signal goes low, it enables the serial interface input shift register.
15	TOGGLE0	Input	Toggle pin 0. Control signal for those DAC outputs configured for toggle operation to switch between the two DAC data registers associated with each DAC. A logic low updates the DAC output to the value set by Register A. A logic high updates the DAC output to the value set by Register B. Connect the TOGGLE0 pin to ground if unused.
16	TOGGLE1	Input	Toggle pin 1. Control signal for those DAC outputs configured for toggle operation to switch between the two DAC data registers associated with each DAC. A logic low updates the DAC output to the value set by Register A. A logic high updates the DAC output to the value set by Register B. Connect the TOGGLE1 pin to ground if unused.
17	TOGGLE2	Input	Toggle pin 2. Control signal for those DAC outputs configured for toggle operation to switch between the two DAC data registers associated with each DAC. A logic low updates the DAC output to the value set by Register A. A logic high updates the DAC output to the value set by Register B. Connect the TOGGLE2 pin to ground if unused.
18	$\overline{LDAC}$	Input	Active low synchronization signal. When the $\overline{LDAC}$ pin is low, the DAC outputs of those channels configured in synchronous mode are updated simultaneously. Connect to VIO if unused.
19	$\overline{RESET}$	Input	Active low reset input. Logic low on this pin causes the device to issue a power-on-reset event.
20	$\overline{CLR}$	Input	Active low clear input. Logic low on this pin clears all DAC outputs to their clear code. Connect to VIO if unused.
21	ALMOUT	Output	ALMOUT is an open drain alarm output. An external 10-k $\Omega$ pull-up resistor to a voltage no higher than VIO is required.
22	TEMPOUT	Output	Analog temperature monitor output.
23	OUT8	Output	Channel 8 analog DAC output voltage.
24	OUT9	Output	Channel 9 analog DAC output voltage.
25	OUT10	Output	Channel 10 analog DAC output voltage.
26	OUT11	Output	Channel 11 analog DAC output voltage.
27	OUT12	Output	Channel 12 analog DAC output voltage.
28	OUT13	Output	Channel 13 analog DAC output voltage.
29	OUT14	Output	Channel 14 analog DAC output voltage.
30	OUT15	Output	Channel 15 analog DAC output voltage.
31, 40	VCC	Power	Output positive analog power supply (9 V to 41.5 V).
32, 39	VSS	Power	Output negative analog power supply (–21.5 V to 0 V).
33	REF	Input/Output	Reference input to the device when operating with external reference. When using internal reference, this is the reference output voltage pin. Connect a 150-nF capacitor to ground.
34	REFCMP	Input/Output	Reference compensation capacitor connection. Connect a 330-pF capacitor between REFCMP and REFGND.
35	REFGND	Ground	Ground reference point for the internal reference.
37	VAA	Power	Analog supply voltage (4.5 V to 5.5 V). This pin must be at the same potential as the VDD pin.
38	VDD	Power	Digital supply voltage (4.5 V to 5.5 V). This pin must be at the same potential as the VAA pin.
Thermal Pad	Thermal Pad	—	The thermal pad is located on the package underside. Connect the thermal pad to any internal PCB ground plane through multiple vias for good thermal performance.

## 7 Specifications

### 7.1 Absolute Maximum Ratings

over operating free-air temperature range (unless otherwise noted)<sup>(1)</sup>

		MIN	MAX	UNIT
Supply voltage	V <sub>DD</sub> to GND	-0.3	6	V
	V <sub>IO</sub> to GND	-0.3	6	V
	V <sub>CC</sub> to GND	-0.3	44	V
	V <sub>SS</sub> to GND	-22	0.3	V
	REFGND to GND	-0.3	0.9	V
	V <sub>DD</sub> to V <sub>AA</sub>	-0.3	0.3	V
	V <sub>CC</sub> to V <sub>SS</sub>	-0.3	44	V
Pin voltage	DAC outputs to GND	V <sub>SS</sub> - 0.3	V <sub>CC</sub> + 0.3	V
	TEMPOUT to GND	-0.3	V <sub>DD</sub> + 0.3	V
	REF and REFCMP to GND	-0.3	V <sub>DD</sub> + 0.3	V
	Digital inputs to GND	-0.3	V <sub>IO</sub> + 0.3	V
	SDO to GND	-0.3	V <sub>IO</sub> + 0.3	V
	ALARMOUT to GND	-0.3	6	V
T <sub>J</sub>	Operating junction temperature	-40	150	°C
T <sub>stg</sub>	Storage temperature	-60	150	°C

- (1) Stresses beyond those listed under Absolute Maximum Ratings may cause permanent damage to the device. These are stress ratings only, which do not imply functional operation of the device at these or any other conditions beyond those indicated under Recommended Operating Conditions. Exposure to absolute-maximum-rated conditions for extended periods may affect device reliability.

### 7.2 ESD Ratings

			VALUE	UNIT
V <sub>(ESD)</sub>	Electrostatic discharge	Human body model (HBM), per ANSI/ESDA/JEDEC JS-001 <sup>(1)</sup>	±1000	V
		Charged device model (CDM), per JEDEC specification JESD22-C101 <sup>(2)</sup>	±500	

- (1) JEDEC document JEP155 states that 500-V HBM allows safe manufacturing with a standard ESD control process.  
(2) JEDEC document JEP157 states that 250-V CDM allows safe manufacturing with a standard ESD control process.

### 7.3 Recommended Operating Conditions

over operating free-air temperature range (unless otherwise noted)

		MIN	NOM	MAX	UNIT
V <sub>AA</sub> <sup>(1)</sup>	Analog supply voltage	4.5		5.5	V
V <sub>DD</sub> <sup>(1)</sup>	Digital supply voltage	4.5		5.5	V
V <sub>IO</sub>	IO supply voltage	1.7		5.5	V
V <sub>CC</sub>	Output buffer positive supply voltage	9		41.5	V
V <sub>SS</sub> <sup>(2)</sup>	Output buffer negative supply voltage	-21.5		0	V
V <sub>CC</sub> - V <sub>SS</sub>	Output buffer supply voltage range	9		43	V
	Digital input voltage	0		V <sub>IO</sub>	V
V <sub>REFIN</sub>	Reference input voltage to V <sub>REFGND</sub>	2.49	2.5	2.51	V
V <sub>REFGND</sub> <sup>(3)</sup>	REFGND pin voltage	0	0	0.6	V
T <sub>A</sub>	Operating ambient temperature	-40		125	°C

- (1) V<sub>AA</sub> and V<sub>DD</sub> must be at the same potential.  
(2) V<sub>SS</sub> is only connected to GND when all DAC outputs are unipolar.  
(3) If V<sub>REFGND</sub> is not connected to GND, a buffered source must be used to drive it.

## 7.4 Thermal Information

THERMAL METRIC <sup>(1)</sup>		DACx1416	UNIT
		RHA (VQFN)	
		40 PINS	
R <sub>ΘJA</sub>	Junction-to-ambient thermal resistance	26.8	°C/W
R <sub>ΘJC(top)</sub>	Junction-to-case (top) thermal resistance	14.1	°C/W
R <sub>ΘJB</sub>	Junction-to-board thermal resistance	3.4	°C/W
Ψ <sub>JT</sub>	Junction-to-top characterization parameter	0.2	°C/W
Ψ <sub>JB</sub>	Junction-to-board characterization parameter	3.4	°C/W
R <sub>ΘJC(bot)</sub>	Junction-to-case (bottom) thermal resistance	0.7	°C/W

(1) For more information about traditional and new thermal metrics, see the [Semiconductor and IC Package Thermal Metrics](#) application report.

## 7.5 Electrical Characteristics

all minimum/maximum specifications at T<sub>A</sub> = –40°C to +125°C and all typical specifications at T<sub>A</sub> = 25°C, V<sub>CC</sub> = 9 V to 41.5 V, V<sub>SS</sub> = –21.5 V to 0 V, V<sub>DD</sub> = V<sub>AA</sub> = 4.5 V to 5.5 V, V<sub>REFIN</sub> = 2.5 V, V<sub>IO</sub> = 1.7 V to 5.5 V, DAC outputs unloaded, digital inputs at V<sub>IO</sub> or GND (unless otherwise noted)

PARAMETER	TEST CONDITIONS	MIN	TYP	MAX	UNIT
<b>STATIC PERFORMANCE<sup>(1)</sup></b>					
Resolution	DAC81416	16			Bits
	DAC71416	14			
	DAC61416	12			
INL	DAC81416, all ranges, except 0 V to 40 V and ±2.5 V	–1	±0.5	1	LSB
	DAC81416, 0 V to 40 V and ±2.5-V ranges	–2	±1	2	
	DAC71416, all ranges	–1	±0.5	1	
	DAC61416, all ranges	–1	±0.5	1	
DNL	DAC81416, specified 16-bit monotonic	–1	±0.5	1	LSB
	DAC71416, specified 14-bit monotonic	–1	±0.5	1	
	DAC61416, specified 12-bit monotonic	–1	±0.5	1	
TUE	All ranges, except ±2.5 V	–0.1	±0.01	0.1	%FSR
	±2.5-V range	–0.2	±0.02	0.2	
	Unipolar offset error	–0.03	±0.015	0.03	%FSR
	Unipolar zero-code error	0	0.04	0.1	%FSR
	Bipolar zero error	–0.2	±0.02	0.2	%FSR
	Full-scale error	–0.2	±0.075	0.2	%FSR
Gain error	All ranges, except ±2.5 V	–0.1	±0.02	0.1	%FSR
	±2.5-V range	–0.2	±0.02	0.2	
	Unipolar offset error drift		±2		ppm of FSR/°C
	Bipolar zero error drift		±2		ppm of FSR/°C
	Gain error drift		±2		ppm of FSR/°C
	Output voltage drift over time	T <sub>A</sub> = 40°C, full-scale code, 1900 hours		5	ppm of FSR

## 7.5 Electrical Characteristics (continued)

all minimum/maximum specifications at  $T_A = -40^\circ\text{C}$  to  $+125^\circ\text{C}$  and all typical specifications at  $T_A = 25^\circ\text{C}$ ,  $V_{CC} = 9\text{ V}$  to  $41.5\text{ V}$ ,  $V_{SS} = -21.5\text{ V}$  to  $0\text{ V}$ ,  $V_{DD} = V_{AA} = 4.5\text{ V}$  to  $5.5\text{ V}$ ,  $V_{REFIN} = 2.5\text{ V}$ ,  $V_{IO} = 1.7\text{ V}$  to  $5.5\text{ V}$ , DAC outputs unloaded, digital inputs at  $V_{IO}$  or GND (unless otherwise noted)

PARAMETER		TEST CONDITIONS	MIN	TYP	MAX	UNIT
<b>DIFFERENTIAL MODE PERFORMANCE<sup>(1)</sup></b>						
TUE	Total unadjusted error	All ranges	-0.1	±0.01	0.1	%FSR
		±2.5-V range	-0.2	±0.02	0.2	
	Common-mode error	All bipolar ranges, midscale code	-0.1	±0.01	0.1	%FSR
<b>OUTPUT CHARACTERISTICS</b>						
	Output voltage headroom	To $V_{SS}$ and $V_{CC}$ ( $-10\text{ mA} \leq I_{OUT} \leq 10\text{ mA}$ )	1			V
		To $V_{SS}$ and $V_{CC}$ ( $-15\text{ mA} \leq I_{OUT} \leq 15\text{ mA}$ )	1.5			
	Short-circuit current <sup>(2)</sup>	Full-scale output shorted to $V_{SS}$	40			mA
		Zero-scale output shorted to $V_{CC}$	40			
	Load regulation	Midscale code, $-15\text{ mA} \leq I_{OUT} \leq 15\text{ mA}$	70			µV/mA
	Maximum capacitive load <sup>(3)</sup>	$R_{LOAD} = \text{open}$	0	1		nF
	DC output impedance	Midscale code	0.05			Ω
		Full-scale code	40			
<b>DYNAMIC PERFORMANCE</b>						
	Output voltage settling time	¼ to ¾ scale and ¾ to ¼ scale settling time to ±1 LSB, ±10-V range, $R_L = 5\text{ k}\Omega$ , $C_L = 200\text{ pF}$	12			µs
	Slew rate	0-V to 5-V range	1			V/µs
		All other output ranges	4			
	Power-on glitch magnitude	Power-down to active DAC output, ±20 V range, midscale code, $R_L = 5\text{ k}\Omega$ , $C_L = 200\text{ pF}$	0.3			V
	Output noise	0.1 Hz to 10 Hz, midscale code, 0-V to 5-V range	15			µVpp
	Output noise density	1 kHz, midscale code, 0-V to 5-V range	78			nV/Hz
PSRR-AC	Power supply ac rejection ratio	Midscale code, frequency = 60 Hz, amplitude = 200 mVpp superimposed on $V_{DD}$ , $V_{CC}$ or $V_{SS}$	1			LSB/V
PSRR-DC	Power supply dc rejection ratio	Midscale code, $V_{DD} = 5\text{ V} \pm 5\%$ , $V_{CC} = 20\text{ V}$ , $V_{SS} = -20\text{ V}$	1			LSB/V
		Midscale code, $V_{DD} = 5\text{ V}$ , $V_{CC} = 20\text{ V} \pm 5\%$ , $V_{SS} = -20\text{ V}$	1			
		Midscale code, $V_{DD} = 5\text{ V}$ , $V_{CC} = 20\text{ V}$ , $V_{SS} = -20\text{ V} \pm 5\%$	1			
	Code change glitch impulse	1-LSB change around major carrier, 0-V to 5-V range	4			nV-s
	Channel-to-channel ac crosstalk	0-V to 5-V range, measured channel at midscale, full-scale swing on all other channels	4			nV-s
	Channel-to-channel dc crosstalk	0-V to 5-V range, measured channel at midscale, all other channels at full-scale	0.25			LSB
	Digital feedthrough	0-V to 5-V range, midscale code, $f_{SCLK} = 1\text{ MHz}$	1			nV-s

## 7.5 Electrical Characteristics (continued)

all minimum/maximum specifications at  $T_A = -40^\circ\text{C}$  to  $+125^\circ\text{C}$  and all typical specifications at  $T_A = 25^\circ\text{C}$ ,  $V_{CC} = 9\text{ V}$  to  $41.5\text{ V}$ ,  $V_{SS} = -21.5\text{ V}$  to  $0\text{ V}$ ,  $V_{DD} = V_{AA} = 4.5\text{ V}$  to  $5.5\text{ V}$ ,  $V_{REFIN} = 2.5\text{ V}$ ,  $V_{IO} = 1.7\text{ V}$  to  $5.5\text{ V}$ , DAC outputs unloaded, digital inputs at  $V_{IO}$  or GND (unless otherwise noted)

PARAMETER		TEST CONDITIONS	MIN	TYP	MAX	UNIT
<b>EXTERNAL REFERENCE INPUT</b>						
$V_{REFIN}$	Reference input voltage range	To $V_{REFGND}$	2.49	2.5	2.51	V
	Reference input current			50		$\mu\text{A}$
	Reference input impedance			50		$\text{k}\Omega$
	Reference input capacitance			20		$\text{pF}$
<b>INTERNAL REFERENCE</b>						
$V_{REFOUT}$	Reference output voltage range	$T_A = 25^\circ\text{C}$	2.4975		2.5025	V
	Reference output drift			5	15	$\text{ppm}/^\circ\text{C}$
	Reference output impedance			0.1		$\Omega$
	Reference output noise	0.1 Hz to 10 Hz		12		$\mu\text{Vpp}$
	Reference output noise density	10 kHz, $\text{REF}_{LOAD} = 10\text{ nF}$		150		$\text{nV}/\text{Hz}$
	Reference load current			5		$\text{mA}$
	Reference load regulation	Source		80		$\mu\text{V}/\text{mA}$
	Reference line regulation			20		$\mu\text{V}/\text{V}$
	Reference output drift over time	$T_A = 25^\circ\text{C}$ , 1900 hours		250		$\mu\text{V}$
	Reference thermal hysteresis	First cycle		$\pm 700$		$\mu\text{V}$
		Additional cycle		$\pm 50$		
<b>DIGITAL INPUTS AND OUTPUTS</b>						
$V_{IH}$	High-level input voltage		$0.7 \times V_{IO}$			V
$V_{IL}$	Low-level input voltage				$0.3 \times V_{IO}$	V
	Input current			$\pm 2$		$\mu\text{A}$
	Input pin capacitance			2		$\text{pF}$
$V_{OH}$	High-level output voltage	$I_{OH} = 0.2\text{ mA}$	$V_{IO} - 0.2$			V
$V_{OL}$	Low-level output voltage	$I_{OL} = 0.2\text{ mA}$			0.4	V
	Output pin capacitance			5		$\text{pF}$
<b>ALARM OUTPUT</b>						
	Output pin capacitance			5		$\text{pF}$
$V_{OL}$	Low-level output voltage	$I_{LOAD} = -0.2\text{ mA}$			0.4	V
<b>TEMPERATURE OUTPUT</b>						
$V_{TEMPOUT,0C}$	Output voltage offset at $0^\circ\text{C}$			1.34		V
	Sensor gain			-4		$\text{mV}/^\circ\text{C}$



## 7.5 Electrical Characteristics (continued)

all minimum/maximum specifications at  $T_A = -40^\circ\text{C}$  to  $+125^\circ\text{C}$  and all typical specifications at  $T_A = 25^\circ\text{C}$ ,  $V_{CC} = 9\text{ V}$  to  $41.5\text{ V}$ ,  $V_{SS} = -21.5\text{ V}$  to  $0\text{ V}$ ,  $V_{DD} = V_{AA} = 4.5\text{ V}$  to  $5.5\text{ V}$ ,  $V_{REFIN} = 2.5\text{ V}$ ,  $V_{IO} = 1.7\text{ V}$  to  $5.5\text{ V}$ , DAC outputs unloaded, digital inputs at  $V_{IO}$  or GND (unless otherwise noted)

PARAMETER	TEST CONDITIONS	MIN	TYP	MAX	UNIT	
<b>POWER REQUIREMENTS</b>						
$I_{DD}$	$V_{DD}$ supply current	Active mode, internal reference enabled, full-scale code, $\pm 20\text{ V}$ output range, SPI static	0.05	0.5	mA	
		Active mode, internal reference disabled, full-scale code, $\pm 20\text{ V}$ output range, SPI static	0.05	0.5	mA	
		Power-down mode	0.05	0.5	mA	
$I_{AA}$	$V_{AA}$ supply current	Active mode, internal reference enabled, full-scale code, $\pm 20\text{ V}$ output range, SPI static	20	30	mA	
		Active mode, internal reference disabled, full-scale code, $\pm 20\text{ V}$ output range, SPI static	18	28	mA	
		Power-down mode	2	85	$\mu\text{A}$	
$I_{CC}$	$V_{CC}$ supply current	Active mode, internal reference enabled, full-scale code, $\pm 20\text{ V}$ output range, SPI static	10	25	mA	
		Active mode, internal reference disabled, full-scale code, $\pm 20\text{ V}$ output range, SPI static	10	25	mA	
		Power-down mode	10	30	$\mu\text{A}$	
$I_{SS}$	$V_{SS}$ supply current	Active mode, internal reference enabled, full-scale code, $\pm 20\text{ V}$ output range, SPI static	-15	-10	mA	
		Active mode, internal reference disabled, full-scale code, $\pm 20\text{ V}$ output range, SPI static	-15	-10	mA	
		Power-down mode	-30	-10	$\mu\text{A}$	
$I_{IO}$	$V_{IO}$ supply current	SCLK and SDI toggling at 50 MHz		350	500	$\mu\text{A}$

- (1) End point fit between codes. 16-bit: Code 256 to 65280, 14-bit: Code 128 to 16256, 12-bit: Code 32 to 4064.
- (2) Temporary overload condition protection. Junction temperature can be exceeded during current limit. Operation above the specified maximum junction temperature may impair device reliability.
- (3) Specified by design and characterization, not production tested.

## 7.6 Timing Requirements

over operating free-air temperature range (unless otherwise noted)

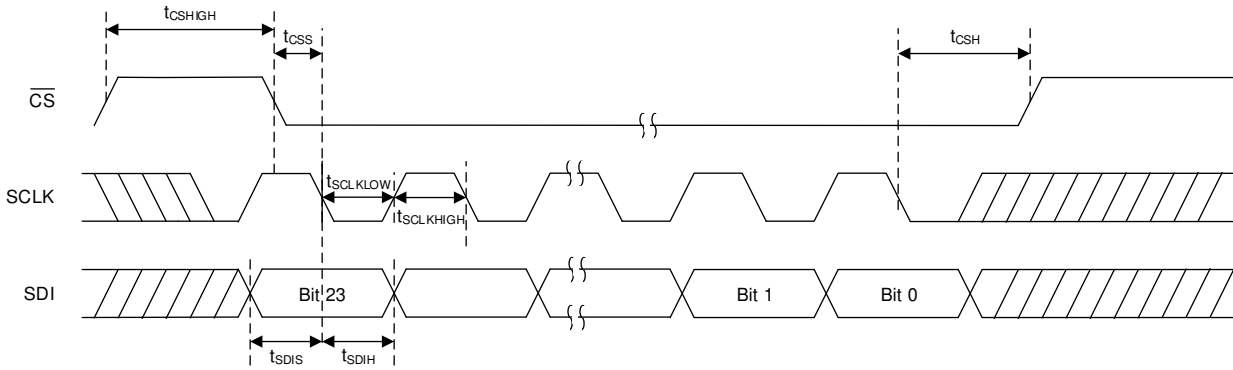
			MIN	NOM	MAX	UNIT
<b>SERIAL INTERFACE - WRITE OPERATION</b>						
f <sub>(SCLK)</sub>	Serial clock frequency	V <sub>IO</sub> = 1.7 V to 2.7 V			25	MHz
		V <sub>IO</sub> = 2.7 V to 5.5 V			50	
t <sub>SCLKHIGH</sub>	SCLK high time	V <sub>IO</sub> = 1.7 V to 2.7 V	20			ns
		V <sub>IO</sub> = 2.7 V to 5.5 V	10			
t <sub>SCLKLOW</sub>	SCLK low time	V <sub>IO</sub> = 1.7 V to 2.7 V	20			ns
		V <sub>IO</sub> = 2.7 V to 5.5 V	10			
t <sub>SDIS</sub>	SDI setup time	V <sub>IO</sub> = 1.7 V to 2.7 V	10			ns
		V <sub>IO</sub> = 2.7 V to 5.5 V	5			
t <sub>SDIH</sub>	SDI hold time	V <sub>IO</sub> = 1.7 V to 2.7 V	10			ns
		V <sub>IO</sub> = 2.7 V to 5.5 V	5			
t <sub>CSS</sub>	$\overline{\text{CS}}$ to SCLK falling edge setup time	V <sub>IO</sub> = 1.7 V to 2.7 V	30			ns
		V <sub>IO</sub> = 2.7 V to 5.5 V	15			
t <sub>CSH</sub>	SCLK falling edge to $\overline{\text{CS}}$ rising edge	V <sub>IO</sub> = 1.7 V to 2.7 V	10			ns
		V <sub>IO</sub> = 2.7 V to 5.5 V	5			
t <sub>CSHIGH</sub>	$\overline{\text{CS}}$ high time	V <sub>IO</sub> = 1.7 V to 2.7 V	50			ns
		V <sub>IO</sub> = 2.7 V to 5.5 V	25			
t <sub>DACWAIT</sub>	Sequential DAC update wait time	V <sub>IO</sub> = 1.7 V to 2.7 V	2.4			µs
		V <sub>IO</sub> = 2.7 V to 5.5 V	2.4			
t <sub>BCASTWAIT</sub>	Broadcast DAC update wait time	V <sub>IO</sub> = 1.7 V to 2.7 V	4			µs
		V <sub>IO</sub> = 2.7 V to 5.5 V	4			
<b>SERIAL INTERFACE - READ AND DAISY CHAIN OPERATION, FSDO = 0</b>						
f <sub>(SCLK)</sub>	Serial clock frequency	V <sub>IO</sub> = 1.7 V to 2.7 V			15	MHz
		V <sub>IO</sub> = 2.7 V to 5.5 V			20	
t <sub>SCLKHIGH</sub>	SCLK high time	V <sub>IO</sub> = 1.7 V to 2.7 V	33			ns
		V <sub>IO</sub> = 2.7 V to 5.5 V	25			
t <sub>SCLKLOW</sub>	SCLK low time	V <sub>IO</sub> = 1.7 V to 2.7 V	33			ns
		V <sub>IO</sub> = 2.7 V to 5.5 V	25			
t <sub>SDIS</sub>	SDI setup time	V <sub>IO</sub> = 1.7 V to 2.7 V	10			ns
		V <sub>IO</sub> = 2.7 V to 5.5 V	5			
t <sub>SDIH</sub>	SDI hold time	V <sub>IO</sub> = 1.7 V to 2.7 V	10			ns
		V <sub>IO</sub> = 2.7 V to 5.5 V	5			
t <sub>CSS</sub>	$\overline{\text{CS}}$ to SCLK falling edge setup time	V <sub>IO</sub> = 1.7 V to 2.7 V	30			ns
		V <sub>IO</sub> = 2.7 V to 5.5 V	20			
t <sub>CSH</sub>	SCLK falling edge to $\overline{\text{CS}}$ rising edge	V <sub>IO</sub> = 1.7 V to 2.7 V	8			ns
		V <sub>IO</sub> = 2.7 V to 5.5 V	5			
t <sub>CSHIGH</sub>	$\overline{\text{CS}}$ high time	V <sub>IO</sub> = 1.7 V to 2.7 V	50			ns
		V <sub>IO</sub> = 2.7 V to 5.5 V	25			
t <sub>SDOZD</sub>	SDO tri-state to driven	V <sub>IO</sub> = 1.7 V to 2.7 V	0		20	ns
		V <sub>IO</sub> = 2.7 V to 5.5 V	0		20	
t <sub>SDODLY</sub>	SDO output delay	V <sub>IO</sub> = 1.7 V to 2.7 V	0		35	ns
		V <sub>IO</sub> = 2.7 V to 5.5 V	0		20	

## 7.6 Timing Requirements (continued)

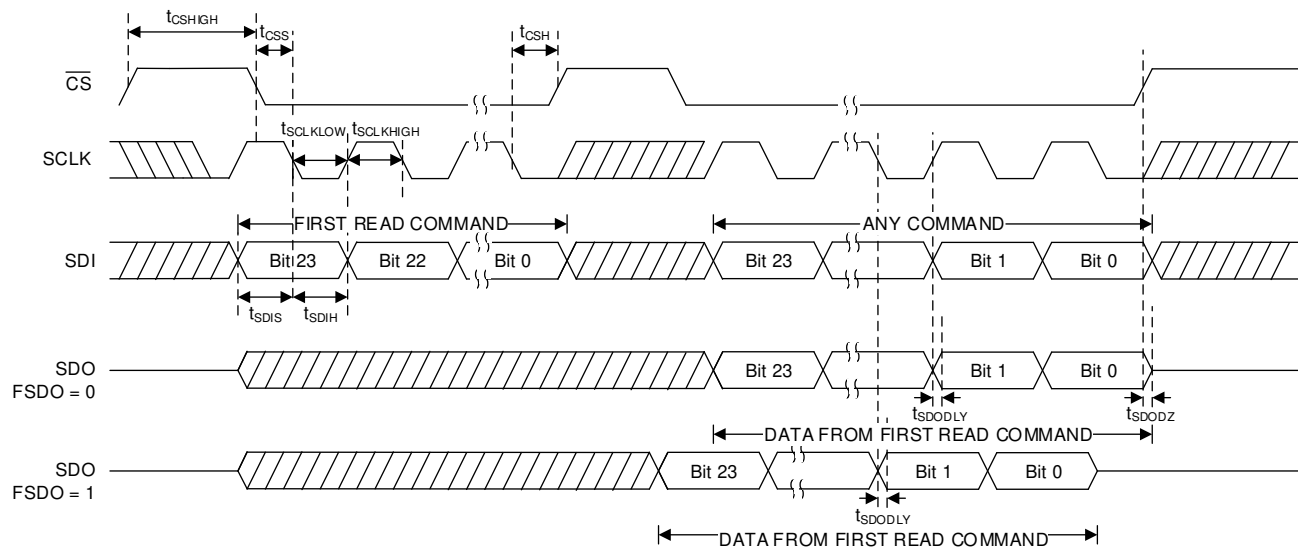
over operating free-air temperature range (unless otherwise noted)

			MIN	NOM	MAX	UNIT
<b>SERIAL INTERFACE - READ AND DAISY CHAIN OPERATION, FSDO = 1</b>						
f <sub>(SCLK)</sub>	Serial clock frequency	V <sub>IO</sub> = 1.7 V to 2.7 V			25	MHz
		V <sub>IO</sub> = 2.7 V to 5.5 V			35	
t <sub>SCLKHIGH</sub>	SCLK high time	V <sub>IO</sub> = 1.7 V to 2.7 V	20			ns
		V <sub>IO</sub> = 2.7 V to 5.5 V	14			
t <sub>SCLKLOW</sub>	SCLK low time	V <sub>IO</sub> = 1.7 V to 2.7 V	20			ns
		V <sub>IO</sub> = 2.7 V to 5.5 V	14			
t <sub>SDIS</sub>	SDI setup time	V <sub>IO</sub> = 1.7 V to 2.7 V	10			ns
		V <sub>IO</sub> = 2.7 V to 5.5 V	5			
t <sub>SDIH</sub>	SDI hold time	V <sub>IO</sub> = 1.7 V to 2.7 V	10			ns
		V <sub>IO</sub> = 2.7 V to 5.5 V	5			
t <sub>CSS</sub>	$\overline{\text{CS}}$ to SCLK falling edge setup time	V <sub>IO</sub> = 1.7 V to 2.7 V	30			ns
		V <sub>IO</sub> = 2.7 V to 5.5 V	20			
t <sub>CSH</sub>	SCLK falling edge to $\overline{\text{CS}}$ rising edge	V <sub>IO</sub> = 1.7 V to 2.7 V	8			ns
		V <sub>IO</sub> = 2.7 V to 5.5 V	5			
t <sub>CSHIGH</sub>	$\overline{\text{CS}}$ high time	V <sub>IO</sub> = 1.7 V to 2.7 V	50			ns
		V <sub>IO</sub> = 2.7 V to 5.5 V	25			
t <sub>SDOZD</sub>	SDO tri-state to driven	V <sub>IO</sub> = 1.7 V to 2.7 V	0		20	ns
		V <sub>IO</sub> = 2.7 V to 5.5 V	0		20	
t <sub>SDODLY</sub>	SDO output delay	V <sub>IO</sub> = 1.7 V to 2.7 V	0		35	ns
		V <sub>IO</sub> = 2.7 V to 5.5 V	0		20	
<b>DIGITAL LOGIC</b>						
t <sub>LOGDLY</sub>	$\overline{\text{CS}}$ rising edge to $\overline{\text{LDAC}}$ or $\overline{\text{CLR}}$ falling edge delay time	V <sub>IO</sub> = 1.7 V to 2.7 V	40			ns
t <sub>LOGDLY</sub>	$\overline{\text{CS}}$ rising edge to $\overline{\text{LDAC}}$ or $\overline{\text{CLR}}$ falling edge delay time	V <sub>IO</sub> = 2.7 V to 5.5 V	20			
t <sub>LDAC</sub>	$\overline{\text{LDAC}}$ low time	V <sub>IO</sub> = 1.7 V to 2.7 V	20			ns
		V <sub>IO</sub> = 2.7 V to 5.5 V	10			
t <sub>CLR</sub>	$\overline{\text{CLR}}$ low time	V <sub>IO</sub> = 1.7 V to 2.7 V	20			ns
		V <sub>IO</sub> = 2.7 V to 5.5 V	10			
t <sub>RESET</sub>	POR reset delay	V <sub>IO</sub> = 1.7 V to 2.7 V			1	ms
		V <sub>IO</sub> = 2.7 V to 5.5 V			1	
f <sub>TOGGLE</sub>	TOGGLE frequency	V <sub>IO</sub> = 1.7 V to 2.7 V			100	kHz
		V <sub>IO</sub> = 2.7 V to 5.5 V			100	

## 7.7 Timing Diagrams



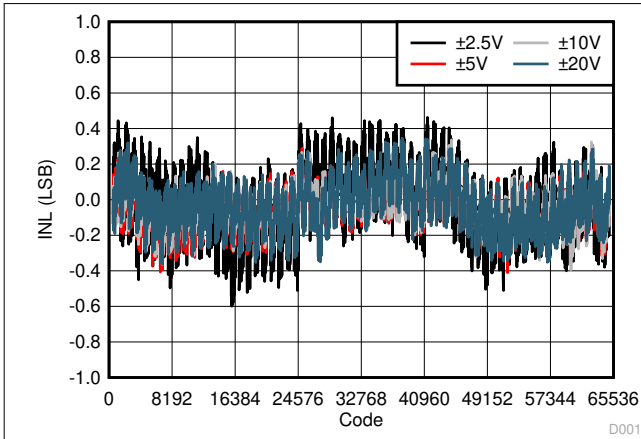
**Figure 7-1. Serial Interface Write Timing Diagram**



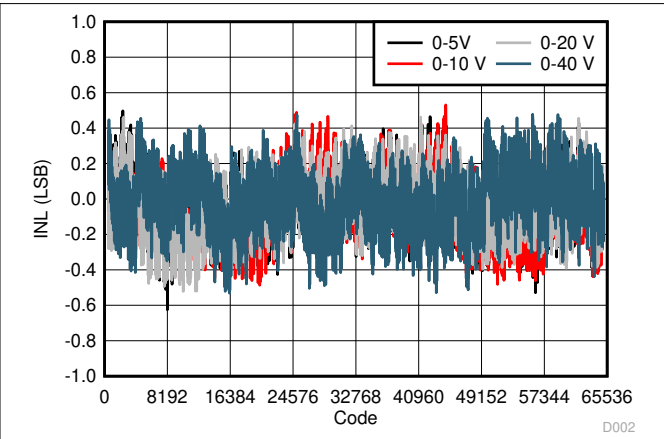
**Figure 7-2. Serial Interface Read Timing Diagram**

## 7.8 Typical Characteristics

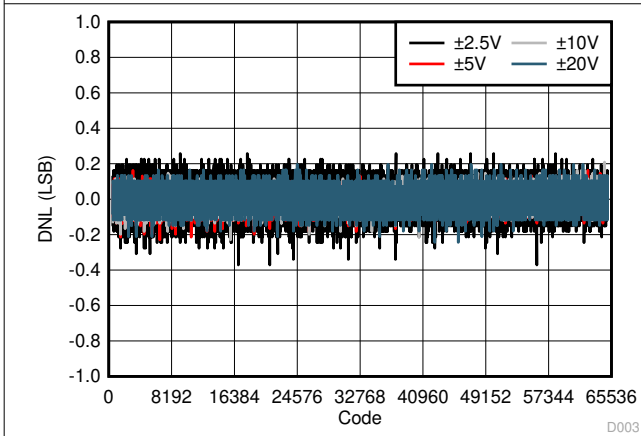
at  $T_A = 25^\circ\text{C}$ ,  $V_{DD} = V_{AA} = 5\text{ V}$ ,  $V_{REFIN} = 2.5\text{ V}$ , unipolar ranges:  $V_{SS} = 0\text{ V}$  and  $V_{CC} \geq V_{MAX} + 1.5\text{ V}$  for the DAC range, bipolar ranges:  $V_{SS} \leq V_{MIN} - 1.5\text{ V}$  and  $V_{CC} \geq V_{MAX} + 1.5\text{ V}$  for the DAC range, and DAC outputs unloaded (unless otherwise noted)



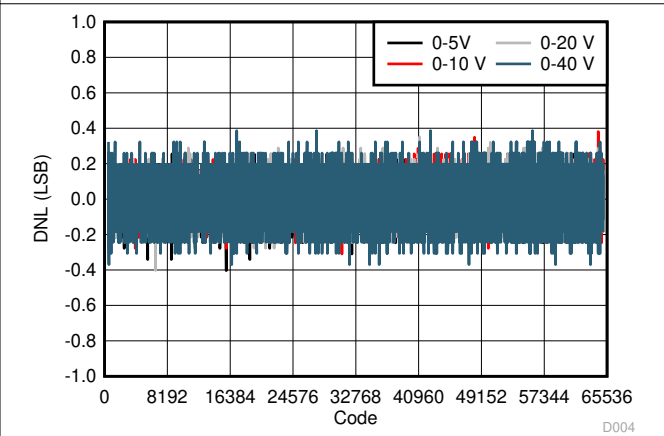
**Figure 7-3. Integral Linearity Error vs Digital Input Code (Bipolar Outputs)**



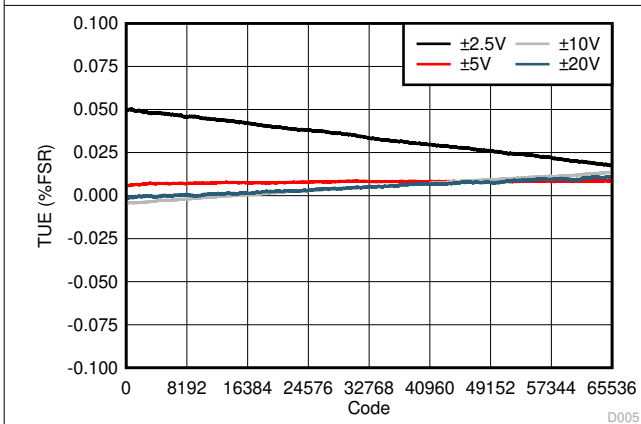
**Figure 7-4. Integral Linearity Error vs Digital Input Code (Unipolar Outputs)**



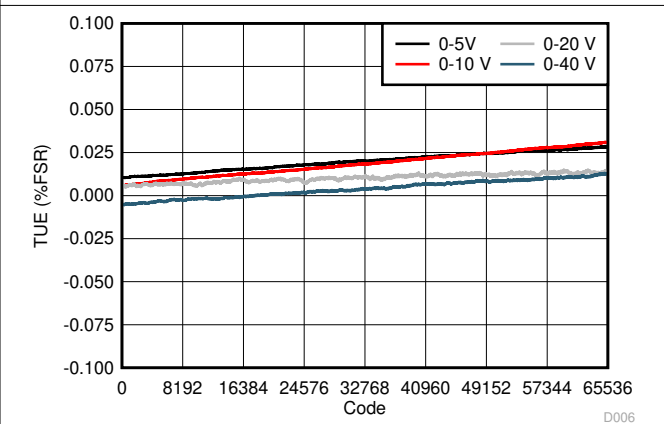
**Figure 7-5. Differential Linearity Error vs Digital Input Code (Bipolar Outputs)**



**Figure 7-6. Differential Linearity Error vs Digital Input Code (Unipolar Outputs)**



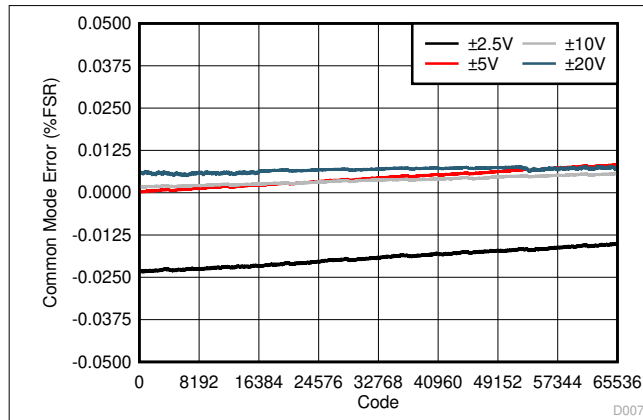
**Figure 7-7. Total Unadjusted Error vs Digital Input Code (Bipolar Outputs)**



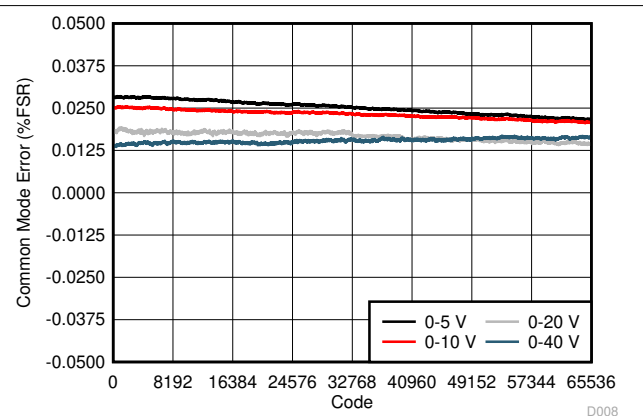
**Figure 7-8. Total Unadjusted Error vs Digital Input Code (Unipolar Outputs)**

## 7.8 Typical Characteristics (continued)

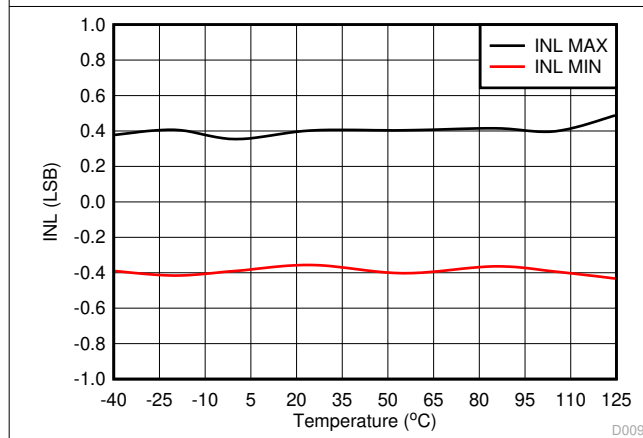
at  $T_A = 25^\circ\text{C}$ ,  $V_{DD} = V_{AA} = 5\text{ V}$ ,  $V_{REFIN} = 2.5\text{ V}$ , unipolar ranges:  $V_{SS} = 0\text{ V}$  and  $V_{CC} \geq V_{MAX} + 1.5\text{ V}$  for the DAC range, bipolar ranges:  $V_{SS} \leq V_{MIN} - 1.5\text{ V}$  and  $V_{CC} \geq V_{MAX} + 1.5\text{ V}$  for the DAC range, and DAC outputs unloaded (unless otherwise noted)



**Figure 7-9. Common Mode Error vs Digital Input Code (Differential Bipolar Outputs)**

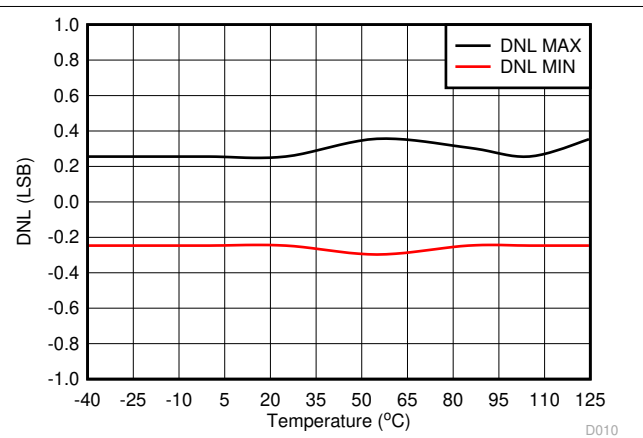


**Figure 7-10. Common Mode Error vs Digital Input Code (Differential Unipolar Outputs)**



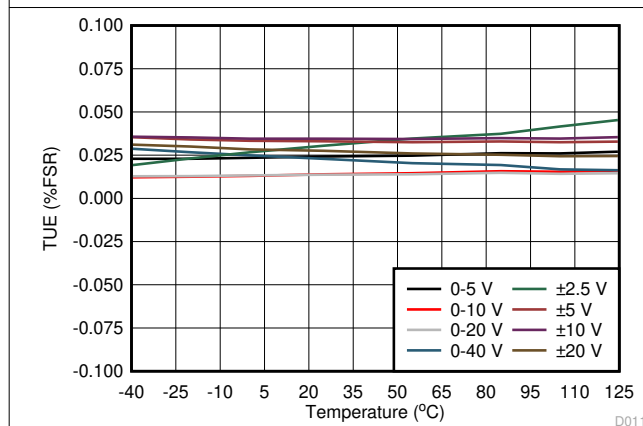
±20-V output range

**Figure 7-11. Integral Linearity Error vs Temperature**

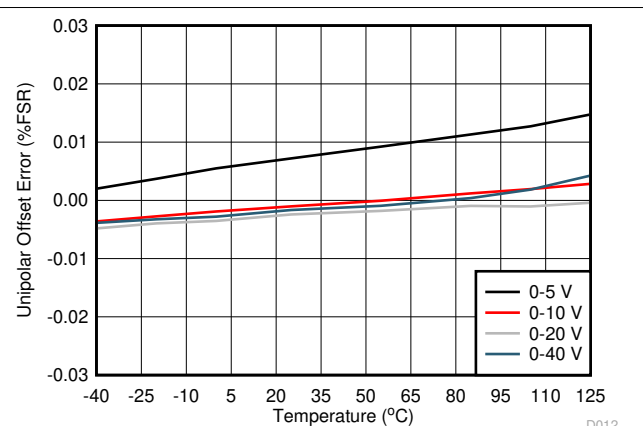


±20-V output range

**Figure 7-12. Differential Linearity Error vs Temperature**



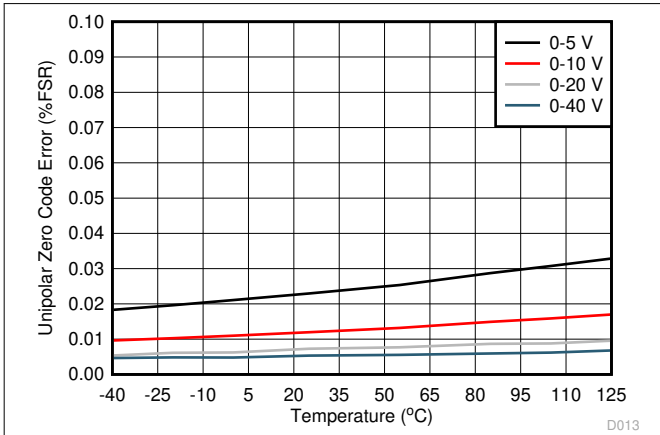
**Figure 7-13. Total Unadjusted Error vs Temperature**



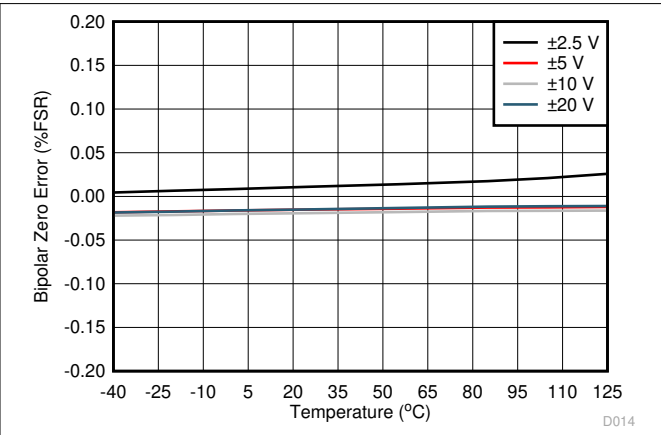
**Figure 7-14. Unipolar Offset Error vs Temperature**

### 7.8 Typical Characteristics (continued)

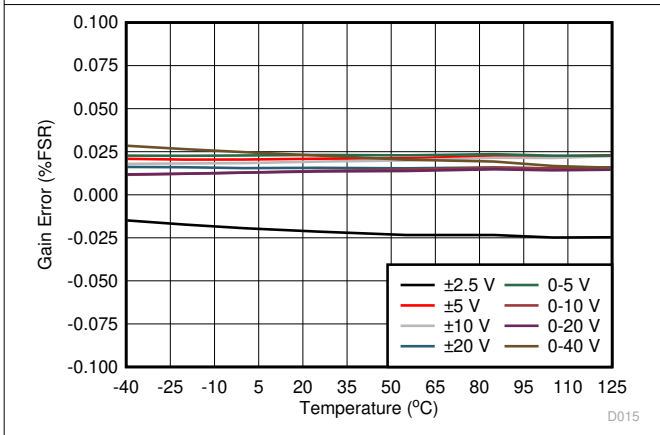
at  $T_A = 25^\circ\text{C}$ ,  $V_{DD} = V_{AA} = 5\text{ V}$ ,  $V_{REFIN} = 2.5\text{ V}$ , unipolar ranges:  $V_{SS} = 0\text{ V}$  and  $V_{CC} \geq V_{MAX} + 1.5\text{ V}$  for the DAC range, bipolar ranges:  $V_{SS} \leq V_{MIN} - 1.5\text{ V}$  and  $V_{CC} \geq V_{MAX} + 1.5\text{ V}$  for the DAC range, and DAC outputs unloaded (unless otherwise noted)



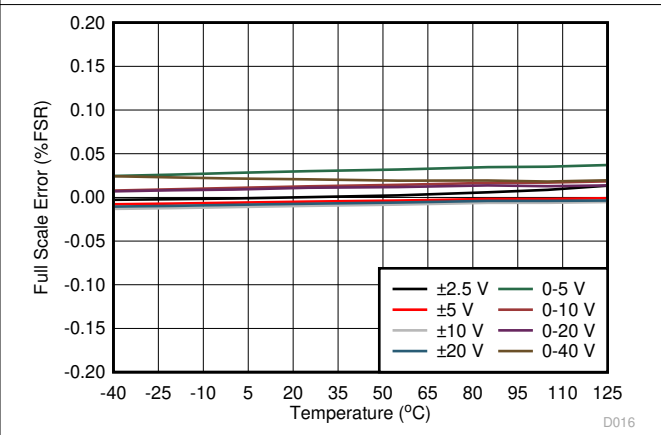
**Figure 7-15. Unipolar Zero Code Error vs Temperature**



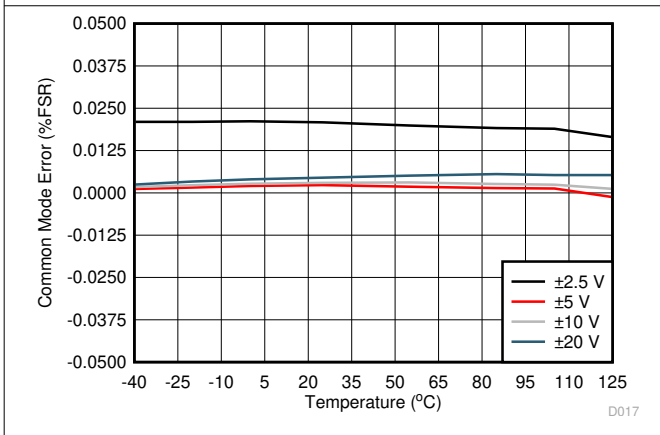
**Figure 7-16. Bipolar Zero Error vs Temperature**



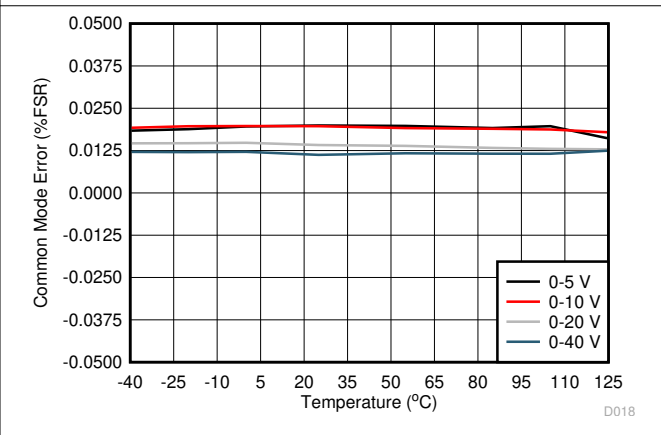
**Figure 7-17. Gain Error vs Temperature**



**Figure 7-18. Full-Scale Error vs Temperature**



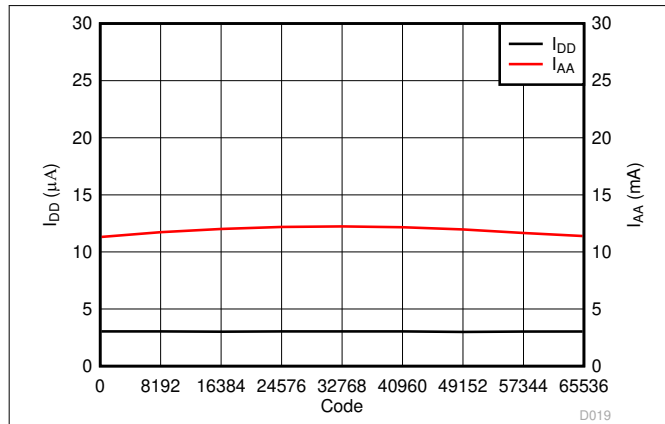
**Figure 7-19. Common Mode Error vs Temperature (Differential Bipolar Outputs)**



**Figure 7-20. Common Mode Error vs Temperature (Differential Unipolar Outputs)**

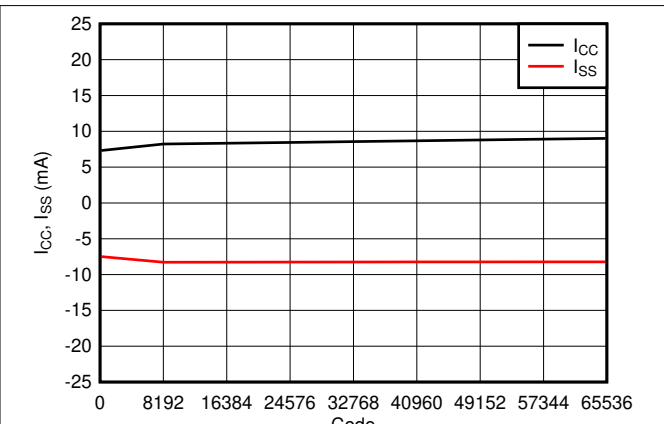
## 7.8 Typical Characteristics (continued)

at  $T_A = 25^\circ\text{C}$ ,  $V_{DD} = V_{AA} = 5\text{ V}$ ,  $V_{REFIN} = 2.5\text{ V}$ , unipolar ranges:  $V_{SS} = 0\text{ V}$  and  $V_{CC} \geq V_{MAX} + 1.5\text{ V}$  for the DAC range, bipolar ranges:  $V_{SS} \leq V_{MIN} - 1.5\text{ V}$  and  $V_{CC} \geq V_{MAX} + 1.5\text{ V}$  for the DAC range, and DAC outputs unloaded (unless otherwise noted)



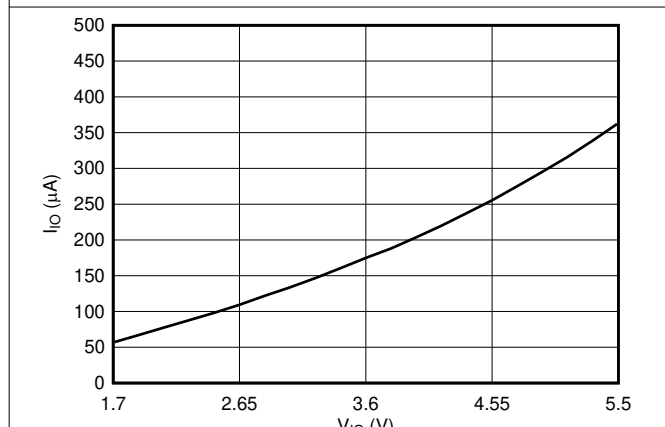
±20-V output range

**Figure 7-21. Supply Current ( $I_{DD}$ ,  $I_{AA}$ ) vs Digital Input Code**



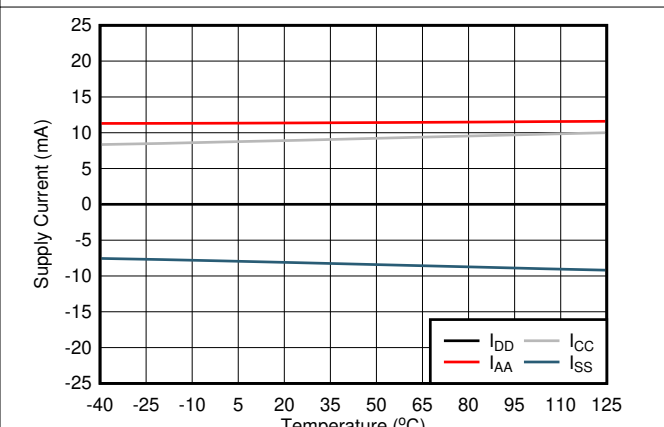
±20-V output range

**Figure 7-22. Supply Current ( $I_{CC}$ ,  $I_{SS}$ ) vs Digital Input Code**



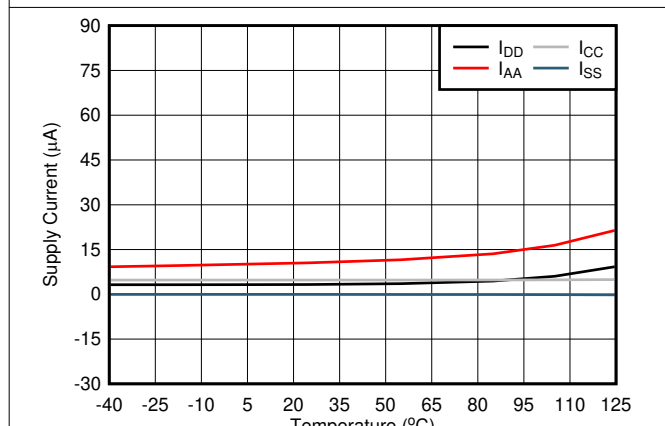
±20-V output range

**Figure 7-23. Supply Current ( $I_{IO}$ ) vs Supply Voltage**



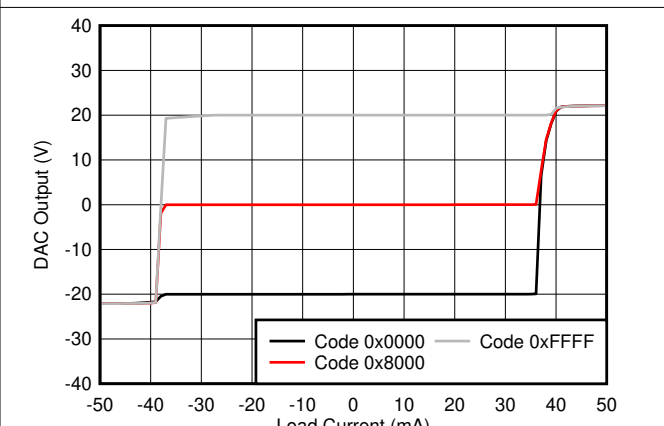
±20-V output range

**Figure 7-24. Supply Current vs Temperature**



±20-V output range

**Figure 7-25. Power-Down Current vs Temperature**



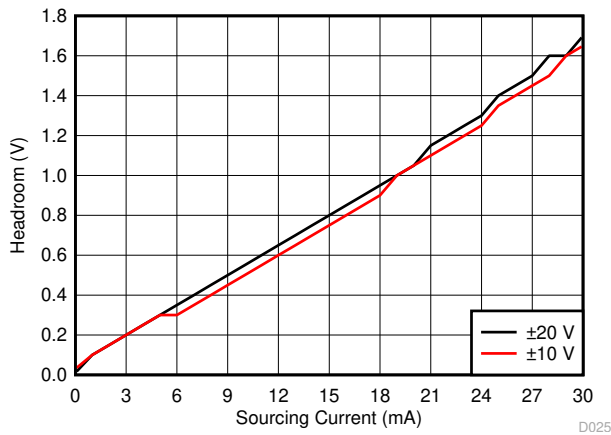
±20-V output range

**Figure 7-26. Source and Sink Capability**



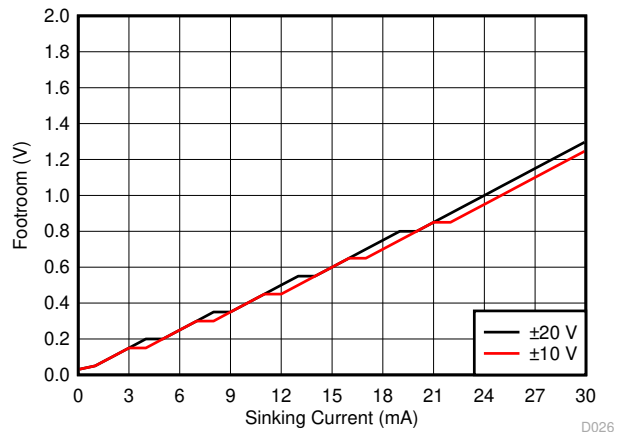
## 7.8 Typical Characteristics (continued)

at  $T_A = 25^\circ\text{C}$ ,  $V_{DD} = V_{AA} = 5\text{ V}$ ,  $V_{REFIN} = 2.5\text{ V}$ , unipolar ranges:  $V_{SS} = 0\text{ V}$  and  $V_{CC} \geq V_{MAX} + 1.5\text{ V}$  for the DAC range, bipolar ranges:  $V_{SS} \leq V_{MIN} - 1.5\text{ V}$  and  $V_{CC} \geq V_{MAX} + 1.5\text{ V}$  for the DAC range, and DAC outputs unloaded (unless otherwise noted)



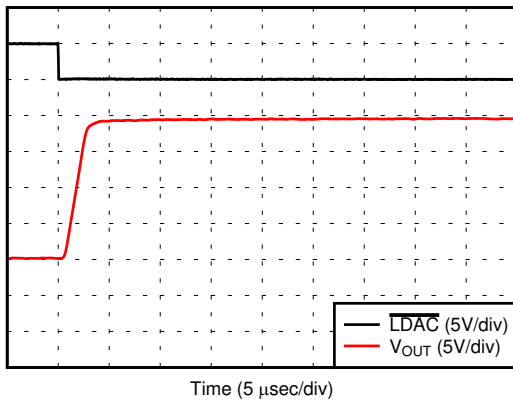
Full-scale code

**Figure 7-27.  $V_{CC}$  Headroom vs Sourcing Current**



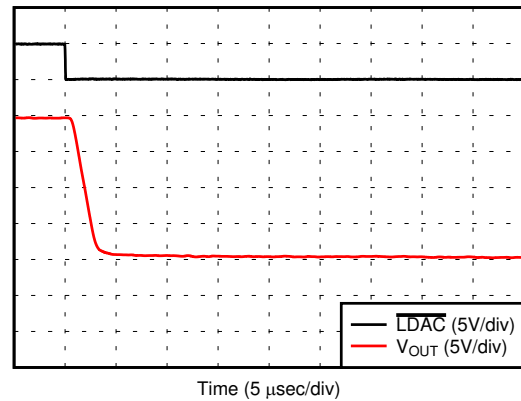
Zero code

**Figure 7-28.  $V_{SS}$  Footroom vs Sinking Current**



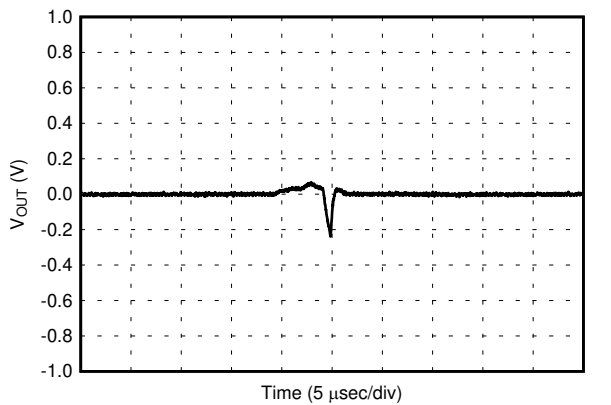
±20-V output range

**Figure 7-29. Full-Scale Settling Time, Rising Edge**



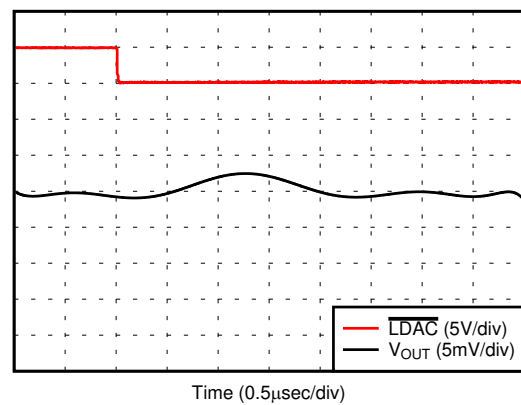
±20-V output range

**Figure 7-30. Full-Scale Settling Time, Falling Edge**



Power-down to active DAC mode  
±20-V output range

**Figure 7-31. DAC Output Enable Glitch**

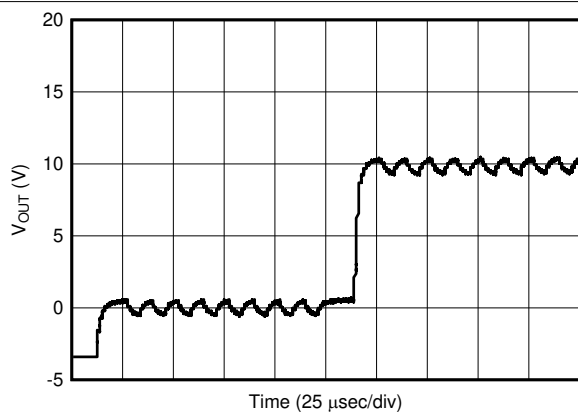


0-V to 5-V output range

**Figure 7-32. Glitch Impulse, 1 LSB Step**

## 7.8 Typical Characteristics (continued)

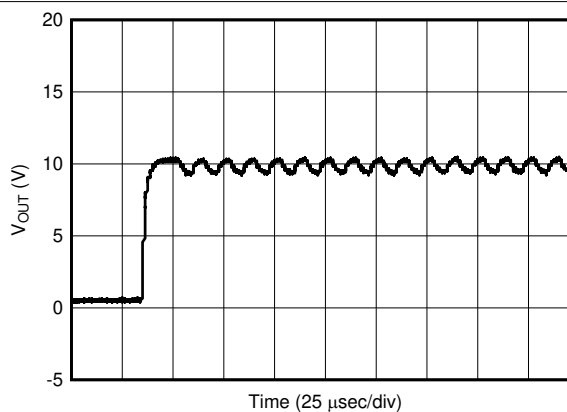
at  $T_A = 25^\circ\text{C}$ ,  $V_{DD} = V_{AA} = 5\text{ V}$ ,  $V_{REFIN} = 2.5\text{ V}$ , unipolar ranges:  $V_{SS} = 0\text{ V}$  and  $V_{CC} \geq V_{MAX} + 1.5\text{ V}$  for the DAC range, bipolar ranges:  $V_{SS} \leq V_{MIN} - 1.5\text{ V}$  and  $V_{CC} \geq V_{MAX} + 1.5\text{ V}$  for the DAC range, and DAC outputs unloaded (unless otherwise noted)



D031

±20-V output range  
 Toggle signal: 1  $V_{PP}$   
 DC change: midscale to 3/4 full-scale

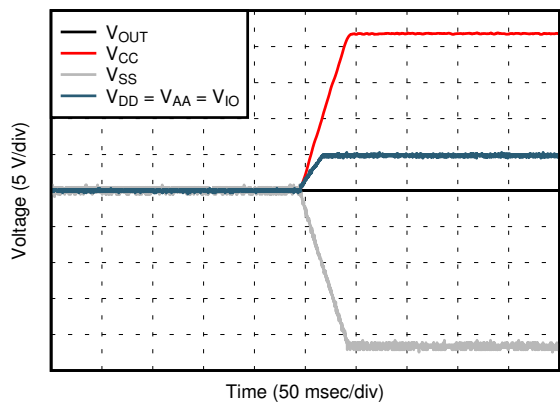
**Figure 7-33. Toggle Output Change Response**



D032

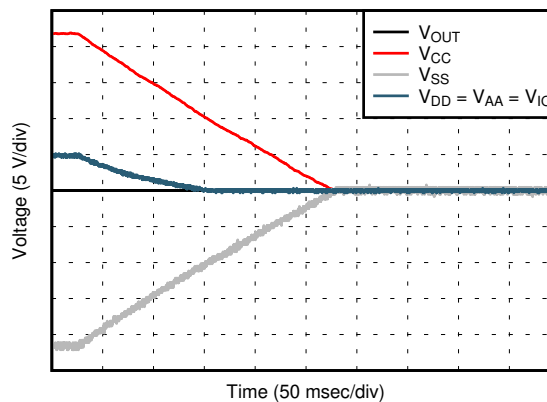
±20-V output range  
 Toggle signal: 1  $V_{PP}$   
 DC value: 3/4 full-scale

**Figure 7-34. Toggle Enable Response**



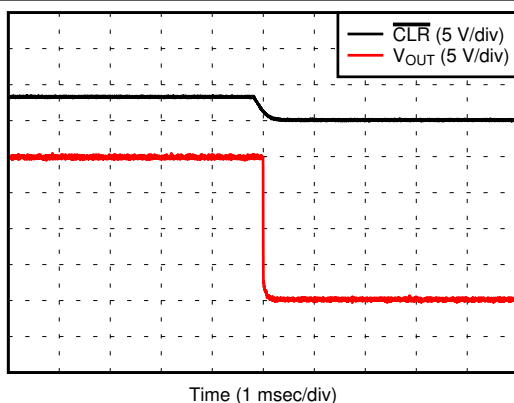
D033

**Figure 7-35. Power-Up Response**



D034

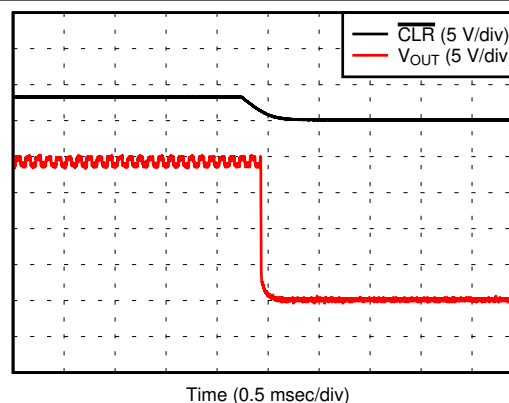
**Figure 7-36. Power-Down Response**



D035

±20-V output range  
 Full-scale code to 0 V

**Figure 7-37. Clear Command Response**



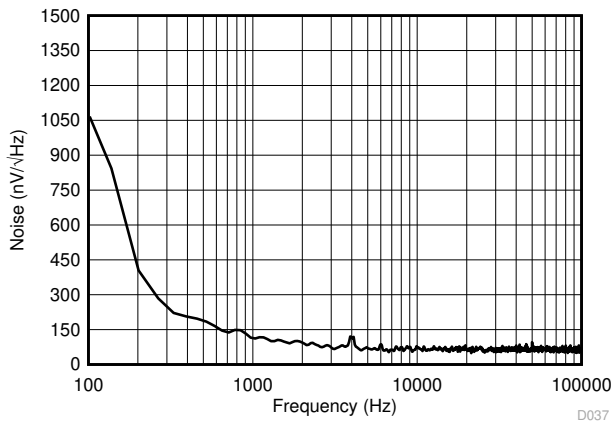
D036

±20-V output range  
 Toggle signal: 1  $V_{PP}$   
 DC value at 20 V

**Figure 7-38. Clear Command Response in Toggle Mode**

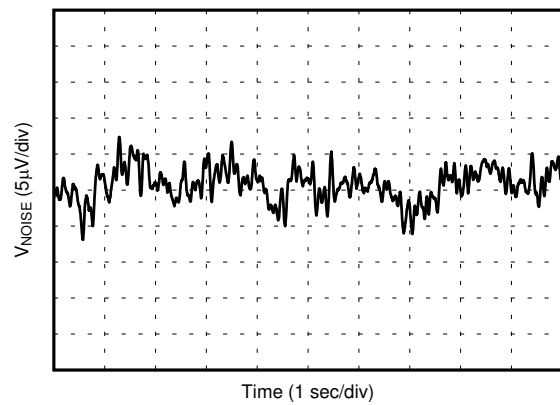
### 7.8 Typical Characteristics (continued)

at  $T_A = 25^\circ\text{C}$ ,  $V_{DD} = V_{AA} = 5\text{ V}$ ,  $V_{REFIN} = 2.5\text{ V}$ , unipolar ranges:  $V_{SS} = 0\text{ V}$  and  $V_{CC} \geq V_{MAX} + 1.5\text{ V}$  for the DAC range, bipolar ranges:  $V_{SS} \leq V_{MIN} - 1.5\text{ V}$  and  $V_{CC} \geq V_{MAX} + 1.5\text{ V}$  for the DAC range, and DAC outputs unloaded (unless otherwise noted)



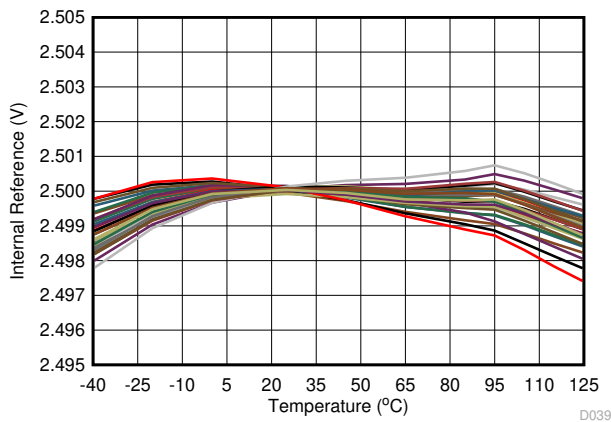
0 to 5-V output range  
Midscale code

**Figure 7-39. DAC Output Noise Density vs Frequency**

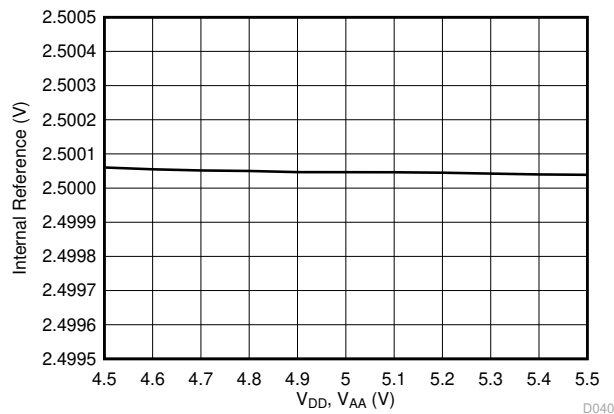


0 to 5-V output range  
Midscale code

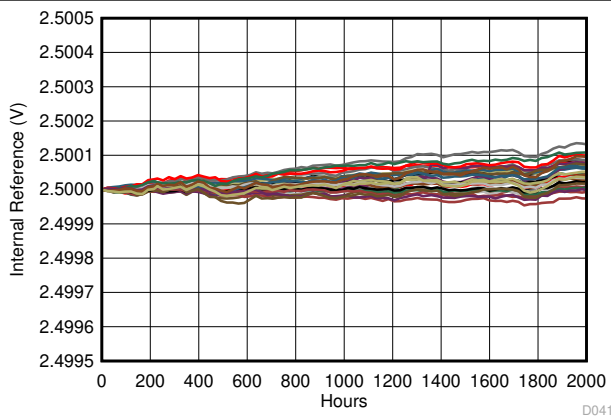
**Figure 7-40. DAC Output Noise**



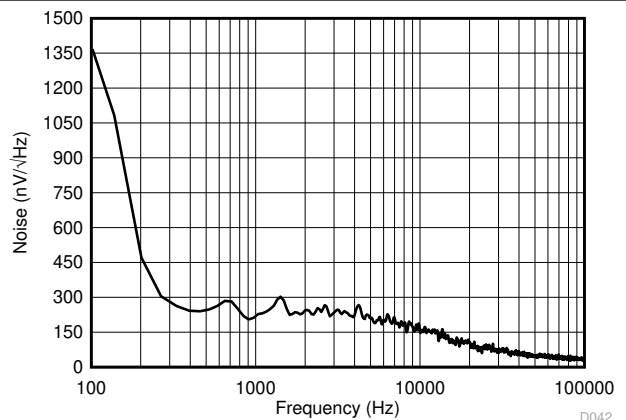
**Figure 7-41. Internal Reference Voltage vs Temperature**



**Figure 7-42. Internal Reference Voltage vs Supply Voltage**



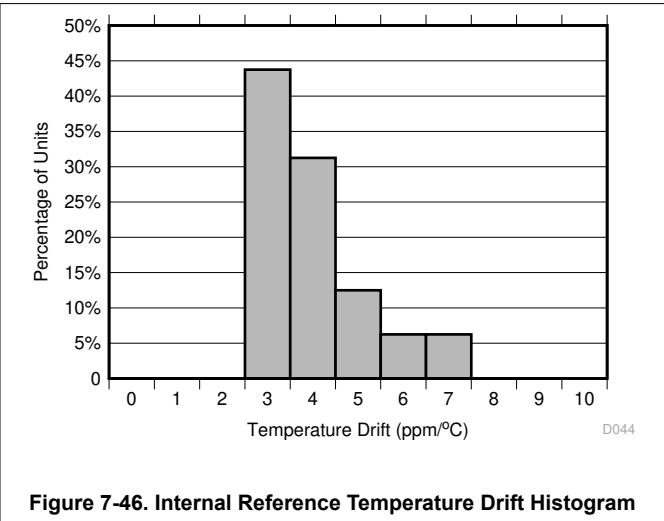
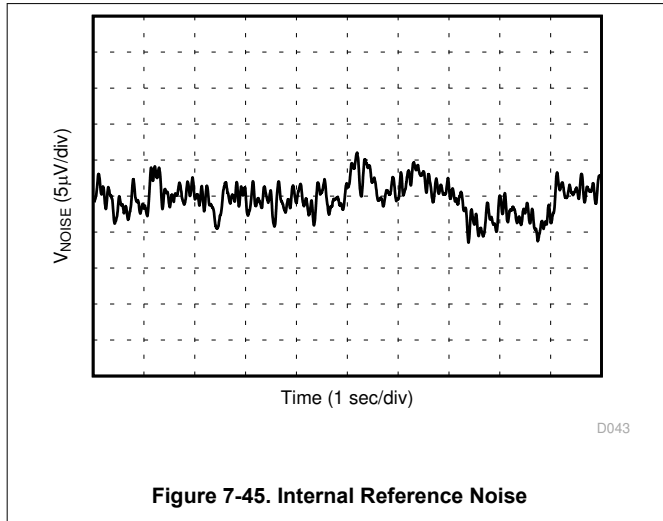
**Figure 7-43. Internal Reference Voltage vs Time**



**Figure 7-44. Internal Reference Noise Density vs Frequency**

## 7.8 Typical Characteristics (continued)

at  $T_A = 25^\circ\text{C}$ ,  $V_{DD} = V_{AA} = 5\text{ V}$ ,  $V_{REFIN} = 2.5\text{ V}$ , unipolar ranges:  $V_{SS} = 0\text{ V}$  and  $V_{CC} \geq V_{MAX} + 1.5\text{ V}$  for the DAC range, bipolar ranges:  $V_{SS} \leq V_{MIN} - 1.5\text{ V}$  and  $V_{CC} \geq V_{MAX} + 1.5\text{ V}$  for the DAC range, and DAC outputs unloaded (unless otherwise noted)



## 8 Detailed Description

### 8.1 Overview

The DACx1416 are a pin-compatible family of 16-channel, buffered, high-voltage output digital-to-analog converters (DACs) with 16-bit, 14-bit, and 12-bit resolution. The DACx1416 include a 2.5-V internal reference. A user-selectable output configuration enables full-scale bipolar output voltages of  $\pm 20$  V,  $\pm 10$  V,  $\pm 5$  V or  $\pm 2.5$  V, and full-scale unipolar output voltages of 40 V, 20 V, 10 V or 5 V. The full-scale output range for each DAC channel is independently programmable. In addition, each pair of DAC channels can be configured to provide a differential output. Three dedicated A-B toggle pins enable dither signal generation with up to three possible frequencies.

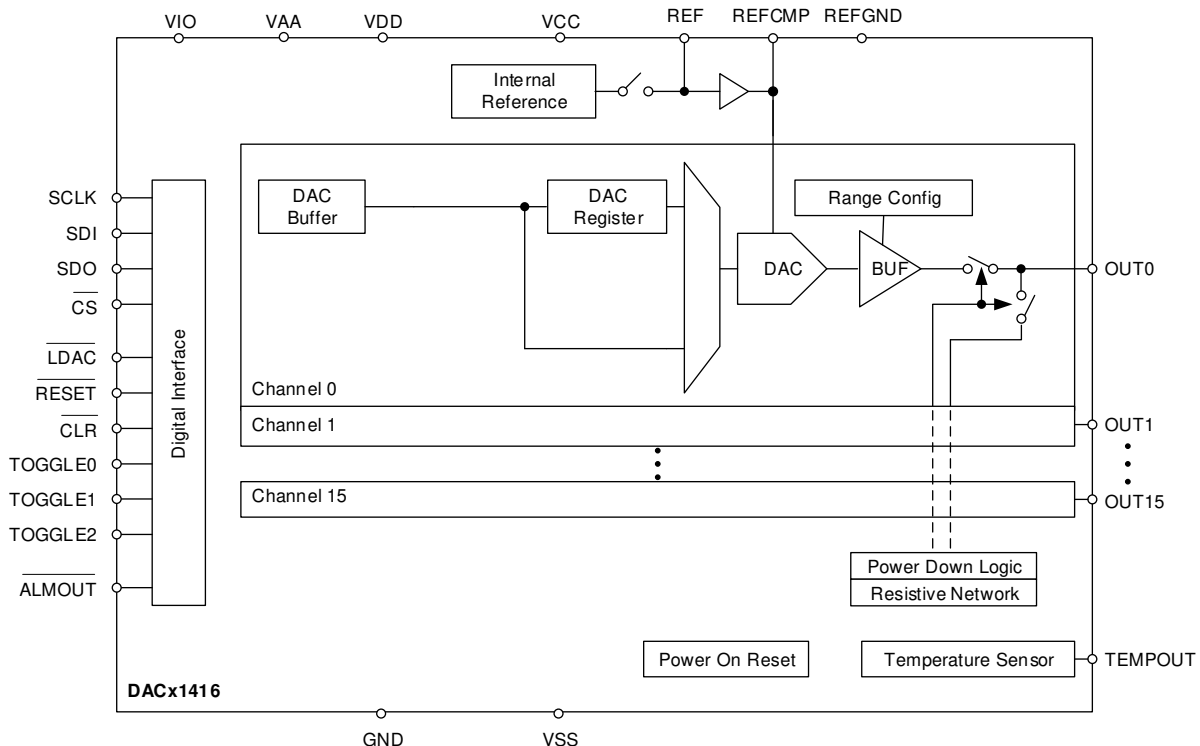
The DACx1416 operate from five supply voltages:  $V_{DD}$ ,  $V_{AA}$ ,  $V_{CC}$ ,  $V_{SS}$  and  $V_{IO}$ .

- $V_{DD}$  and  $V_{AA}$  are the digital and analog supplies for the DACs, internal reference and other low voltage components and must be set at the same potential.
- $V_{CC}$  and  $V_{SS}$  are the positive and analog supplies for the DAC output amplifiers.
- $V_{IO}$  sets the logic levels for the digital inputs and outputs.

Communication with the DACx1416 is performed through a 4-wire serial interface that supports stand-alone and daisy-chain operation. The optional frame-error checking provides added robustness to the DACx1416 serial interface.

The DACx1416 incorporate a power-on-reset circuit that connects the DAC outputs to ground at power up. The outputs remain in this state until the device registers are properly configured for operation.

### 8.2 Functional Block Diagram



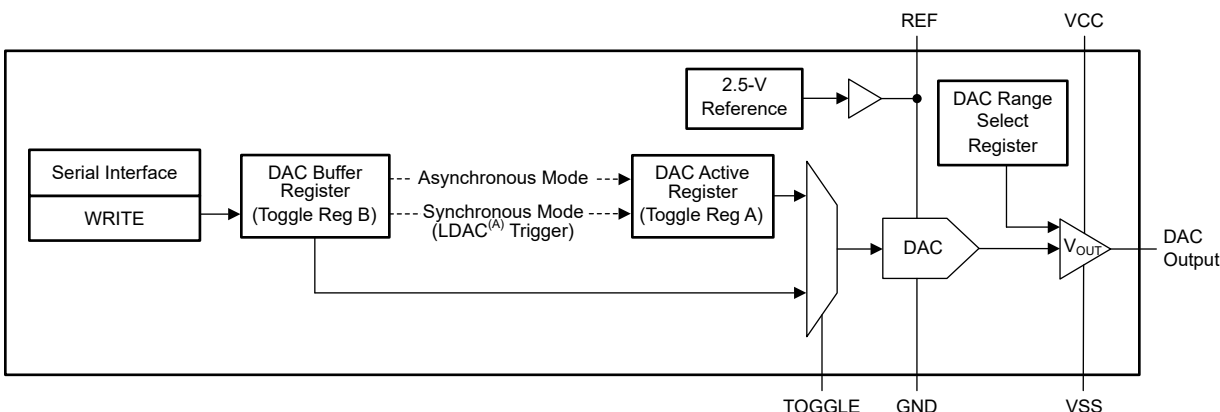
## 8.3 Feature Description

### 8.3.1 Digital-to-Analog Converter (DAC) Architecture

Each output channel in the DACx1416 consists of an R-2R ladder architecture followed by an output buffer amplifier capable of rail-to-rail operation. The output amplifiers can drive 25 mA with 1.5-V headroom from either  $V_{CC}$  or  $V_{SS}$  while maintaining the specified TUE specification for the device. The full-scale output voltage for each channel can be individually configured to the following ranges:

- –20 V to +20 V
- –10 V to +10 V
- –5 V to +5 V
- –2.5 V to +2.5 V
- 0 V to 40 V
- 0 V to 20 V
- 0 V to 10 V
- 0 V to 5 V

Figure 8-1 shows a block diagram of the DAC architecture.



- A. The DAC trigger is generated by either by writing 1 to the LDAC bit or by the  $\overline{\text{LDAC}}$  pin in synchronous mode. In asynchronous mode, the DAC latch is transparent.

**Figure 8-1. DACx1416 DAC Block Diagram**

#### 8.3.1.1 DAC Transfer Function

The input data are written to the individual DAC Data registers in straight binary format for all output ranges. The DAC transfer function is given by Equation 1.

$$V_{\text{OUT}} = \left( \frac{\text{CODE}}{2^n} \times \text{FSR} \right) + V_{\text{MIN}} \quad (1)$$

where:

- CODE is the decimal equivalent of the binary code that is loaded to the DAC register. CODE range is from 0 to  $2^n - 1$ .
- n is the DAC resolution in bits. Either 12 (DAC61416), 14 (DAC71416) or 16 (DAC81416).
- FSR is the DAC full-scale range. Equal to  $V_{\text{MAX}} - V_{\text{MIN}}$  for the selected DAC output range.
- $V_{\text{MIN}}$  is the lowest voltage for the selected DAC output range.

### 8.3.1.2 DAC Register Structure

Data written to the DAC data registers is initially stored in the DAC buffer registers. Transfer of data from the DAC buffer registers to the active DAC registers can be configured to happen immediately (asynchronous mode) or initiated by a DAC trigger signal (synchronous mode). Once the DAC active registers are updated, the DAC outputs change to the new values.

After a power-on or reset event, all DAC registers are set to zero code, the DAC output amplifiers are powered down, and the DAC outputs are clamped to ground.

#### 8.3.1.2.1 DAC Register Synchronous and Asynchronous Updates

The update mode for each DAC channel is determined by the status of its corresponding SYNC-EN bit. In asynchronous mode, a write to the DAC data register results in an immediate update of the DAC active register and DAC output on a  $\overline{CS}$  rising edge. In synchronous mode, writing to the DAC data register does not automatically update the DAC output. Instead the update occurs only after a trigger event. A DAC trigger signal is generated either through the LDAC bit or by the  $\overline{LDAC}$  pin. The synchronous update mode enables simultaneous update of multiple DAC outputs. In both update modes a minimum wait time of 1  $\mu$ s is required between DAC output updates.

#### 8.3.1.2.2 Broadcast DAC Register

The DAC broadcast register enables a simultaneous update of multiple DAC outputs with the same value with a single register write. Broadcast operation is only possible when all DAC channels are in single-ended mode operation. If one or more outputs are configured in differential mode the broadcast command is ignored.

Each DAC channel can be configured to update or remain unaffected by a broadcast command by setting the corresponding DAC-BROADCAST-EN bit. A register write to the BRDCAST-DATA register forces those DAC channels that have been configured for broadcast operation to update their DAC buffer registers to this value. The DAC outputs update to the broadcast value according to their synchronous mode configuration.

#### 8.3.1.2.3 Clear DAC Operation

The DAC outputs are set in clear mode through the  $\overline{CLR}$  pin. In clear mode each DAC data channel is set to the clear code associated with its configuration as shown in [Table 8-1](#). A  $\overline{CLR}$  pin logic low forces all DAC channels to clear the contents of their buffer and active registers to the clear code, and sets the analog outputs accordingly regardless of their synchronization setting.

**Table 8-1. Clear DAC Value**

UNIPOLAR / BIPOLAR RANGE	DIFFERENTIAL MODE	CLEAR CODE
Unipolar	No	Zero code
Unipolar	Yes	Midscale code
Bipolar	No	Midscale code
Bipolar	Yes	Midscale code

When a DAC is operating in toggle mode, a clear command sets both toggle registers to the clear value.

### 8.3.2 Internal Reference

The DAX1416 includes a precision 2.5-V bandgap reference with a typical temperature drift of 5 ppm/°C. The internal reference is externally available at the REF pin. An external buffer amplifier with a high impedance input is required to drive any external load.

A minimum 150-nF capacitor is recommended between the reference output and GND for noise filtering. A compensation capacitor (330 pF, typical) should be connected between the REFCMP pin and REFGND.

Operation from an external reference is also supported by powering down the internal reference. The external reference is applied to the REF pin.

### 8.3.3 Device Reset Options

#### 8.3.3.1 Power-on-Reset (POR)

The DACx1416 includes a power-on reset function. After the supplies have been established, a POR event is issued. The POR causes all registers to initialize to their default values and communication with the device is valid only after a 1-ms power-on-reset delay. After a POR event, the device is set in power-down mode where all DAC channels and internal reference are powered down and the DAC output pins are connected to ground through a 10-k $\Omega$  internal resistor.

#### 8.3.3.2 Hardware Reset

A device hardware reset event is initiated by a minimum 500 ns logic low on the  $\overline{\text{RESET}}$  pin. A hardware reset initiates a POR event.

#### 8.3.3.3 Software Reset

A device software reset event is initiated by writing the reserved code 0x1010 to SOFT-RESET in the TRIGGER register. The software reset command is triggered on the  $\overline{\text{CS}}$  rising edge of the instruction. A software reset initiates a POR event.

### 8.3.4 Thermal Protection

Because of the device DAC channel density and high drive capability, make sure that the effects of power dissipation on the device temperature are understood and that the device temperature does not exceed the maximum junction temperature.

#### 8.3.4.1 Analog Temperature Sensor: TEMPOUT Pin

The DACx1416 includes an analog temperature monitor with an unbuffered output voltage that is inversely proportional to the device junction temperature. The TEMPOUT pin output voltage has a temperature slope of  $-4 \text{ mV}/^\circ\text{C}$  and a 1.34-V offset as described by [Equation 2](#).

$$V_{\text{TEMPOUT}} = \left( \frac{-4 \text{ mV}}{^\circ\text{C}} \times T \right) + 1.34 \text{ V} \quad (2)$$

where:

- T is the device junction temperature in  $^\circ\text{C}$ .
- $V_{\text{TEMPOUT}}$  is the temperature monitor output voltage.

#### 8.3.4.2 Thermal Shutdown

The DACx1416 incorporates a thermal shutdown that is triggered when the die temperature exceeds  $140^\circ\text{C}$ . A thermal shutdown sets the TEMP-ALM bit and causes all DAC outputs to power-down, however the internal reference remains powered on. The  $\overline{\text{ALMOUT}}$  pin can be configured to monitor a thermal shutdown condition by setting the TEMPALM-EN bit. Once a thermal shutdown is triggered, the device stays in shutdown even after the device temperature lowers.

The die temperature must fall below  $140^\circ\text{C}$  before the device can be returned to normal operation. To resume normal operation, the thermal alarm must be cleared through the ALM-RESET bit while the DAC channels are in power-down mode.



## 8.4 Device Functional Modes

### 8.4.1 Toggle Mode

Each DAC in the device can be independently configured to operate in toggle mode. A DAC channel in toggle mode incorporates two DAC registers (Register A and Register B) and can be set to switch repetitively between these two values. The DACx1416 toggle mode operation can be configured to introduce a dither signal to the DAC output, to generate a periodic signal or to implement ON/OFF signaling, among some examples.

To update the toggle registers the following sequence should be followed:

1. Set DAC channel in synchronous mode and disable toggle mode for that channel
2. Write the desired Register A value to the DAC data register
3. Issue a DAC trigger signal to load Register A
4. Write the desired Register B value to the DAC data register
5. Enable toggle mode to load Register B

Once both registers are loaded with data, any of the three TOGGLE[2:0] pins can be used to switch those DACs configured for toggle operation back and forth between the contents of their two DAC specific registers by using an external clock or logic signal. A TOGGLE pin logic low updates the DAC output to the value set by Register A. A logic high updates the DAC output to the value set by Register B. The three TOGGLE[2:0] pins give the DACx1416 the option to operate with up to three toggle rates.

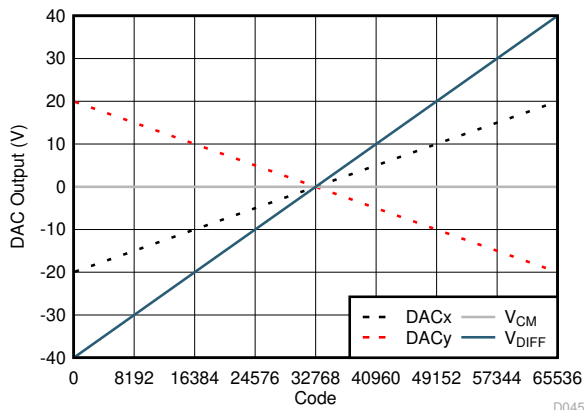
Additionally, the device can be configured for software controlled toggle operation by setting the SOFTTOGGLE-EN bit. In this mode, any of the three AB-TOG[2:0] bits can be used as a toggle control signal. Setting the AB-TOG bit to 1 enables Register B and clearing it to 0 enables Register A.

### 8.4.2 Differential Mode

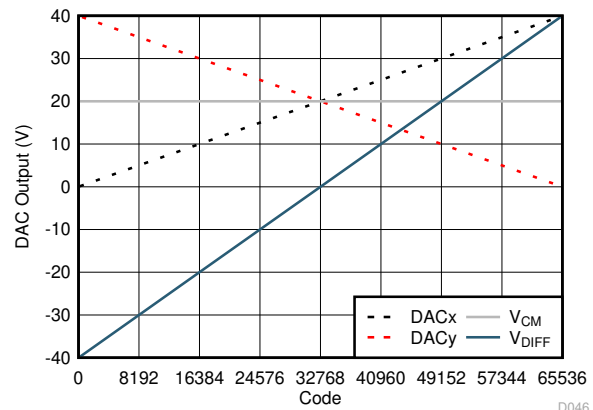
Each DAC pair in the device, can be independently configured to operate as a differential output pair. The differential output of a DACx-y pair is updated by writing to the DACx channel. For proper operation, the two DAC pairs must be configured to the same output range prior to enabling differential mode. Figure 8-2 and Figure 8-3 show the ideal differential output voltages ( $V_{DIFF}$ ) and common mode voltages ( $V_{CM}$ ) for a DAC differential pair configured for  $\pm 20$ -V and 0 to 40-V operation, respectively.

After being configured as a differential output, the DACx-y pair can be set for toggle operation by updating the DACx toggle registers as described in Section 8.4.1.

Imbalances between the two differential signals result in common-mode and amplitude errors. The device incorporates an offset register that enables the user to introduce a voltage offset to the DACy channel of the DACx-y differential pair to compensate for a DC offset error between the two channels. The offset compensation gives approximately a  $\pm 0.2\%$ FSR adjustment window. The differential DAC data register must be rewritten after an update to the offset register.



**Figure 8-2. Differential Bipolar Output (16-Bit):  $\pm 20$ -V Output Range**



**Figure 8-3. Differential Unipolar Output (16-Bit): 0-V to 40-V Output Range**

### 8.4.3 Power-Down Mode

The DACx1416 DAC output amplifiers and internal reference power-down status can be individually configured and monitored through the PWDWN registers. Setting a DAC channel in power-down mode disables the output amplifier and clamps the output pin to ground through an internal 10-k $\Omega$  resistor.

The DAC data registers are not cleared when the DAC goes into power-down which makes it possible to return to the same output voltage upon return to normal operation. The DAC data registers can also be updated while in power-down mode.

After a power-on or reset event all the DAC channels and the internal reference are in power-down mode. The entire device can be configured into power-down or active modes through the DEV-PWDWN bit.

## 8.5 Programming

The DACx1416 family of devices is controlled through a flexible four-wire serial interface that is compatible with SPI type interfaces used on many microcontrollers and DSP controllers. The interface provides access to the DACx1416 registers and can be configured to daisy-chain multiple devices for write operations. The DACx1416 incorporates an optional error checking mode to validate SPI data communication integrity in noisy environments.

### 8.5.1 Stand-Alone Operation

A serial interface access cycle is initiated by asserting the  $\overline{CS}$  pin low. The serial clock SCLK can be a continuous or gated clock. SDI data are clocked on SCLK falling edges. A regular serial interface access cycle is 24 bits long with error checking disabled and 32 bits long with error checking enabled, thus the  $\overline{CS}$  pin must stay low for at least 24 or 32 SCLK falling edges. The access cycle ends when the  $\overline{CS}$  pin is de-asserted high. If the access cycle contains less than the minimum clock edges, the communication is ignored. If the access cycle contains more than the minimum clock edges, only the first 24 or 32 bits are used by the device. When  $\overline{CS}$  is high, the SCLK and SDI signals are blocked and the SDO is in a Hi-Z state.

In an error checking disabled access cycle (24-bits long) the first byte input to SDI is the instruction cycle which identifies the request as a read or write command and the 6-bit address to be accessed. The last 16 bits in the cycle form the data cycle.

**Table 8-2. Serial Interface Access Cycle**

BIT	FIELD	DESCRIPTION
23	RW	Identifies the communication as a read or write command to the address register. R/W = 0 sets a write operation. R/W = 1 sets a read operation.
22	x	Don't care bit.
21-16	A[5:0]	Register address. Specifies the register to be accessed during the read or write operation.
15-0	DI[15:0]	Data cycle bits. If a write command, the data cycle bits are the values to be written to the register with address A[5:0]. If a read command, the data cycle bits are don't care values.

Read operations require that the SDO pin is first enabled by setting the SDO-EN bit. A read operation is initiated by issuing a read command access cycle. After the read command, a second access cycle must be issued to get the requested data. Data are clocked out on SDO pin either on the falling edge or rising edge of SCLK according to the FSDO bit.

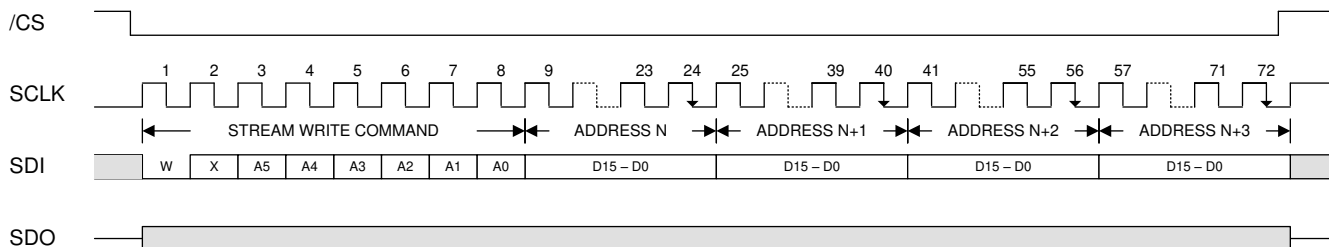
**Table 8-3. SDO Output Access Cycle**

BIT	FIELD	DESCRIPTION
23	RW	Echo RW from previous access cycle.
22	x	Echo bit 22 from previous access cycle.
21-16	A[5:0]	Echo address from previous access cycle.
15-0	DO[15:0]	Readback data requested on previous access cycle.

### 8.5.1.1 Streaming Mode Operation

Since updating the sixteen channels data registers requires a large amount of data to be passed to the device, the device supports streaming mode. In streaming mode the DAC data registers can be written to the device without providing an instruction command for each data register. Streaming mode is enabled by setting the STR-EN bit. Once enabled the streaming operation is implemented by holding the  $\overline{CS}$  active and continuing to shift new data into the device.

The instruction cycle includes the starting address. The device starts writing to this address and automatically increments the address as long as  $\overline{CS}$  is asserted. If the last DAC data register address has been reached and  $\overline{CS}$  is still asserted, the data for this address is overwritten with the new data.

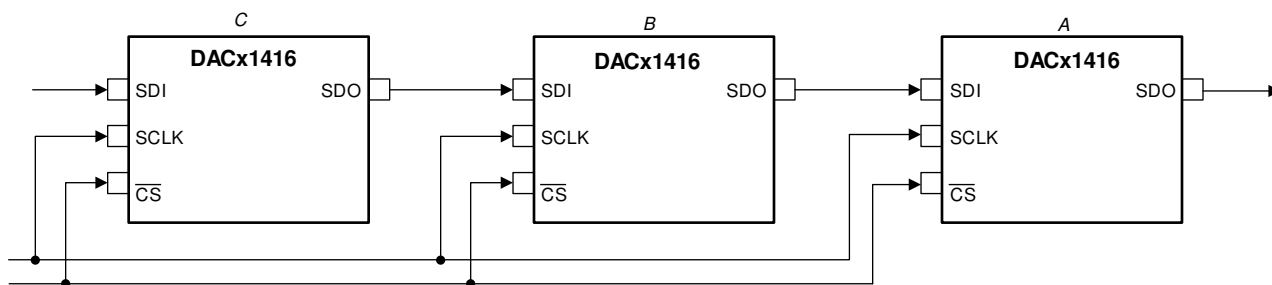


**Figure 8-4. Serial Interface Streaming Cycle**

### 8.5.2 Daisy-Chain Operation

For systems that contain more than one DACx1416 devices, the SDO pin can be used to daisy-chain them together. The SDO pin must be enabled by setting the SDO-EN bit before initiating the daisy-chain operation. Daisy-chain operation is useful in reducing the number of serial interface lines.

The first falling edge on the  $\overline{CS}$  pin starts the operation cycle. If more than 24 SCLK pulses are applied while the  $\overline{CS}$  pin is kept low, the data ripples out of the shift register and is clocked out on the SDO pin either on the falling edge or rising edge of SCLK according to the FSDO bit. By connecting the SDO output of the first device in the chain, a multiple-device interface is constructed. Each device in the system requires 24 clock pulses. As a result the total number of clock cycles must be equal to  $24 \times N$ , where N is the total number of DACx1416 devices in the daisy chain. When the serial transfer to all devices is complete the  $\overline{CS}$  signal is taken high. This action transfers the data from the SPI shift registers to the internal registers of each device in the daisy chain and prevents any further data from being clocked into the input shift register. Daisy-chain operation is not supported while in streaming mode.



**Figure 8-5. Daisy-Chain Layout**

### 8.5.3 Frame Error Checking

If the DACx1416 is used in a noisy environment, error checking can be used to check the integrity of SPI data communication between the device and the host processor. This feature is enabled by setting the CRC-EN bit.

The error checking scheme is based on the CRC-8-ATM (HEC) polynomial  $x^8 + x^2 + x + 1$  (that is, 100000111). When error checking is enabled, the serial interface access cycle width is 32 bits. The normal 24-bit SPI data is appended with an 8-bit CRC polynomial by the host processor before feeding it to the device. In all serial interface readback operations the CRC polynomial is output on the SDO pin as part of the 32-bit cycle.

**Table 8-4. Error Checking Serial Interface Access Cycle**

BIT	FIELD	DESCRIPTION
31	RW	Identifies the communication as a read or write command to the address register. R/W = 0 sets a write operation. R/W = 1 sets a read operation.
30	CRC-ERROR	Reserved bit. Set to zero.
29-24	A[5:0]	Register address. Specifies the register to be accessed during the read or write operation.
23-8	DI[15:0]	Data cycle bits. If a write command, the data cycle bits are the values to be written to the register with address A[5:0]. If a read command, the data cycle bits are don't care values.
7-0	CRC	8-bit CRC polynomial.

The DACx1416 decodes the 32-bit access cycle to compute the CRC remainder on  $\overline{CS}$  rising edges. If no error exists, the CRC remainder is zero and data are accepted by the device.

A write operation failing the CRC check causes the data to be ignored by the device. After the write command, a second access cycle can be issued to determine the error checking results (CRC-ERROR bit) on the SDO pin.

If there is a CRC error, the CRC-ALM bit of the status register is set to 1. The  $\overline{ALMOUT}$  pin can be configured to monitor a CRC error by setting the CRCALM-EN bit.

**Table 8-5. Write Operation Error Checking Cycle**

BIT	FIELD	DESCRIPTION
31	RW	Echo RW from previous access cycle (RW = 0).
30	CRC-ERROR	Returns a 1 when a CRC error is detected, 0 otherwise.
29-24	A[5:0]	Echo address from previous access cycle.
23-8	DO[15:0]	Echo data from previous access cycle.
7-0	CRC	Calculated CRC value of bits 31:8.

A read operation must be followed by a second access cycle to get the requested data on the SDO pin. The error check result (CRC-ERROR bit) from the read command is output on the SDO pin.

As in the case of a write operation failing the CRC check, the CRC-ALM bit of the status register is set to 1 and the ALMOUT pin, if configured for CRC alerts, is set low.

**Table 8-6. Read Operation Error Checking Cycle**

BIT	FIELD	DESCRIPTION
31	RW	Echo RW from previous access cycle (RW = 1).
30	CRC-ERROR	Returns a 1 when a CRC error is detected, 0 otherwise.
29-24	A[5:0]	Echo address from previous access cycle.
23-8	DO[15:0]	Readback data requested on previous access cycle.
7-0	CRC	Calculated CRC value of bits 31:8.

## 8.6 Register Maps

Table 8-7 lists the memory-mapped registers for the device. All register offset addresses not listed in Table 8-7 should be considered as reserved locations and the register contents should not be modified.

**Table 8-7. DACx1416 Registers**

Offset	Acronym	Register Name	Section
00h	NOP	NOP Register	<a href="#">Go</a>
01h	DEVICEID	Device ID Register	<a href="#">Go</a>
02h	STATUS	Status Register	<a href="#">Go</a>
03h	SPICONFIG	SPI Configuration Register	<a href="#">Go</a>
04h	GENCONFIG	General Configuration Register	<a href="#">Go</a>
05h	BRDCONFIG	Broadcast Configuration Register	<a href="#">Go</a>
06h	SYNCCONFIG	Sync Configuration Register	<a href="#">Go</a>
07h	TOGGCONFIG0	DAC[15:8] Toggle Configuration Register	<a href="#">Go</a>
08h	TOGGCONFIG1	DAC[7:0] Toggle Configuration Register	<a href="#">Go</a>
09h	DACPWDWN	DAC Power-Down Register	<a href="#">Go</a>
0Ah	DACRANGE0	DAC[15:12] Range Register	<a href="#">Go</a>
0Bh	DACRANGE1	DAC[11:8] Range Register	<a href="#">Go</a>
0Ch	DACRANGE2	DAC[7:4] Range Register	<a href="#">Go</a>
0Dh	DACRANGE3	DAC[3:0] Range Register	<a href="#">Go</a>
0Eh	TRIGGER	Trigger Register	<a href="#">Go</a>
0Fh	BRDCAST	Broadcast Data Register	<a href="#">Go</a>
10h	DAC0	DAC0 Data Register	<a href="#">Go</a>
11h	DAC1	DAC1 Data Register	<a href="#">Go</a>
12h	DAC2	DAC2 Data Register	<a href="#">Go</a>
13h	DAC3	DAC3 Data Register	<a href="#">Go</a>
14h	DAC4	DAC4 Data Register	<a href="#">Go</a>
15h	DAC5	DAC5 Data Register	<a href="#">Go</a>
16h	DAC6	DAC6 Data Register	<a href="#">Go</a>
17h	DAC7	DAC7 Data Register	<a href="#">Go</a>
18h	DAC8	DAC8 Data Register	<a href="#">Go</a>
19h	DAC9	DAC9 Data Register	<a href="#">Go</a>
1Ah	DAC10	DAC10 Data Register	<a href="#">Go</a>
1Bh	DAC11	DAC11 Data Register	<a href="#">Go</a>
1Ch	DAC12	DAC12 Data Register	<a href="#">Go</a>
1Dh	DAC13	DAC13 Data Register	<a href="#">Go</a>
1Eh	DAC14	DAC14 Data Register	<a href="#">Go</a>
1Fh	DAC15	DAC15 Data Register	<a href="#">Go</a>
20h	OFFSET0	DAC[14-15;12-13] Differential Offset Register	<a href="#">Go</a>
21h	OFFSET1	DAC[10-11;8-9] Differential Offset Register	<a href="#">Go</a>
22h	OFFSET2	DAC[6-7;4-5] Differential Offset Register	<a href="#">Go</a>
23h	OFFSET3	DAC[2-3;0-1] Differential Offset Register	<a href="#">Go</a>

Complex bit access types are encoded to fit into small table cells. [Table 8-8](#) shows the codes that are used for access types in this section.

**Table 8-8. Access Type Codes**

Access Type	Code	Description
Read Type		
R	R	Read
Write Type		
W	W	Write
Reset or Default Value		
-n		Value after reset or the default value
Register Array Variables		
i,j,k,l,m,n		When these variables are used in a register name, an offset, or an address, they refer to the value of a register array where the register is part of a group of repeating registers. The register groups form a hierarchical structure and the array is represented with a formula.
y		When this variable is used in a register name, an offset, or an address it refers to the value of a register array.

### 8.6.1 NOP Register (Offset = 00h) [reset = 0000h]

NOP is shown in [Figure 8-6](#) and described in [Table 8-9](#).

Return to [Summary Table](#).

**Figure 8-6. NOP Register**

15	14	13	12	11	10	9	8	7	6	5	4	3	2	1	0
NOP															
W-0h															

**Table 8-9. NOP Register Field Descriptions**

Bit	Field	Type	Reset	Description
15-0	NOP	W	0h	No operation. Write 0000h for proper no-operation command.

### 8.6.2 DEVICEID Register (Offset = 01h) [reset = ----h]

DEVICEID is shown in [Figure 8-7](#) and described in [Table 8-10](#).

Return to [Summary Table](#).

**Figure 8-7. DEVICEID Register**

15	14	13	12	11	10	9	8
DEVICEID							
R----h							
7	6	5	4	3	2	1	0
DEVICEID						VERSIONID	
R----h						R-0h	

**Table 8-10. DEVICEID Register Field Descriptions**

Bit	Field	Type	Reset	Description
15-2	DEVICEID	R	---h	Device ID DAC81416: 29Ch DAC71416: 28Ch DAC61416: 24Ch
1-0	VERSIONID	R	0h	Version ID. Subject to change.



### 8.6.3 STATUS Register (Offset = 02h) [reset = 0000h]

STATUS is shown in [Figure 8-8](#) and described in [Table 8-11](#).

Return to [Summary Table](#).

**Figure 8-8. STATUS Register**

15	14	13	12	11	10	9	8
RESERVED							
R-0h							
7	6	5	4	3	2	1	0
RESERVED				CRC-ALM		DAC-BUSY	TEMP-ALM
R-0h				R-0h		R-0h	R-0h

**Table 8-11. STATUS Register Field Descriptions**

Bit	Field	Type	Reset	Description
15-3	RESERVED	R	0h	This bit is reserved.
2	CRC-ALM	R	0h	CRC-ALM = 1 indicates a CRC error.
1	DAC-BUSY	R	0h	DAC-BUSY = 1 indicates DAC registers are not ready for updates.
0	TEMP-ALM	R	0h	TEMP-ALM = 1 indicates die temperature is over +140°C. A thermal alarm event forces the DAC outputs to go into power-down mode.

### 8.6.4 SPICONFIG Register (Offset = 03h) [reset = 0AA4h]

SPICONFIG is shown in [Figure 8-9](#) and described in [Table 8-12](#).

Return to [Summary Table](#).

**Figure 8-9. SPICONFIG Register**

15	14	13	12	11	10	9	8
RESERVED				TEMPALM-EN	DACBUSY-EN	CRCALM-EN	RESERVED
R-0h				R/W-1h	R/W-0h	R/W-1h	R-0h
7	6	5	4	3	2	1	0
RESERVED	SOFTTOGGLE-EN	DEV-PWDWN	CRC-EN	STR-EN	SDO-EN	FSDO	RESERVED
R-1h	R/W-0h	R/W-1h	R/W-0h	R/W-0h	R/W-1h	R/W-0h	R-0h

**Table 8-12. SPICONFIG Register Field Descriptions**

Bit	Field	Type	Reset	Description
15-12	RESERVED	R	0h	This bit is reserved.
11	TEMPALM-EN	R/W	1h	When set to 1 a thermal alarm triggers the $\overline{\text{ALMOUT}}$ pin.
10	DACBUSY-EN	R/W	0h	When set to 1 the $\overline{\text{ALMOUT}}$ pin is set between DAC output updates. Contrary to other alarm events, this alarm resets automatically.
9	CRCALM-EN	R/W	1h	When set to 1 a CRC error triggers the $\overline{\text{ALMOUT}}$ pin.
8	RESERVED	R	0h	This bit is reserved.
7	RESERVED	R	1h	This bit is reserved.
6	SOFTTOGGLE-EN	R/W	0h	When set to 1 enables soft toggle operation.
5	DEV-PWDWN	R/W	1h	DEV-PWDWN = 1 sets the device in power-down mode DEV-PWDWN = 0 sets the device in active mode
4	CRC-EN	R/W	0h	When set to 1 frame error checking is enabled.
3	STR-EN	R/W	0h	When set to 1 streaming mode operation is enabled.
2	SDO-EN	R/W	1h	When set to 1 the SDO pin is operational.
1	FSDO	R/W	0h	Fast SDO bit (half-cycle speedup). When 0, SDO updates during SCLK rising edges. When 1, SDO updates during SCLK falling edges.
0	RESERVED	R	0h	This bit is reserved.

### 8.6.5 GENCONFIG Register (Offset = 04h) [reset = 7F00h]

GENCONFIG is shown in [Figure 8-10](#) and described in [Table 8-13](#).

Return to [Summary Table](#).

**Figure 8-10. GENCONFIG Register**

15	14	13	12	11	10	9	8
RESERVED	REF-PWDWN	RESERVED					
R-0h	R/W-1h	R-1h					
7	6	5	4	3	2	1	0
DAC-14-15-DIFF-EN	DAC-12-13-DIFF-EN	DAC-10-11-DIFF-EN	DAC-8-9-DIFF-EN	DAC-6-7-DIFF-EN	DAC-4-5-DIFF-EN	DAC-2-3-DIFF-EN	DAC-0-1-DIFF-EN
R/W-0h	R/W-0h	R/W-0h	R/W-0h	R/W-0h	R/W-0h	R/W-0h	R/W-0h

**Table 8-13. GENCONFIG Register Field Descriptions**

Bit	Field	Type	Reset	Description
15	RESERVED	R	0h	This bit is reserved.
14	REF-PWDWN	R/W	1h	REF-PWDWN = 1 powers down the internal reference REF-PWDWN = 0 activates the internal reference
13-8	RESERVED	R	1h	This bit is reserved.
7	DAC-14-15-DIFF-EN	R/W	0h	When set to 1 the corresponding DAC pair is set to operate in differential mode. The DAC data registers must be rewritten after enabling or disabling differential operation.
6	DAC-12-13-DIFF-EN	R/W	0h	
5	DAC-10-11-DIFF-EN	R/W	0h	
4	DAC-8-9-DIFF-EN	R/W	0h	
3	DAC-6-7-DIFF-EN	R/W	0h	
2	DAC-4-5-DIFF-EN	R/W	0h	
1	DAC-2-3-DIFF-EN	R/W	0h	
0	DAC-0-1-DIFF-EN	R/W	0h	

### 8.6.6 BRDCONFIG Register (Offset = 05h) [reset = FFFFh]

BRDCONFIG is shown in [Figure 8-11](#) and described in [Table 8-14](#).

Return to [Summary Table](#).

**Figure 8-11. BRDCONFIG Register**

15		14		13		12		11		10		9		8	
DAC15-BRDCAST-EN		DAC14-BRDCAST-EN		DAC13-BRDCAST-EN		DAC12-BRDCAST-EN		DAC11-BRDCAST-EN		DAC10-BRDCAST-EN		DAC9-BRDCAST-EN		DAC8-BRDCAST-EN	
R/W-1h		R/W-1h		R/W-1h		R/W-1h		R/W-1h		R/W-1h		R/W-1h		R/W-1h	
7		6		5		4		3		2		1		0	
DAC7-BRDCAST-EN		DAC6-BRDCAST-EN		DAC5-BRDCAST-EN		DAC4-BRDCAST-EN		DAC3-BRDCAST-EN		DAC2-BRDCAST-EN		DAC1-BRDCAST-EN		DAC0-BRDCAST-EN	
R/W-1h		R/W-1h		R/W-1h		R/W-1h		R/W-1h		R/W-1h		R/W-1h		R/W-1h	

**Table 8-14. BRDCONFIG Register Field Descriptions**

Bit	Field	Type	Reset	Description
15	DAC15-BRDCAST-EN	R/W	1h	When set to 1 the corresponding DAC is set to update its output to the value set in the BRDCAST register. All DAC channels must be configured in single-ended mode for broadcast operation. If one or more outputs are configured in differential mode the broadcast mode is ignored.  When cleared to 0 the corresponding DAC output remains unaffected by a BRDCAST command.
14	DAC14-BRDCAST-EN	R/W	1h	
13	DAC13-BRDCAST-EN	R/W	1h	
12	DAC12-BRDCAST-EN	R/W	1h	
11	DAC11-BRDCAST-EN	R/W	1h	
10	DAC10-BRDCAST-EN	R/W	1h	
9	DAC9-BRDCAST-EN	R/W	1h	
8	DAC8-BRDCAST-EN	R/W	1h	
7	DAC7-BRDCAST-EN	R/W	1h	
6	DAC6-BRDCAST-EN	R/W	1h	
5	DAC5-BRDCAST-EN	R/W	1h	
4	DAC4-BRDCAST-EN	R/W	1h	
3	DAC3-BRDCAST-EN	R/W	1h	
2	DAC2-BRDCAST-EN	R/W	1h	
1	DAC1-BRDCAST-EN	R/W	1h	
0	DAC0-BRDCAST-EN	R/W	1h	

### 8.6.7 SYNCCONFIG Register (Offset = 06h) [reset = 0000h]

SYNCCONFIG is shown in [Figure 8-12](#) and described in [Table 8-15](#).

Return to [Summary Table](#).

**Figure 8-12. SYNCCONFIG Register**

15		14		13		12		11		10		9		8	
DAC15-SYNC-EN	DAC14-SYNC-EN	DAC13-SYNC-EN	DAC12-SYNC-EN	DAC11-SYNC-EN	DAC10-SYNC-EN	DAC9-SYNC-EN	DAC8-SYNC-EN	DAC7-SYNC-EN	DAC6-SYNC-EN	DAC5-SYNC-EN	DAC4-SYNC-EN	DAC3-SYNC-EN	DAC2-SYNC-EN	DAC1-SYNC-EN	DAC0-SYNC-EN
R/W-0h		R/W-0h		R/W-0h		R/W-0h		R/W-0h		R/W-0h		R/W-0h		R/W-0h	
7		6		5		4		3		2		1		0	
DAC7-SYNC-EN	DAC6-SYNC-EN	DAC5-SYNC-EN	DAC4-SYNC-EN	DAC3-SYNC-EN	DAC2-SYNC-EN	DAC1-SYNC-EN	DAC0-SYNC-EN	DAC7-SYNC-EN	DAC6-SYNC-EN	DAC5-SYNC-EN	DAC4-SYNC-EN	DAC3-SYNC-EN	DAC2-SYNC-EN	DAC1-SYNC-EN	DAC0-SYNC-EN
R/W-0h		R/W-0h		R/W-0h		R/W-0h		R/W-0h		R/W-0h		R/W-0h		R/W-0h	

**Table 8-15. SYNCCONFIG Register Field Descriptions**

Bit	Field	Type	Reset	Description
15	DAC15-SYNC-EN	R/W	0h	When set to 1 the corresponding DAC output is set to update in response to an LDAC trigger (synchronous mode). When cleared to 0 the corresponding DAC output is set to update immediately (asynchronous mode).
14	DAC14-SYNC-EN	R/W	0h	
13	DAC13-SYNC-EN	R/W	0h	
12	DAC12-SYNC-EN	R/W	0h	
11	DAC11-SYNC-EN	R/W	0h	
10	DAC10-SYNC-EN	R/W	0h	
9	DAC9-SYNC-EN	R/W	0h	
8	DAC8-SYNC-EN	R/W	0h	
7	DAC7-SYNC-EN	R/W	0h	
6	DAC6-SYNC-EN	R/W	0h	
5	DAC5-SYNC-EN	R/W	0h	
4	DAC4-SYNC-EN	R/W	0h	
3	DAC3-SYNC-EN	R/W	0h	
2	DAC2-SYNC-EN	R/W	0h	
1	DAC1-SYNC-EN	R/W	0h	
0	DAC0-SYNC-EN	R/W	0h	

### 8.6.8 TOGGCONFIG0 Register (Offset = 07h) [reset = 0000h]

TOGGCONFIG0 is shown in [Figure 8-13](#) and described in [Table 8-16](#).

Return to [Summary Table](#).

**Figure 8-13. TOGGCONFIG0 Register**

15	14	13	12	11	10	9	8
DAC15-AB-TOGG-EN		DAC14-AB-TOGG-EN		DAC13-AB-TOGG-EN		DAC12-AB-TOGG-EN	
R/W-0h		R/W-0h		R/W-0h		R/W-0h	
7	6	5	4	3	2	1	0
DAC11-AB-TOGG-EN		DAC10-AB-TOGG-EN		DAC9-AB-TOGG-EN		DAC8-AB-TOGG-EN	
R/W-0h		R/W-0h		R/W-0h		R/W-0h	

**Table 8-16. TOGGCONFIG0 Register Field Descriptions**

Bit	Field	Type	Reset	Description
15-14	DAC15-AB-TOGG-EN	R/W	0h	Enables toggle mode operation and configures the toggle pin or soft toggle bit: 00 = Toggle mode disabled 01 = Toggle mode enabled: TOGGLE0 10 = Toggle mode enabled: TOGGLE1 11 = Toggle mode enabled: TOGGLE2
13-12	DAC14-AB-TOGG-EN	R/W	0h	
11-10	DAC13-AB-TOGG-EN	R/W	0h	
9-8	DAC12-AB-TOGG-EN	R/W	0h	
7-6	DAC11-AB-TOGG-EN	R/W	0h	
5-4	DAC10-AB-TOGG-EN	R/W	0h	
3-2	DAC9-AB-TOGG-EN	R/W	0h	
1-0	DAC8-AB-TOGG-EN	R/W	0h	

### 8.6.9 TOGGCONFIG1 Register (Offset = 08h) [reset = 0000h]

TOGGCONFIG1 is shown in [Figure 8-14](#) and described in [Table 8-17](#).

Return to [Summary Table](#).

**Figure 8-14. TOGGCONFIG1 Register**

15	14	13	12	11	10	9	8
DAC7-AB-TOGG-EN		DAC6-AB-TOGG-EN		DAC5-AB-TOGG-EN		DAC4-AB-TOGG-EN	
R/W-0h		R/W-0h		R/W-0h		R/W-0h	
7	6	5	4	3	2	1	0
DAC3-AB-TOGG-EN		DAC2-AB-TOGG-EN		DAC1-AB-TOGG-EN		DAC0-AB-TOGG-EN	
R/W-0h		R/W-0h		R/W-0h		R/W-0h	

**Table 8-17. TOGGCONFIG1 Register Field Descriptions**

Bit	Field	Type	Reset	Description
15-14	DAC7-AB-TOGG-EN	R/W	0h	Enables toggle mode operation and configures the toggle pin or soft toggle bit: 00 = Toggle mode disabled 01 = Toggle mode enabled: TOGGLE0 10 = Toggle mode enabled: TOGGLE1 11 = Toggle mode enabled: TOGGLE2
13-12	DAC6-AB-TOGG-EN	R/W	0h	
11-10	DAC5-AB-TOGG-EN	R/W	0h	
9-8	DAC4-AB-TOGG-EN	R/W	0h	
7-6	DAC3-AB-TOGG-EN	R/W	0h	
5-4	DAC2-AB-TOGG-EN	R/W	0h	
3-2	DAC1-AB-TOGG-EN	R/W	0h	
1-0	DAC0-AB-TOGG-EN	R/W	0h	

### 8.6.10 DACPWDWN Register (Offset = 09h) [reset = FFFFh]

DACPWDWN is shown in [Figure 8-15](#) and described in [Table 8-18](#).

Return to [Summary Table](#).

**Figure 8-15. DACPWDWN Register**

15	14	13	12	11	10	9	8
DAC15-PWDWN	DAC14-PWDWN	DAC13-PWDWN	DAC12-PWDWN	DAC11-PWDWN	DAC10-PWDWN	DAC9-PWDWN	DAC8-PWDWN
R/W-1h	R/W-1h	R/W-1h	R/W-1h	R/W-1h	R/W-1h	R/W-1h	R/W-1h
7	6	5	4	3	2	1	0
DAC7-PWDWN	DAC6-PWDWN	DAC5-PWDWN	DAC4-PWDWN	DAC3-PWDWN	DAC2-PWDWN	DAC1-PWDWN	DAC0-PWDWN
R/W-1h	R/W-1h	R/W-1h	R/W-1h	R/W-1h	R/W-1h	R/W-1h	R/W-1h

**Table 8-18. DACPWDWN Register Field Descriptions**

Bit	Field	Type	Reset	Description
15	DAC15-PWDWN	R/W	1h	When set to 1 the corresponding DAC is in power-down mode and its output is connected to GND through a 10-kΩ internal resistor.
14	DAC14-PWDWN	R/W	1h	
13	DAC13-PWDWN	R/W	1h	
12	DAC12-PWDWN	R/W	1h	
11	DAC11-PWDWN	R/W	1h	
10	DAC10-PWDWN	R/W	1h	
9	DAC9-PWDWN	R/W	1h	
8	DAC8-PWDWN	R/W	1h	
7	DAC7-PWDWN	R/W	1h	
6	DAC6-PWDWN	R/W	1h	
5	DAC5-PWDWN	R/W	1h	
4	DAC4-PWDWN	R/W	1h	
3	DAC3-PWDWN	R/W	1h	
2	DAC2-PWDWN	R/W	1h	
1	DAC1-PWDWN	R/W	1h	
0	DAC0-PWDWN	R/W	1h	



### 8.6.11 DACRANGEn Register (Offset = 0Ah - 0Dh) [reset = 0000h]

DACRANGEn is shown in [Figure 8-16](#) and described in [Table 8-19](#).

Return to [Summary Table](#).

**Figure 8-16. DACRANGEn Register**

15	14	13	12	11	10	9	8
DACa-RANGE[3:0]				DACb-RANGE[3:0]			
W-0h				W-0h			
7	6	5	4	3	2	1	0
DACc-RANGE[3:0]				DACd-RANGE[3:0]			
W-0h				W-0h			

**Table 8-19. DACRANGEn Register Field Descriptions**

Bit	Field	Type	Reset	Description
15-12	DACa-RANGE[3:0]	W	0h	Sets the output range for the corresponding DAC.
11-8	DACb-RANGE[3:0]	W	0h	0000 = 0 to 5 V
7-4	DACc-RANGE[3:0]	W	0h	0001 = 0 to 10 V
3-0	DACd-RANGE[3:0]	W	0h	0010 = 0 to 20 V
				0100 = 0 to 40 V
				1001 = -5 V to +5 V
				1010 = -10 V to +10 V
				1100 = -20 V to +20 V
				1110 = -2.5 V to +2.5 V
				All others: invalid
				The two outputs of a differential DAC pair must be configured to the same output range prior to setting them up as a differential pair. a: 15, 11, 7 or 3; b: 14, 10, 6 or 2; c: 13, 9, 5 or 1; d: 12, 8, 4 or 0

### 8.6.12 TRIGGER Register (Offset = 0Eh) [reset = 0000h]

TRIGGER is shown in [Figure 8-17](#) and described in [Table 8-20](#).

Return to [Summary Table](#).

**Figure 8-17. TRIGGER Register**

15	14	13	12	11	10	9	8
RESERVED							ALM-RESET
W-0h							W-0h
7	6	5	4	3	2	1	0
AB-TOG2	AB-TOG1	AB-TOG0	LDAC	SOFT-RESET[3:0]			
W-0h	W-0h	W-0h	W-0h	W-0h			

**Table 8-20. TRIGGER Register Field Descriptions**

Bit	Field	Type	Reset	Description
15-9	RESERVED	W	0h	This bit is reserved
8	ALM-RESET	W	0h	Set this bit to 1 to clear an alarm event. Not applicable for a DAC-BUSY alarm event.
7	AB-TOG2	W	0h	If soft toggle is enabled set, this bit controls the toggle between values for those DACs that have been set in toggle mode 2 in the TOGGCONFIG register. Set to 1 to update to Register B and clear to 0 for Register A.
6	AB-TOG1	W	0h	If soft toggle is enabled set, this bit controls the toggle between values for those DACs that have been set in toggle mode 1 in the TOGGCONFIG register. Set to 1 to updated to Register B and clear to 0 for Register A.
5	AB-TOG0	W	0h	If soft toggle is enabled set, this bit controls the toggle between values for those DACs that have been set in toggle mode 0 in the TOGGCONFIG register. Set to 1 to update to Register B and clear to 0 for Register A.
4	LDAC	W	0h	Set this bit to 1 to synchronously load those DACs who have been set in synchronous mode in the SYNCCONFIG register.
3-0	SOFT-RESET[3:0]	W	0h	When set to the reserved code 1010 resets the device to its default state.

### 8.6.13 BRDCAST Register (Offset = 0Fh) [reset = 0000h]

BRDCAST is shown in [Figure 8-18](#) and described in [Table 8-21](#).

Return to [Summary Table](#).

**Figure 8-18. BRDCAST Register**

15	14	13	12	11	10	9	8	7	6	5	4	3	2	1	0
BRDCAST-DATA[15:0]															
R/W-0h															

**Table 8-21. BRDCAST Register Field Descriptions**

Bit	Field	Type	Reset	Description
15-0	BRDCAST-DATA[15:0]	R/W	0h	<p>Writing to the BRDCAST register forces those DAC channels that have been set to broadcast in the BRDCONFIG register to update its data register data to the BRDCAST-DATA one.</p> <p>Data is MSB aligned in straight binary format and follows the format below:</p> <p>DAC81416: { DATA[15:0] }</p> <p>DAC71416: { DATA[13:0], x, x }</p> <p>DAC61416: { DATA[11:0], x, x, x, x }</p> <p>x – Don 't care bits</p>

### 8.6.14 DACn Register (Offset = 10h - 1Fh) [reset = 0000h]

DACn is shown in [Figure 8-19](#) and described in [Table 8-22](#).

Return to [Summary Table](#).

**Figure 8-19. DACn Register**

15	14	13	12	11	10	9	8	7	6	5	4	3	2	1	0
DACn-DATA[15:0]															
R/W-0h															

**Table 8-22. DACn Register Field Descriptions**

Bit	Field	Type	Reset	Description
15-0	DACn-DATA[15:0]	R/W	0h	<p>Stores the 16-, 14- or 12-bit data to be loaded to DACn in MSB aligned straight binary format. In differential DAC mode data is loaded into the lowest-valued DAC in the DAC pair (in pair DACxy, data is loaded into DACx and writes to DACy are ignored).</p> <p>Data follows the format below:</p> <p>DAC81416: { DATA[15:0] }</p> <p>DAC71416: { DATA[13:0], x, x }</p> <p>DAC61416: { DATA[11:0], x, x, x, x }</p> <p>x – Don 't care bits</p>

### 8.6.15 OFFSETn Register (Offset = 20h - 23h) [reset = 0000h]

OFFSETn is shown in [Figure 8-20](#) and described in [Table 8-23](#).

Return to [Summary Table](#).

**Figure 8-20. OFFSETn Register**

15	14	13	12	11	10	9	8
OFFSETab[7:0]							
R/W-0h							
7	6	5	4	3	2	1	0
OFFSETCd[7:0]							
R/W-0h							

**Table 8-23. OFFSETn Register Field Descriptions**

Bit	Field	Type	Reset	Description
15-8	OFFSETab[7:0]	R/W	0h	Provides offset adjustment to DACy in the differential DACx-y pair in two 's complement format. Data follows the format below: <ul style="list-style-type: none"> <li>• DAC81416:                             <ul style="list-style-type: none"> <li>– Format: { OFFSET[7:0] }</li> <li>– Range: -128 LSB to +127 LSB</li> </ul> </li> <li>• DAC71416:                             <ul style="list-style-type: none"> <li>– Format: { OFFSET[5:0], x, x }</li> <li>– Range: -32 LSB to +31 LSB</li> </ul> </li> <li>• DAC61416:                             <ul style="list-style-type: none"> <li>– Format: { OFFSET[3:0], x, x, x }</li> <li>– Range: -8 LSB to +7 LSB</li> </ul> </li> </ul> x – Don 't care bits The differential DAC data register must be rewritten after updating the offset register. ab: 14-15, 10-11, 6-7 or 2-3; cd: 12-13, 8-9, 4-5 or 0-1
7-0	OFFSETCd[7:0]	R/W	0h	

## 9 Application and Implementation

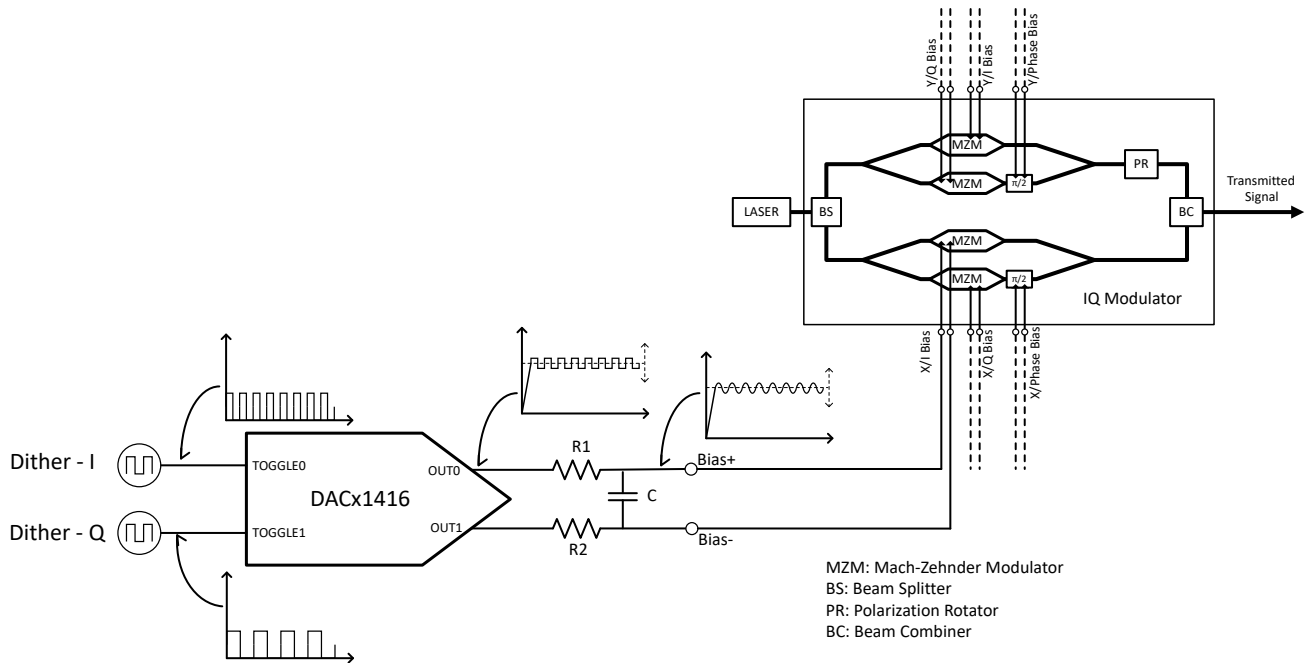
### Note

Information in the following applications sections is not part of the TI component specification, and TI does not warrant its accuracy or completeness. TI's customers are responsible for determining suitability of components for their purposes, as well as validating and testing their design implementation to confirm system functionality.

### 9.1 Application Information

One of the primary applications of the DACx1416 family is Mach Zehnder Modulator (MZM) biasing, employed in Optical Line Cards and Optical Modules. With high-voltage, high-current and differential output features, the DACx1416 family can be used for biasing both LiNbO<sub>3</sub> and InP type modulators. With the help of the toggle mode and multiple corresponding input pins, the required dither waveform for such applications can be generated without involving SPI programming. The small package size and integrated reference minimize the total footprint of such applications.

### 9.2 Typical Application



**Figure 9-1. Biasing a Mach Zehnder Modulator**

### 9.2.1 Design Requirements

Designing biasing circuits that are made to match both types of MZM technologies (LiNbO<sub>3</sub> and InP) requires high voltage and current ranges as shown in [Table 9-1](#). The Optical Internetworking Forum (OIF) recommends four differential IQ bias and two differential phase bias inputs, as shown in [Figure 9-1](#). This differential signaling scheme helps in minimizing the crosstalk and noise between channels, which may otherwise result in a complicated bias control algorithm. While an ideal dither tone should be a sine wave, generating a sine wave can be cumbersome in a largely digital circuit domain. A square wave is relatively easier to generate through digital circuits, and can also be used, provided that the bandwidth of this dither signal is lower than the low cutoff frequency of the receiver (that is, 100 kHz or 1 MHz as per OIF). Passive RC filters with cutoff frequency lower than 100 kHz can be used at the DAC output for LiNbO<sub>3</sub> modulators, which have very small bias current requirement. For InP modulators that are mainly used with optical modules, typically requiring a receiver low cutoff frequency of MHz, choose RC values so that the power dissipation across the resistors is small.

For smooth detection of the dither signal at the MZM output, use two orthogonal dither frequency sources for the *I* and *Q* arms. The amplitude of the dither waveform is typically 0.5% to 2.5% of the dc bias voltage, which is mainly governed by the design implementation.

**Table 9-1. Requirements of MZM Biasing Circuit**

PARAMETER	VALUE
DC range	Up to ±18 V
Dither amplitude	40 mV to 500 mV
Dither frequency	100 Hz to 100 kHz
Dither shape	Sine or square
Bias current	Up to 25 mA (for InP MZM)
Number of dither frequencies	2
Output type	Differential (6 pairs)

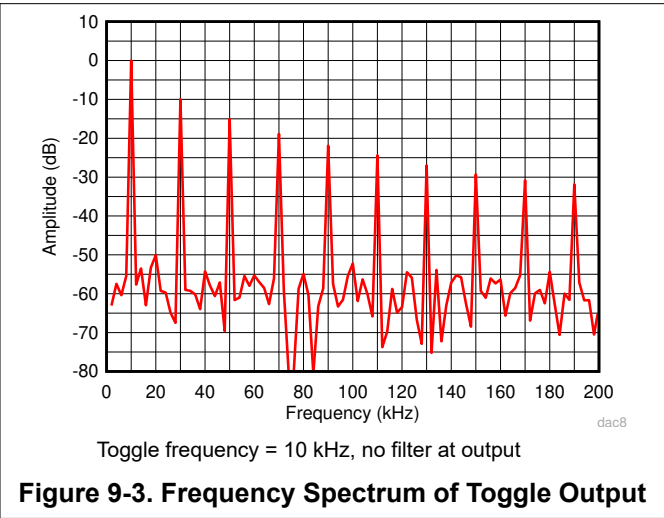
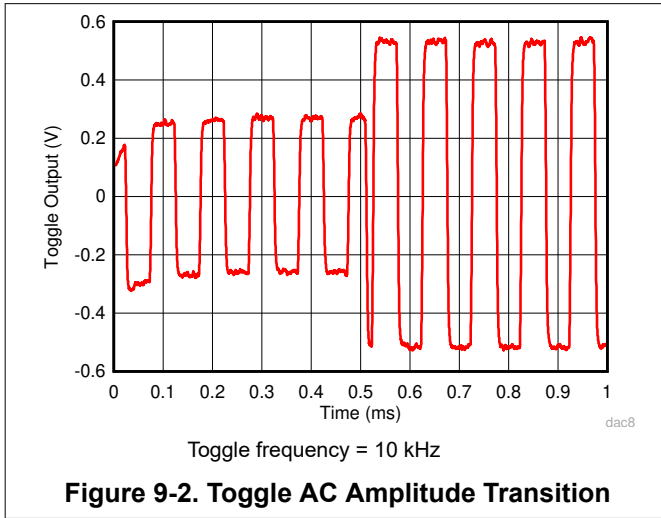
## 9.2.2 Detailed Design Procedure

Figure 9-1 provides the simplified circuit diagram for biasing a MZM for a *Dither-type Bias Control* circuit. As shown, this circuit requires four differential input pairs for IQ biasing, and two differential input pairs for phase biasing. To bias a  $\text{LiNbO}_3$  MZM, the voltage can be as high as  $\pm 18$  V, whereas the current requirement is of the order of few micro amperes. The low cutoff frequency of the receiver is typically 100 kHz, and hence, the bandwidth of the dither signals should be well below this frequency. Be aware that only the IQ bias inputs require the dither signal, and not the phase bias. The DACx1416 features a toggle mode wherein the outputs can be configured to provide a square wave imposed on a dc bias. This mode requires setting the HIGH and LOW codes for the square wave and the transition happens in sync with the selected toggle input pin. The pseudocode to achieve the dither output using the toggle function is provided below.

```
//SYNTAX: WRITE <REGISTER NAME>,<DATA>
//Power-on Device, Disable Soft-toggle
WRITE SPICONFIG,0x0A84
//Select Range for all 12 channels as  $\pm 10$ V
WRITE DACRANGE2, 0xAAAA
WRITE DACRANGE3, 0xAAAA
WRITE DACRANGE4, 0xAAAA
//Power-on DAC Channels 0 - 11
WRITE DACPWDWN,0xF000
//Write HIGH code to Register A of all IQ Bias Differential Pairs
WRITE DAC0,0xFFFF
WRITE DAC2,0xFFFF
WRITE DAC4,0xFFFF
WRITE DAC6,0xFFFF
//Write Data to Phase Bias Channels
WRITE DAC8,0xFFFF
WRITE DAC10,0xFFFF
//Enable Sync for All Differential Pairs
WRITE SYNCCONFIG,0x0FFF
//Enable Software LDAC
WRITE TRIGGER,0x0002
//Write LOW code to Register B of all IQ Bias Differential Pairs
WRITE DAC_DATA0,0xFFFF
WRITE DAC_DATA0,0xFFFF
WRITE DAC_DATA0,0xFFFF
WRITE DAC_DATA0,0xFFFF
//Turn Toggle Mode ON for All IQ Differential Pairs
//DAC11-10:Y/Phase Bias , DAC9-8:Y/I Bias - TOGG0, DAC7-6:Y/Q Bias - TOGG 1
//DAC5-4:Y/Phase Bias , DAC3-2:Y/I Bias - TOGG0, DAC1-0:Y/Q Bias - TOGG 1
WRITE TOGGCONFIG0,0x0005
WRITE TOGGCONFIG1,0xA05A
//Method to Modify the DC Value of Any IQ Differential Pair
//Turn Off Toggle Mode for that Channel (e.g. DAC0-1)
WRITE TOGGCONFIG1,0xA050
//Turn Off Sync for the Channel
WRITE SYNCCONFIG,0x0FFC
//Write HIGH code to Register A of the Channel Pair
WRITE DAC0,0xFFFF
//Turn On Sync for the Channel Pair
WRITE SYNCCONFIG,0x0FFF
//Turn On Toggle for the Channel Pair
WRITE TOGGCONFIG1,0xA05A
```

The dither frequencies can be set at 1 kHz and 2 kHz so that a single-pole RC low-pass filter can provide sufficient attenuation at 100 kHz. For example, when  $R1 = R2 = 10$  k $\Omega$  and  $C = 0.01$   $\mu$ F, an attenuation of approximately 40 dB is obtained at 100 kHz.

### 9.2.3 Application Curves





## 10 Power Supply Recommendations

The DACx1416 require five power supply inputs: VIO, VDD, VAA, VCC and VSS. VDD and VAA should be at same level. Assuming VIO and VDD/VAA to be different, there are four separate power-supply sources required.

Place a 0.1- $\mu$ F ceramic capacitor close to each power-supply pin. Be aware that VCC and VSS have two pins each. In addition, a 4.7- $\mu$ F or 10- $\mu$ F bulk capacitor is recommended for each power supply; tantalum or aluminum types can be chosen for the bulk capacitors.

There is no sequencing requirement for the power supplies. As the DAC output range is configurable, make sure that the power-supplies have enough headroom to achieve linearity at codes close to the power supply rails. When sourcing or sinking current from or to the DAC output, the heat dissipation must be considered. For example, a typical application of MZM bias with 25-mA load current from or to 12 channels with 2.5-V power-supply headroom can create a power dissipation across the DAC of  $(12 \times 2.5 \times 25 \text{ mA}) = 0.75 \text{ W}$ . The thermal design to dissipate the power in this example may involve inclusion of heat sinks in order to avoid thermal shutdown of the device.

## 11 Layout

### 11.1 Layout Guidelines

The pin configuration of the DACx1416 has been designed in such a way that the analog, digital, and power pins are spatially separated from each other, which makes the PCB layout simple. An example layout is shown in [Figure 11-1](#). As evident, every power supply pin has a 0.1- $\mu$ F capacitor close to the pin. Make sure to lay out the analog and digital signals away from each other, or on different PCB layers. Make sure to provide an unbroken reference plane (either ground or VIO) for the digital signals. The higher frequency signals, such as SCLK and SDI, must have appropriate impedance termination in order to address signal integrity.

### 11.2 Layout Example

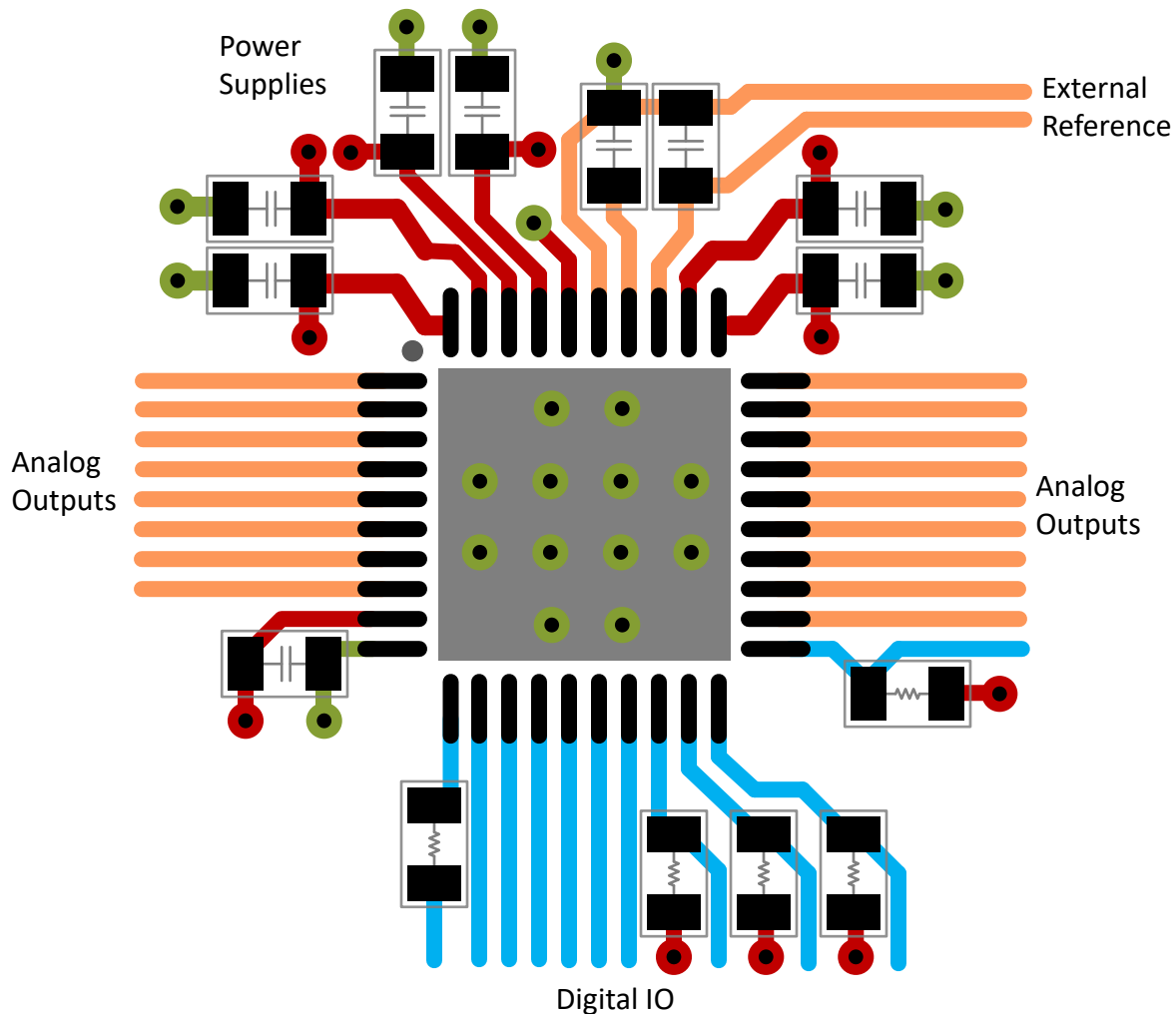


Figure 11-1. Example Layout

## 12 Device and Documentation Support

### 12.1 Device Support

#### 12.1.1 Development Support

For development support, see the following: [DAC81416 Evaluation Module](#)

### 12.2 Documentation Support

#### 12.2.1 Related Documentation

For related documentation see the following:

- Texas Instruments, [DAC81416EVM User's Guide](#)
- Texas Instruments, [DACx1416 Delivers Optimized Solution to Mach Zehnder Modulator Biasing application note](#)
- Texas Instruments, [Programmable Voltage Output With Sense Connections Circuit application note](#)

### 12.3 Receiving Notification of Documentation Updates

To receive notification of documentation updates, navigate to the device product folder on [ti.com](#). Click on *Subscribe to updates* to register and receive a weekly digest of any product information that has changed. For change details, review the revision history included in any revised document.

### 12.4 Support Resources

[TI E2E™ support forums](#) are an engineer's go-to source for fast, verified answers and design help — straight from the experts. Search existing answers or ask your own question to get the quick design help you need.

Linked content is provided "AS IS" by the respective contributors. They do not constitute TI specifications and do not necessarily reflect TI's views; see TI's [Terms of Use](#).

### 12.5 Trademarks

TI E2E™ is a trademark of Texas Instruments.

All trademarks are the property of their respective owners.

### 12.6 Electrostatic Discharge Caution



This integrated circuit can be damaged by ESD. Texas Instruments recommends that all integrated circuits be handled with appropriate precautions. Failure to observe proper handling and installation procedures can cause damage.

ESD damage can range from subtle performance degradation to complete device failure. Precision integrated circuits may be more susceptible to damage because very small parametric changes could cause the device not to meet its published specifications.

### 12.7 Glossary

[TI Glossary](#) This glossary lists and explains terms, acronyms, and definitions.

## 13 Mechanical, Packaging, and Orderable Information

The following pages include mechanical, packaging, and orderable information. This information is the most current data available for the designated devices. This data is subject to change without notice and revision of this document. For browser-based versions of this data sheet, refer to the left-hand navigation.

**PACKAGING INFORMATION**

Orderable Device	Status (1)	Package Type	Package Drawing	Pins	Package Qty	Eco Plan (2)	Lead finish/ Ball material (6)	MSL Peak Temp (3)	Op Temp (°C)	Device Marking (4/5)	Samples
DAC61416RHAR	ACTIVE	VQFN	RHA	40	2500	RoHS & Green	NIPDAUAG	Level-3-260C-168 HR	-40 to 125	DAC61416	<a href="#">Samples</a>
DAC61416RHAT	ACTIVE	VQFN	RHA	40	250	RoHS & Green	NIPDAUAG	Level-3-260C-168 HR	-40 to 125	DAC61416	<a href="#">Samples</a>
DAC71416RHAR	ACTIVE	VQFN	RHA	40	2500	RoHS & Green	NIPDAUAG	Level-3-260C-168 HR	-40 to 125	DAC71416	<a href="#">Samples</a>
DAC71416RHAT	ACTIVE	VQFN	RHA	40	250	RoHS & Green	NIPDAUAG	Level-3-260C-168 HR	-40 to 125	DAC71416	<a href="#">Samples</a>
DAC81416RHAR	ACTIVE	VQFN	RHA	40	2500	RoHS & Green	NIPDAUAG	Level-3-260C-168 HR	-40 to 125	DAC81416	<a href="#">Samples</a>
DAC81416RHAT	ACTIVE	VQFN	RHA	40	250	RoHS & Green	NIPDAUAG	Level-3-260C-168 HR	-40 to 125	DAC81416	<a href="#">Samples</a>

(1) The marketing status values are defined as follows:

**ACTIVE:** Product device recommended for new designs.

**LIFEBUY:** TI has announced that the device will be discontinued, and a lifetime-buy period is in effect.

**NRND:** Not recommended for new designs. Device is in production to support existing customers, but TI does not recommend using this part in a new design.

**PREVIEW:** Device has been announced but is not in production. Samples may or may not be available.

**OBSOLETE:** TI has discontinued the production of the device.

(2) **RoHS:** TI defines "RoHS" to mean semiconductor products that are compliant with the current EU RoHS requirements for all 10 RoHS substances, including the requirement that RoHS substance do not exceed 0.1% by weight in homogeneous materials. Where designed to be soldered at high temperatures, "RoHS" products are suitable for use in specified lead-free processes. TI may reference these types of products as "Pb-Free".

**RoHS Exempt:** TI defines "RoHS Exempt" to mean products that contain lead but are compliant with EU RoHS pursuant to a specific EU RoHS exemption.

**Green:** TI defines "Green" to mean the content of Chlorine (Cl) and Bromine (Br) based flame retardants meet JS709B low halogen requirements of <=1000ppm threshold. Antimony trioxide based flame retardants must also meet the <=1000ppm threshold requirement.

(3) MSL, Peak Temp. - The Moisture Sensitivity Level rating according to the JEDEC industry standard classifications, and peak solder temperature.

(4) There may be additional marking, which relates to the logo, the lot trace code information, or the environmental category on the device.

(5) Multiple Device Markings will be inside parentheses. Only one Device Marking contained in parentheses and separated by a "~" will appear on a device. If a line is indented then it is a continuation of the previous line and the two combined represent the entire Device Marking for that device.

(6) Lead finish/Ball material - Orderable Devices may have multiple material finish options. Finish options are separated by a vertical ruled line. Lead finish/Ball material values may wrap to two lines if the finish value exceeds the maximum column width.

**Important Information and Disclaimer:** The information provided on this page represents TI's knowledge and belief as of the date that it is provided. TI bases its knowledge and belief on information provided by third parties, and makes no representation or warranty as to the accuracy of such information. Efforts are underway to better integrate information from third parties. TI has taken and continues to take reasonable steps to provide representative and accurate information but may not have conducted destructive testing or chemical analysis on incoming materials and chemicals. TI and TI suppliers consider certain information to be proprietary, and thus CAS numbers and other limited information may not be available for release.

In no event shall TI's liability arising out of such information exceed the total purchase price of the TI part(s) at issue in this document sold by TI to Customer on an annual basis.

**TAPE AND REEL INFORMATION**

**QUADRANT ASSIGNMENTS FOR PIN 1 ORIENTATION IN TAPE**


\*All dimensions are nominal

Device	Package Type	Package Drawing	Pins	SPQ	Reel Diameter (mm)	Reel Width W1 (mm)	A0 (mm)	B0 (mm)	K0 (mm)	P1 (mm)	W (mm)	Pin1 Quadrant
DAC61416RHAR	VQFN	RHA	40	2500	330.0	16.4	6.3	6.3	1.1	12.0	16.0	Q1
DAC61416RHAT	VQFN	RHA	40	250	180.0	16.4	6.3	6.3	1.1	12.0	16.0	Q1
DAC71416RHAR	VQFN	RHA	40	2500	330.0	16.4	6.3	6.3	1.1	12.0	16.0	Q1
DAC71416RHAT	VQFN	RHA	40	250	180.0	16.4	6.3	6.3	1.1	12.0	16.0	Q1
DAC81416RHAR	VQFN	RHA	40	2500	330.0	16.4	6.3	6.3	1.1	12.0	16.0	Q1
DAC81416RHAT	VQFN	RHA	40	250	180.0	16.4	6.3	6.3	1.1	12.0	16.0	Q1

**TAPE AND REEL BOX DIMENSIONS**


\*All dimensions are nominal

Device	Package Type	Package Drawing	Pins	SPQ	Length (mm)	Width (mm)	Height (mm)
DAC61416RHAR	VQFN	RHA	40	2500	367.0	367.0	38.0
DAC61416RHAT	VQFN	RHA	40	250	213.0	191.0	35.0
DAC71416RHAR	VQFN	RHA	40	2500	367.0	367.0	38.0
DAC71416RHAT	VQFN	RHA	40	250	213.0	191.0	35.0
DAC81416RHAR	VQFN	RHA	40	2500	367.0	367.0	38.0
DAC81416RHAT	VQFN	RHA	40	250	213.0	191.0	35.0

## GENERIC PACKAGE VIEW

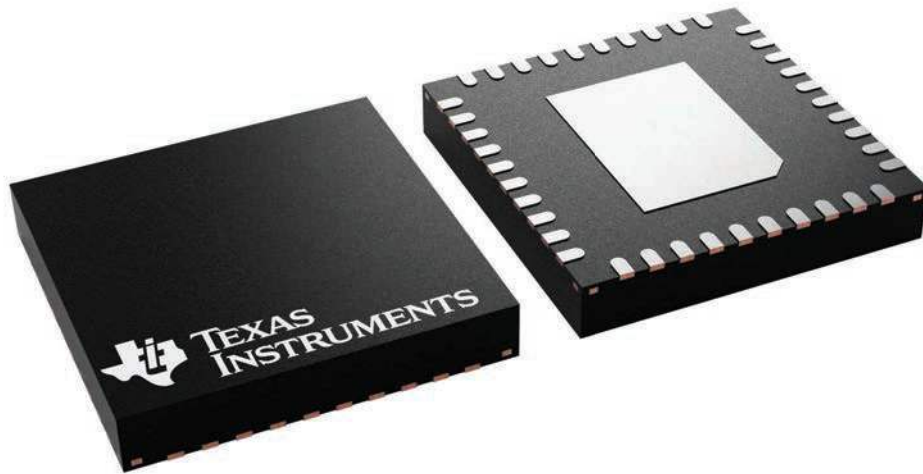
**RHA 40**

**VQFN - 1 mm max height**

6 x 6, 0.5 mm pitch

PLASTIC QUAD FLATPACK - NO LEAD

This image is a representation of the package family, actual package may vary.  
Refer to the product data sheet for package details.





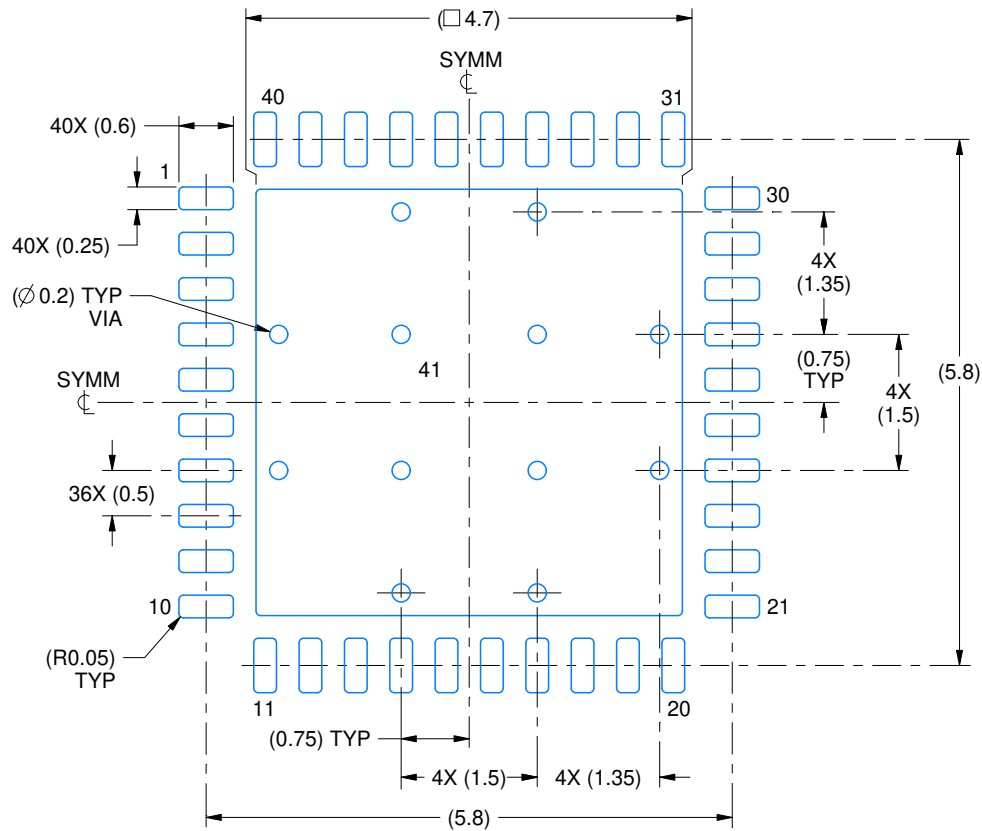


# EXAMPLE BOARD LAYOUT

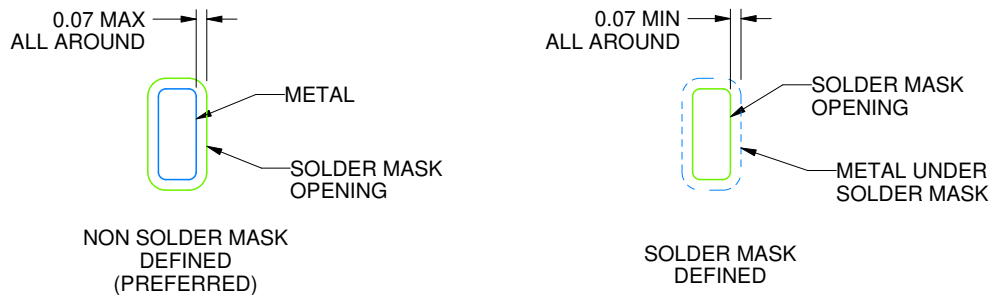
RHA0040C

VQFN - 1 mm max height

PLASTIC QUAD FLATPACK - NO LEAD



LAND PATTERN EXAMPLE  
SCALE:12X



SOLDER MASK DETAILS

4219053/B 03/2021

NOTES: (continued)

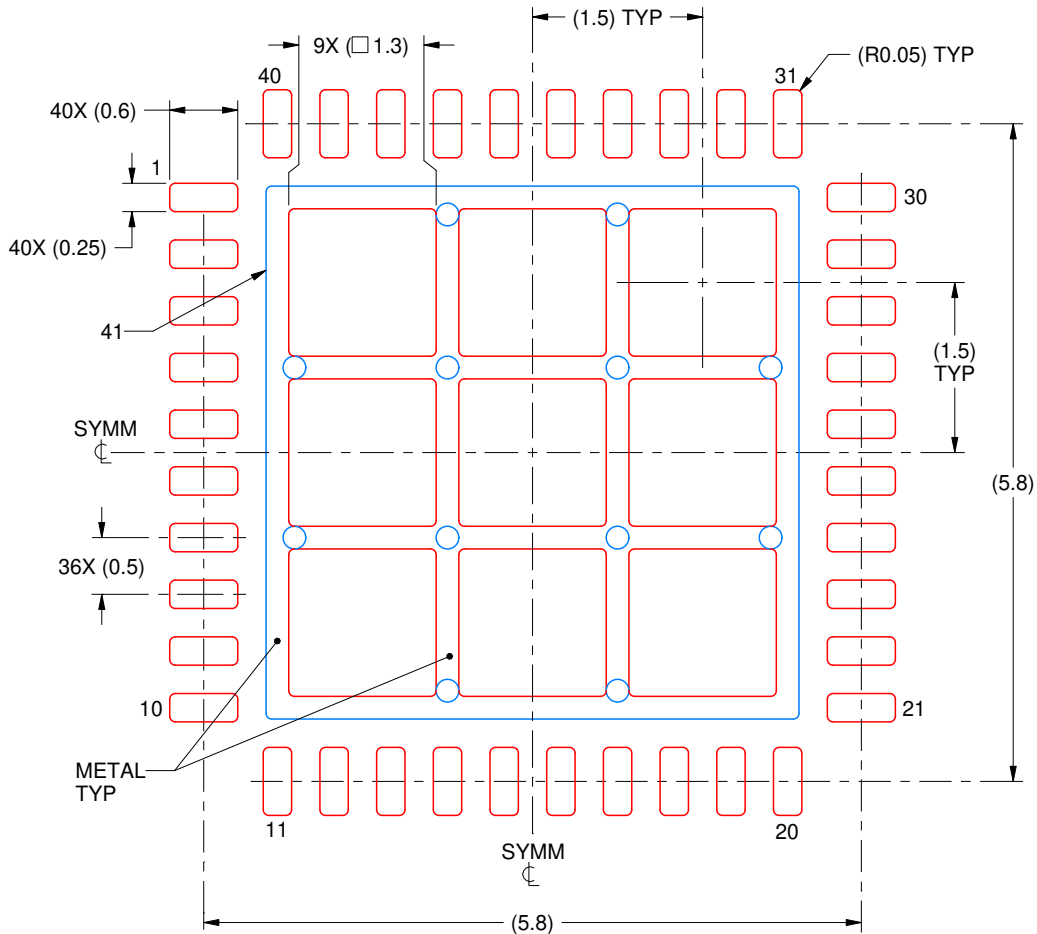
4. This package is designed to be soldered to a thermal pad on the board. For more information, see Texas Instruments literature number SLUA271 ([www.ti.com/lit/sluea271](http://www.ti.com/lit/sluea271)).
5. Vias are optional depending on application, refer to device data sheet. If any vias are implemented, refer to their locations shown on this view. It is recommended that vias under paste be filled, plugged or tented.

# EXAMPLE STENCIL DESIGN

RHA0040C

VQFN - 1 mm max height

PLASTIC QUAD FLATPACK - NO LEAD



**SOLDER PASTE EXAMPLE**  
BASED ON 0.125 mm THICK STENCIL

EXPOSED PAD 41:  
69% PRINTED SOLDER COVERAGE BY AREA  
SCALE:15X

4219053/B 03/2021

NOTES: (continued)

6. Laser cutting apertures with trapezoidal walls and rounded corners may offer better paste release. IPC-7525 may have alternate design recommendations.

## IMPORTANT NOTICE AND DISCLAIMER

TI PROVIDES TECHNICAL AND RELIABILITY DATA (INCLUDING DATASHEETS), DESIGN RESOURCES (INCLUDING REFERENCE DESIGNS), APPLICATION OR OTHER DESIGN ADVICE, WEB TOOLS, SAFETY INFORMATION, AND OTHER RESOURCES "AS IS" AND WITH ALL FAULTS, AND DISCLAIMS ALL WARRANTIES, EXPRESS AND IMPLIED, INCLUDING WITHOUT LIMITATION ANY IMPLIED WARRANTIES OF MERCHANTABILITY, FITNESS FOR A PARTICULAR PURPOSE OR NON-INFRINGEMENT OF THIRD PARTY INTELLECTUAL PROPERTY RIGHTS.

These resources are intended for skilled developers designing with TI products. You are solely responsible for (1) selecting the appropriate TI products for your application, (2) designing, validating and testing your application, and (3) ensuring your application meets applicable standards, and any other safety, security, or other requirements. These resources are subject to change without notice. TI grants you permission to use these resources only for development of an application that uses the TI products described in the resource. Other reproduction and display of these resources is prohibited. No license is granted to any other TI intellectual property right or to any third party intellectual property right. TI disclaims responsibility for, and you will fully indemnify TI and its representatives against, any claims, damages, costs, losses, and liabilities arising out of your use of these resources.

TI's products are provided subject to TI's Terms of Sale (<https://www.ti.com/legal/termsofsale.html>) or other applicable terms available either on [ti.com](https://www.ti.com) or provided in conjunction with such TI products. TI's provision of these resources does not expand or otherwise alter TI's applicable warranties or warranty disclaimers for TI products.

Mailing Address: Texas Instruments, Post Office Box 655303, Dallas, Texas 75265  
Copyright © 2021, Texas Instruments Incorporated