

### PLUG MATED TO VERTICAL RECEPTACLE MATED PROFILE

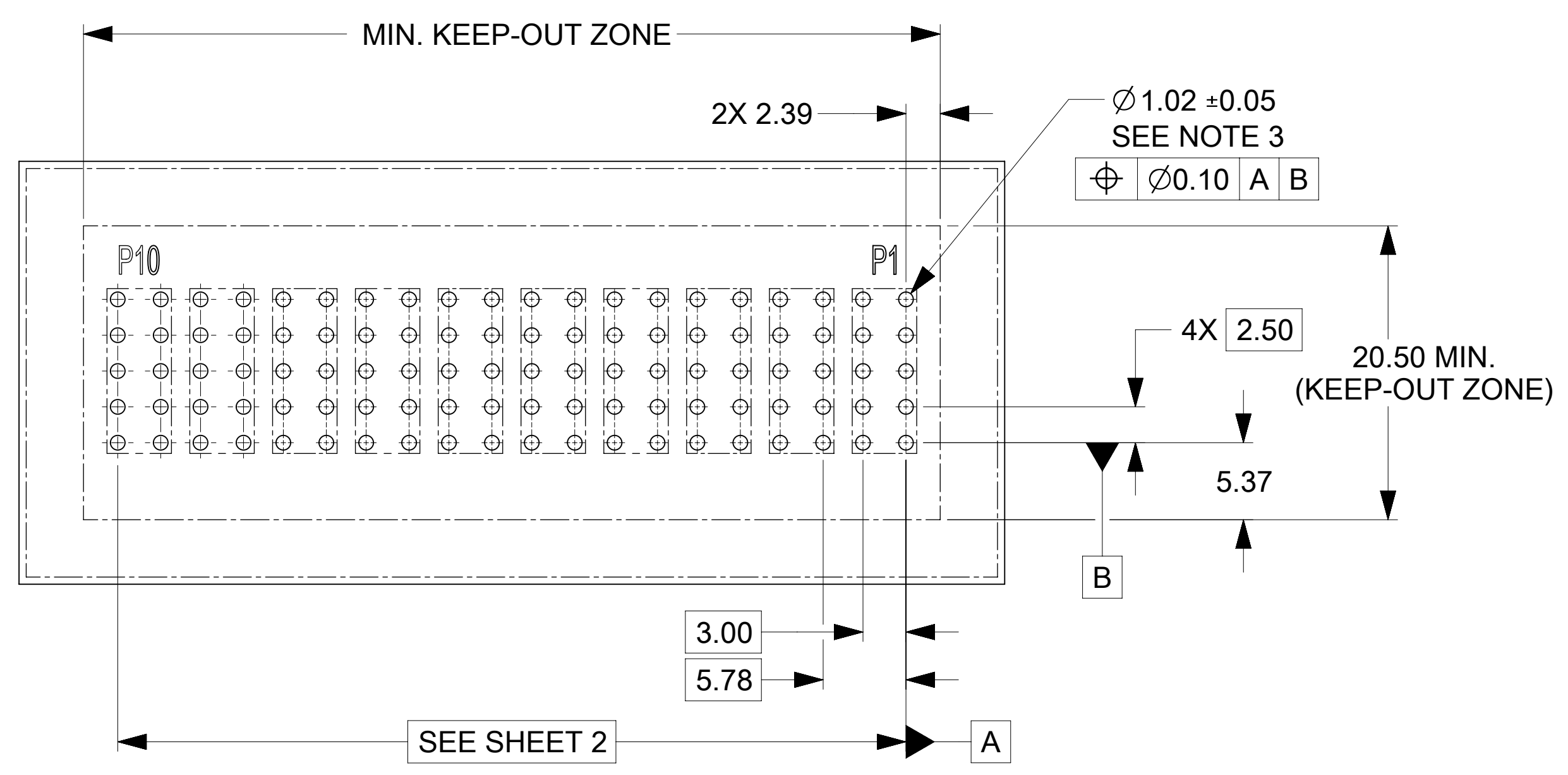

#### NOTES:

- MATERIAL:
  - HOUSINGS: LCP UL94, V-0, COLOR : BLACK
  - TERMINALS: HIGH CONDUCTIVITY COPPER ALLOY
  - PLATING: 1.27 µm (50 µin) NICKEL OVERALL WITH  
2.54 µm (100 µin) SELECTIVE TIN ON TAILS AND  
0.762 µm (30 µin) SELECTIVE GOLD ON CONTACT AREA
- PACKAGING: ASSEMBLIES TO BE TRAY PACKED PER PACKAGING SPEC: 2141140001-PK.
- PLATED THRU HOLE SIZE, REFER TO PRODUCT SPEC. FOR DETAILS.
- PRODUCT SPEC: 2141130000-PS.
- PRODUCT TO MEET RoHS REQUIREMENTS.
- VERTICAL ASSEMBLY MATES TO MOLEX PLUG 219562XXXX-SD, SEE DRAWING FOR DETAILS.
- TAIL DESIGN: COMPLIANT PIN.
- POWER TERMINALS ARE LUBRICATED.
- APPLICATION SPECIFICATION: 2141130000-AS (FOR COMPLIANT TAILS ONLY).

THIS DRAWING CONTAINS INFORMATION THAT IS PROPRIETARY TO MOLEX ELECTRONIC TECHNOLOGIES, LLC AND SHOULD NOT BE USED WITHOUT WRITTEN PERMISSION									
DIMENSION UNITS	SCALE	CURRENT REV DESC:							
mm	3:1								
GENERAL TOLERANCES (UNLESS SPECIFIED)									
ANGULAR TOL	± °								
4 PLACES	±	EC NO: 745288							
3 PLACES	±	DRWN: LZABJANOVSKI		2023/03/23					
2 PLACES	± 0.25	CHK'D: JAYK1		2023/04/10					
1 PLACE	± 0.3	APPR: JAYK1		2023/04/10					
0 PLACES	±	INITIAL REVISION:							
DRAFT WHERE APPLICABLE MUST REMAIN WITHIN DIMENSIONS		DRWN: LZABJANOVSKI		2022/03/30					
THIRD ANGLE PROJECTION		APPR: BPISZCZOR		2022/08/04					
D-DRAWING		SERIES		MATERIAL NUMBER		CUSTOMER		SHEET NUMBER	
D-SIZE		219563		SEE CHART				1 OF 2	

### RECOMMENDED PCB LAYOUT AND KEEP-OUT ZONE

PART NUMBER	CONFIGURATION	QUANTITY PER CARTON (DU)
219563-0031	1P	820

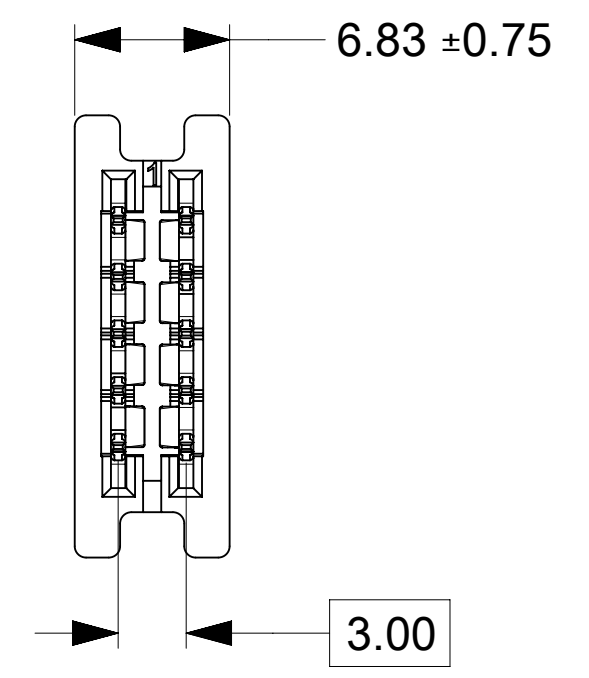

PART NUMBER	CONFIGURATION	QUANTITY PER CARTON (DU)
219563-0032	2P	440

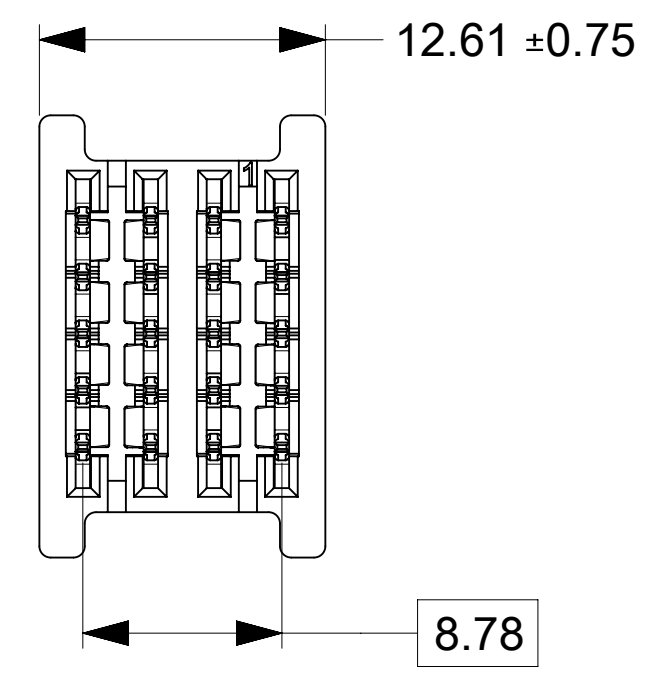

PART NUMBER	CONFIGURATION	QUANTITY PER CARTON (DU)
219563-0033	3P	300

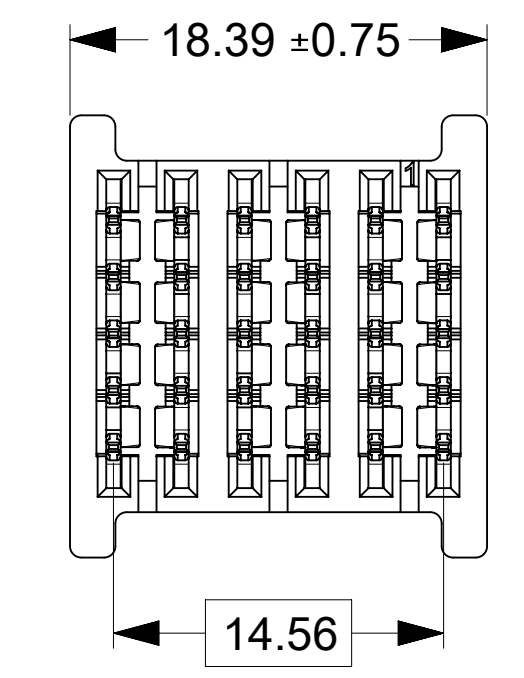

PART NUMBER	CONFIGURATION	QUANTITY PER CARTON (DU)
219563-0034	4P	220

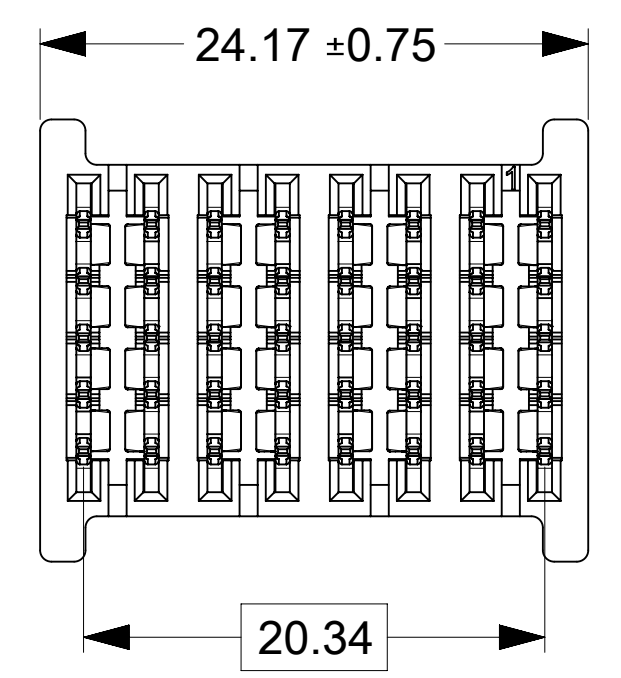

PART NUMBER	CONFIGURATION	QUANTITY PER CARTON (DU)
219563-0035	5P	180

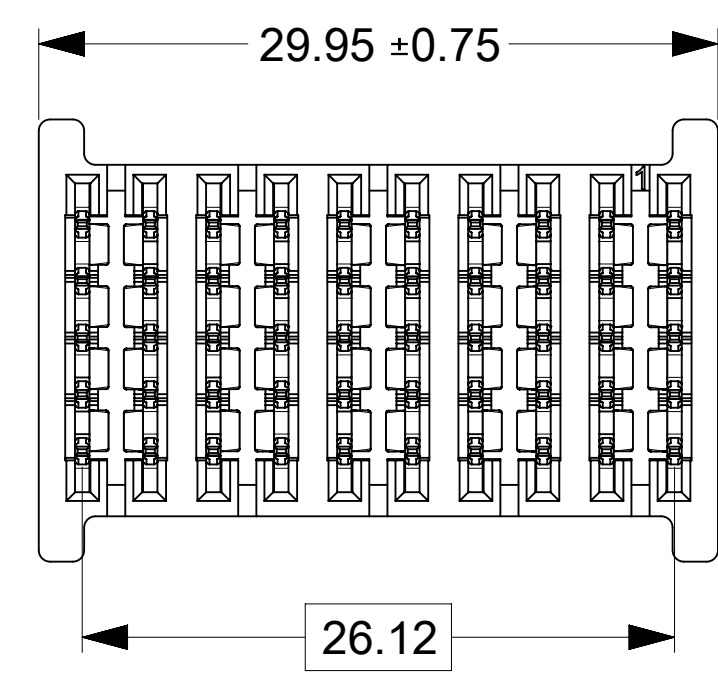

PART NUMBER	CONFIGURATION	QUANTITY PER CARTON (DU)
219563-0036	6P	140

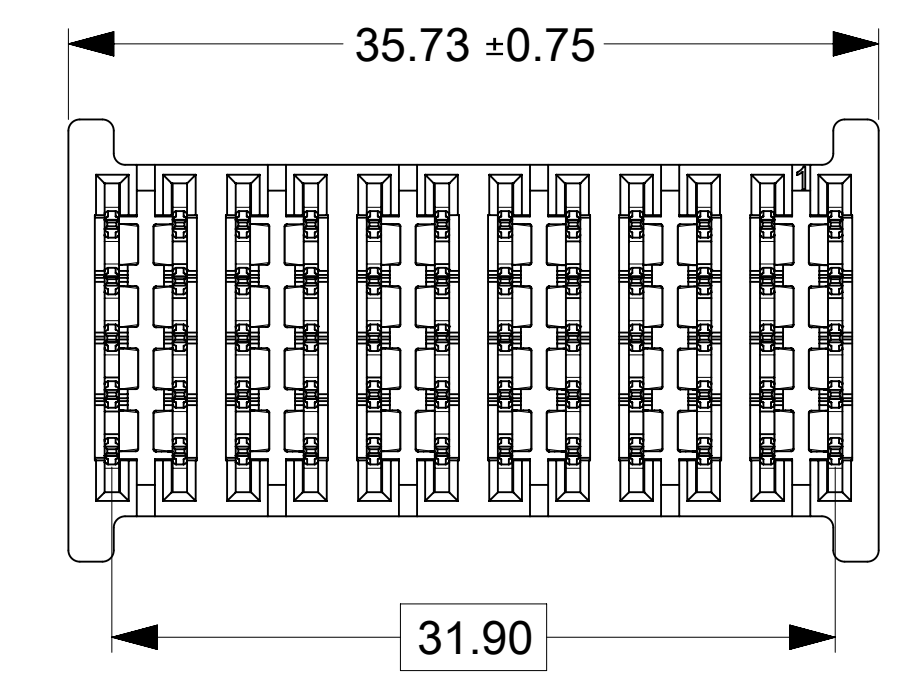

PART NUMBER	CONFIGURATION	QUANTITY PER CARTON (DU)
219563-0037	7P	120

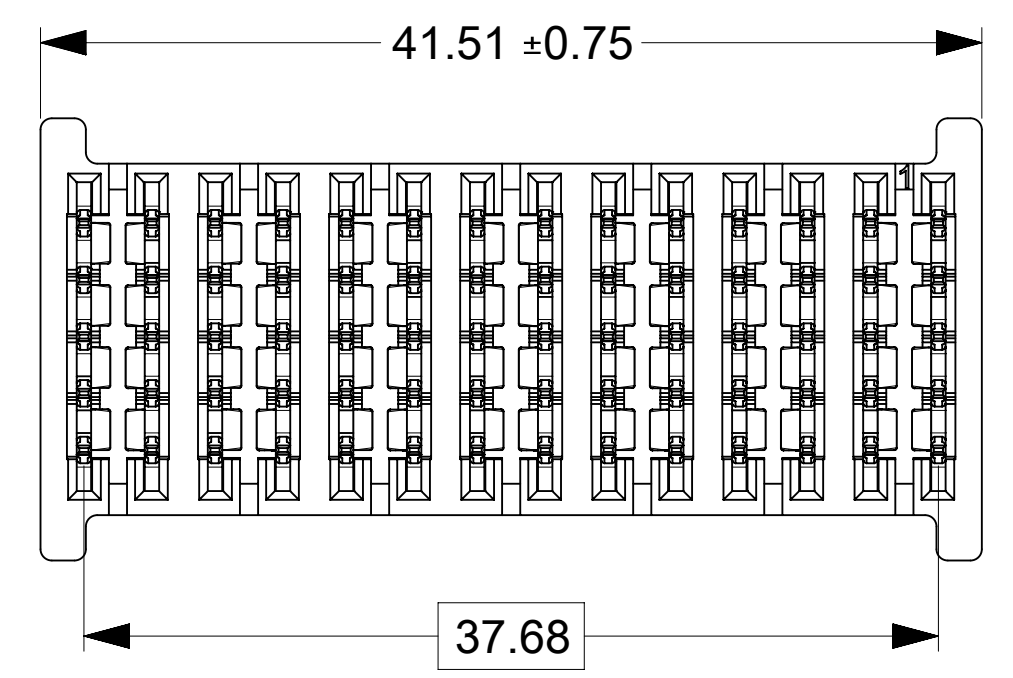

PART NUMBER	CONFIGURATION	QUANTITY PER CARTON (DU)
219563-0038	8P	100

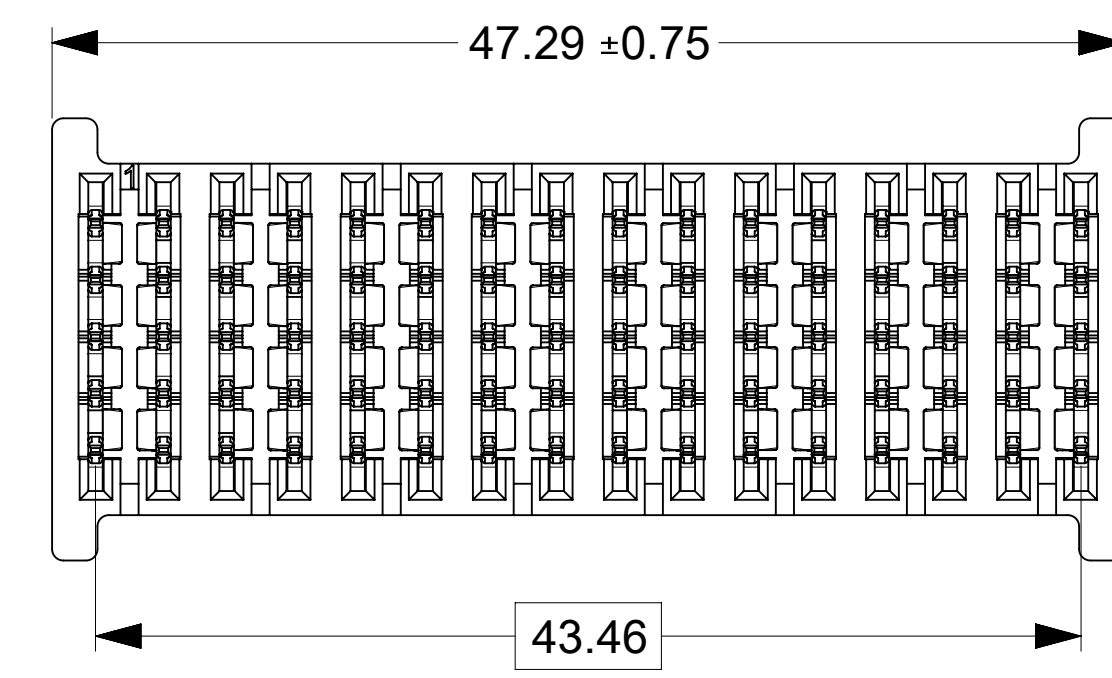

PART NUMBER	CONFIGURATION	QUANTITY PER CARTON (DU)
219563-0039	9P	100

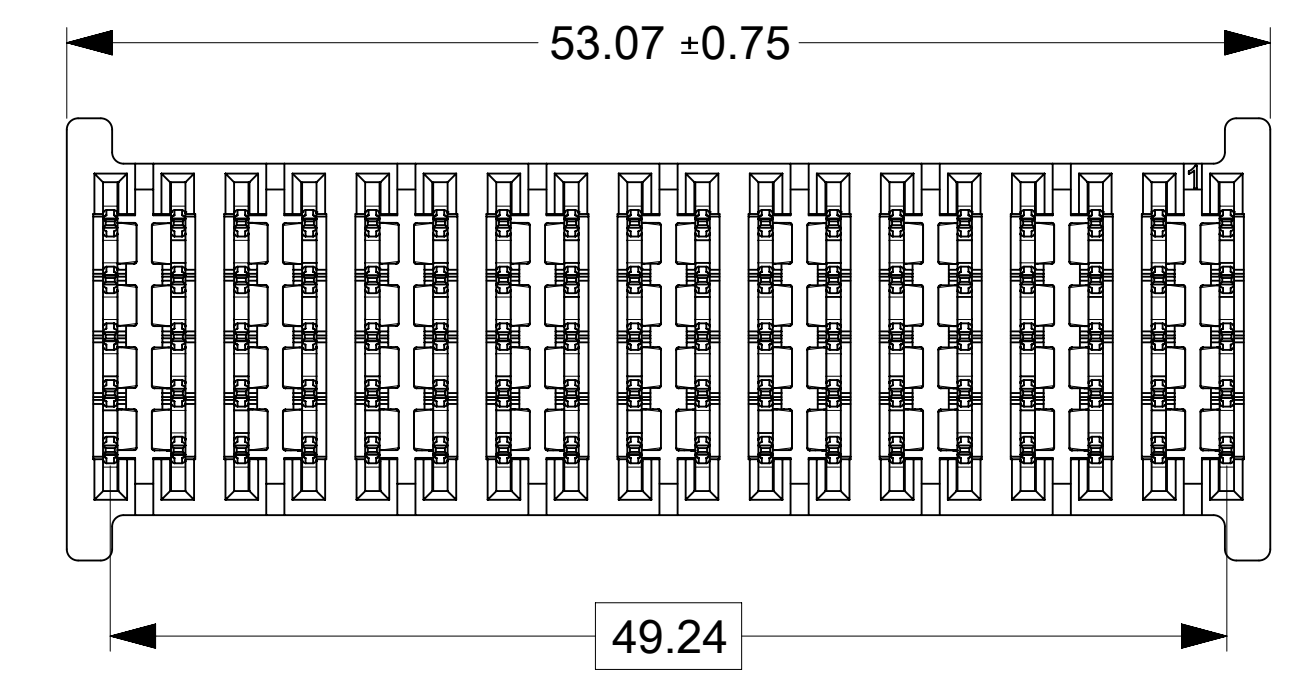

PART NUMBER	CONFIGURATION	QUANTITY PER CARTON (DU)
219563-0040	10P	80

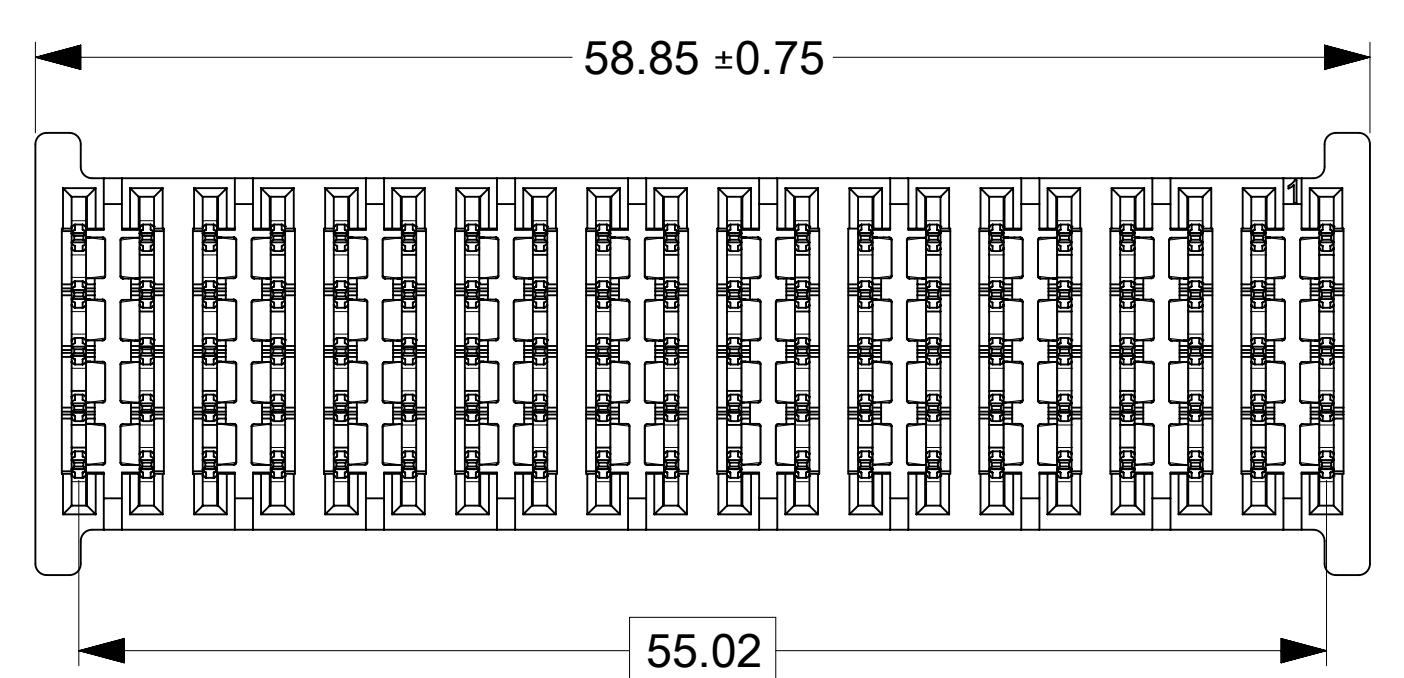

**\* VIEWS SHOWN ON THIS SHEET ARE FROM THE BOTTOM OF THE CONNECTOR**

THIS DRAWING CONTAINS INFORMATION THAT IS PROPRIETARY TO MOLEX ELECTRONIC TECHNOLOGIES, LLC AND SHOULD NOT BE USED WITHOUT WRITTEN PERMISSION											
DIMENSION UNITS		SCALE		CURRENT REV DESC:							
mm		3:1									
GENERAL TOLERANCES (UNLESS SPECIFIED)											
ANGULAR TOL ± °											
4 PLACES ±		3 PLACES ±		2 PLACES ± 0.25		1 PLACE ± 0.3		0 PLACES ±		DRAFT WHERE APPLICABLE MUST REMAIN WITHIN DIMENSIONS	
EC NO: 745288		DRWN: LZABJANOVSKI		2023/03/23		CHK'D: JAYK1		2023/04/10		APPR: JAYK1	
INITIAL REVISION:		DRWN: LZABJANOVSKI		2022/03/30		APPR: BPISZCZOR		2022/08/04		THIRD ANGLE PROJECTION	
DRAWING		SERIES		MATERIAL NUMBER		CUSTOMER		SHEET NUMBER		D-D-SIZE 219563	
SEE CHART		SEE CHART		SEE CHART		SEE CHART		SEE CHART		SEE CHART	
DOCUMENT NUMBER				DOC TYPE		DOC PART		REVISION			
2195639003-SD				PSD		000		A2			
DOCUMENT NUMBER				DOC TYPE		DOC PART		REVISION			
2195639003-SD				PSD		000		A2			

**molex**

GUARDIAN HD VREC POWER ONLY  
UNGUIDED PF

PRODUCT CUSTOMER DRAWING