

5223957-3 ✓ ACTIVE

Z-PACK 2mm HM

TE Internal #: 5223957-3

Backplane Guide Hardware, Guide Socket Module, Z-PACK 2mm HM

[View on TE.com >](#)



Connectors > PCB Connectors > Backplane Connectors > Backplane Guide Hardware

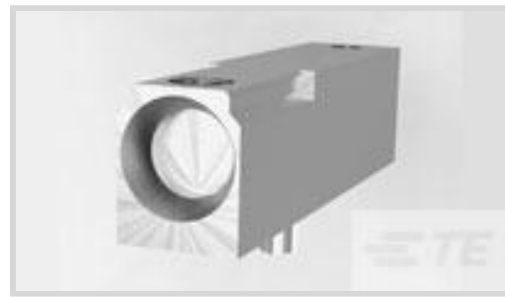

Connector Guide Hardware Type: **Guide Socket Module**

Features

Product Type Features

Connector Guide Hardware Type	Guide Socket Module
-------------------------------	---------------------

Configuration Features

PCB Mount Orientation	Right Angle
-----------------------	-------------

Body Features

Guide Component Plating Material Finish Process	Chromate Conversion Coating
Guide Component Base Material	Zinc Alloy Die Casting

Termination Features

Compatible With Backplane Interface Type	2mm HM
--	--------

Mechanical Attachment

Thread Size	M3 x 0.5
-------------	----------

Dimensions

Product Length	34.2 mm
----------------	---------

Packaging Features

Packaging Quantity	1
Packaging Method	Box

Product Compliance

[For compliance documentation, visit the product page on TE.com>](#)

EU RoHS Directive 2011/65/EU	Compliant
EU ELV Directive 2000/53/EC	Compliant
China RoHS 2 Directive MIIT Order No 32, 2016	No Restricted Materials Above Threshold



EU REACH Regulation (EC) No. 1907/2006

Current ECHA Candidate List: JUNE 2023 (235)

Candidate List Declared Against: JUNE 2023 (235)

Does not contain REACH SVHC

Halogen Content

Low Halogen - Br, Cl, F, I < 900 ppm per homogenous material. Also BFR/CFR/PVC Free

Solder Process Capability

Not applicable for solder process capability

Product Compliance Disclaimer

This information is provided based on reasonable inquiry of our suppliers and represents our current actual knowledge based on the information they provided. This information is subject to change. The part numbers that TE has identified as EU RoHS compliant have a maximum concentration of 0.1% by weight in homogenous materials for lead, hexavalent chromium, mercury, PBB, PBDE, DBP, BBP, DEHP, DIBP, and 0.01% for cadmium, or qualify for an exemption to these limits as defined in the Annexes of Directive 2011/65/EU (RoHS2). Finished electrical and electronic equipment products will be CE marked as required by Directive 2011/65/EU. Components may not be CE marked. Additionally, the part numbers that TE has identified as EU ELV compliant have a maximum concentration of 0.1% by weight in homogenous materials for lead, hexavalent chromium, and mercury, and 0.01% for cadmium, or qualify for an exemption to these limits as defined in the Annexes of Directive 2000/53/EC (ELV). Regarding the REACH Regulation, the information TE provides on SVHC in articles for this part number is based on the latest European Chemicals Agency (ECHA) 'Guidance on requirements for substances in articles' posted at this URL: <https://echa.europa.eu/guidance-documents/guidance-on-reach>

Compatible Parts



TE Part # 223969-7
UNV PWR MDL, GUIDE PIN LOCT PL



TE Part # 223969-4
UNV PWR MDL, GUIDE PIN LOCT PL



TE Part # 120985-1
UNV PWR MDL, GUIDE PIN PLTD



TE Part # 223988-1
UNV PWR MDL, GUIDE PIN PLTD



TE Part # 5223985-5
UPM KEYED GUIDE PIN #6-32



TE Part # 5223985-1
UPM KEYED GUIDE PIN



TE Part # 223982-1
Stainless Steel Guide Pin M4x0.7



TE Part # 5223985-9
UPM KEYED GUIDE PIN



TE Part # 5223985-6
UPM KEYED GUIDE PIN #6-32

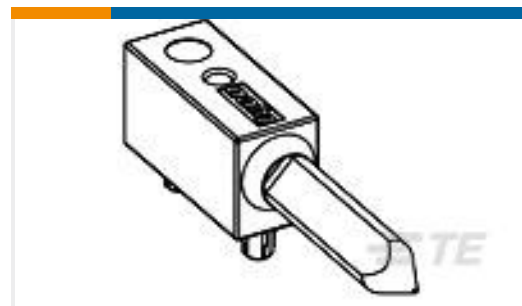

TE Part # 1469265-9
UPM R/A GUIDE PIN



TE Part # 5223985-4
UPM KEYED GUIDE PIN, #6-32



TE Part # 5223985-7
UPM KEYED GUIDE PIN



TE Part # 5223985-8
UPM KEYED GUIDE PIN



TE Part # 223956-1
STV ERMZUB FUEHRUNGSBOLZEN J * M 1 ***



TE Part # 223969-1
UNV PWR MDL, GUIDE PIN LOCT PL



TE Part # 1857988-1
Z-PACK UHD GUIDE PIN



TE Part # 5223985-3
UPM KEYED GUIDE PIN

Also in the Series | Z-PACK 2mm HM

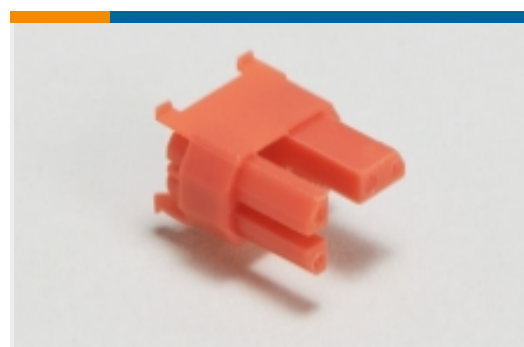

Backplane Coding Keys(60)

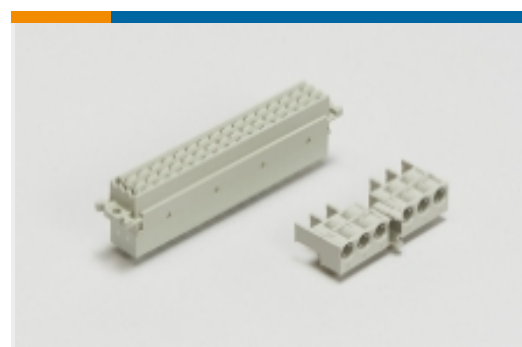

Backplane Connector Housings(4)



Backplane Guide Hardware(37)

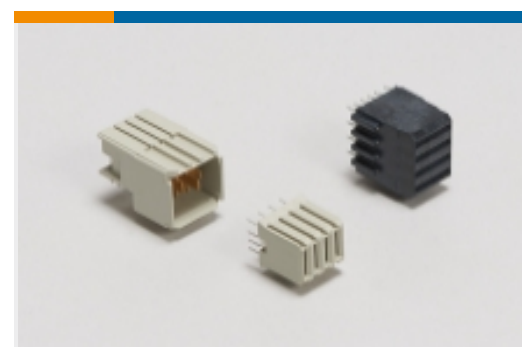

Backplane Power Connectors(6)



Board-to-Board Connector Contacts(2)



Hard Metric Backplane Connectors (269)



High Speed Backplane Connectors(1)



Insertion & Extraction Tools(2)

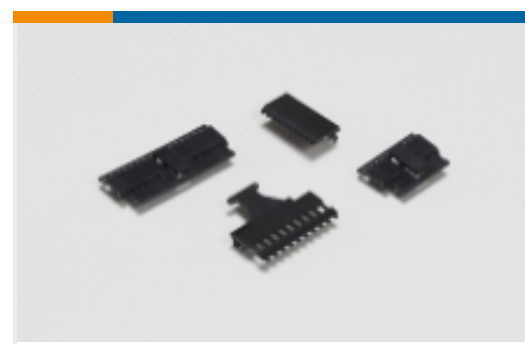

PCB Connector Covers(4)



PCB Connector Shrouds(39)



PCB Ferrules & Shields(19)



Rectangular Power Connectors(87)

Customers Also Bought

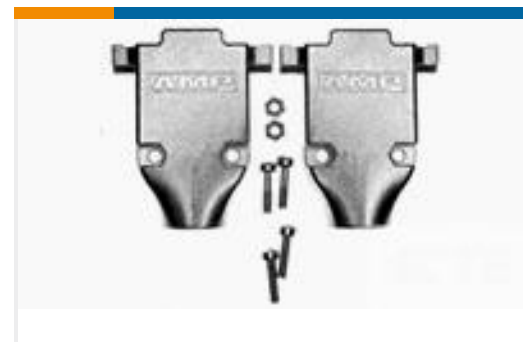
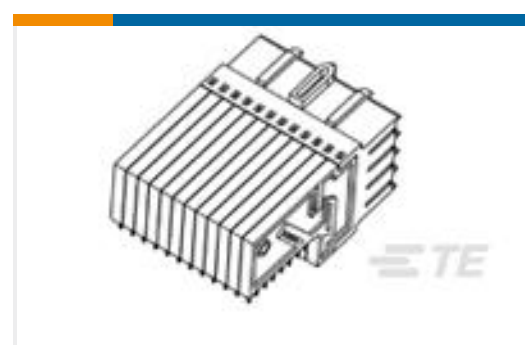
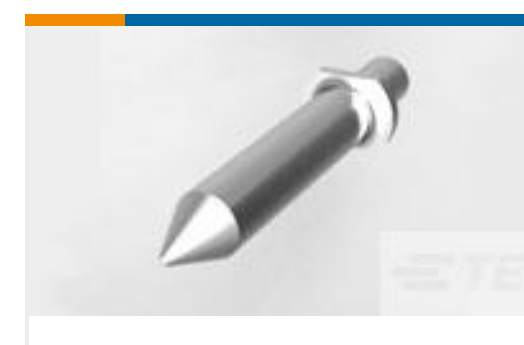
TE Part #5745784-6
37 MSFL RCPT RA 318 (SL,FM)TE Part #5745833-5
CABLE CLAMP KIT,SZ 3TE Part #5-5223961-1
TE UPM R/A Header 3P HC Power, LLLTE Part #6469081-1
HMZD 3PR, RECEPTACLE ASSEMBLYTE Part #1982738-1
Female Connector TelcordiaTE Part #4-794618-8
18P MICRO MNL ASSY R/A HDR LFTE Part #1676228-2
RN 0805 1K27 0.1% 10PPM 1KRLTE Part #223956-1
STV ERMZUB FUEHRUNGSBOLZEN J
* M 1 * * *

Documents

Product Drawings

UPM GUIDE MODULE

English

CAD Files

Customer View Model

[ENG_CVM_CVM_5223957-3_A.2d_dxf.zip](#)

English

3D PDF

3D

Customer View Model

[ENG_CVM_CVM_5223957-3_A.3d_igs.zip](#)

English

Customer View Model

[ENG_CVM_CVM_5223957-3_A.3d_stp.zip](#)

English

By downloading the CAD file I accept and agree to the [Terms and Conditions](#) of use.



Datasheets & Catalog Pages

[2_PIECE_POWER_CONNECTORS_qrg_4-1773458-1](#)

English

Product Specifications

[Engineering Report](#)

English

Product Environmental Compliance

[MD_5223957-3_050720181145_dmtec](#)

English

[MD_5223957-3_050720181145_dmtec](#)

English