

Infrared Light Emitting Diode in Miniature SMD Package

OP251

- Internal Lens
- High Power
- 1206 Package Size
- 880nm Wavelength

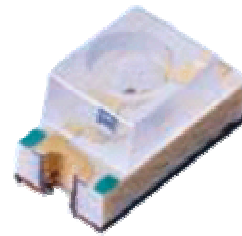

PRELIMINARY

The OP251 is a GaAlAs infrared LEDs mounted in a miniature SMT package. The device incorporates an integral molded lens which enables a tight beam angle and provides an even emission pattern. This device is packaged in a 1206 size chip carrier that is compatible with most automated mounting equipment. The OP251 is mechanically and spectrally matched to the OP520 series phototransistors.

Applications

- Non-Contact Position Sensing
- Datum detection
- Machine automation
- Optical encoders

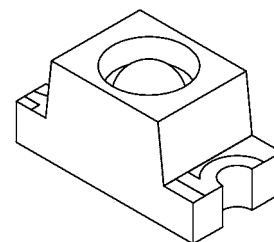
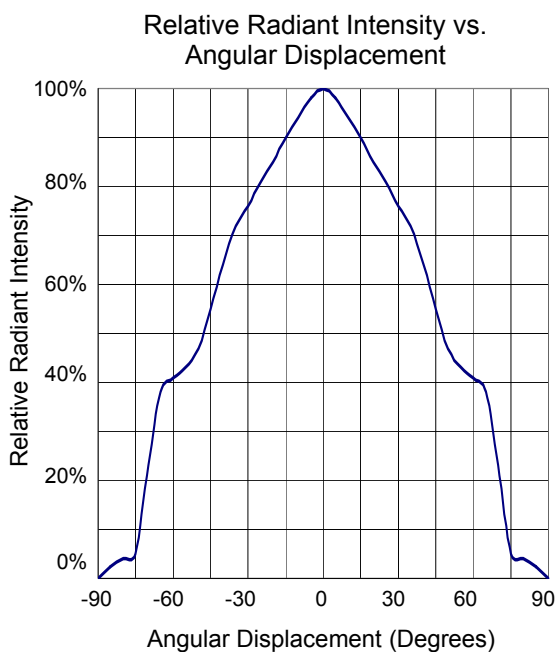

OP251



LEAD FREE

Optek reserves the right to make changes at any time in order to improve design and to supply the best product possible.

Absolute Maximum Ratings

$T_A = 25^\circ\text{C}$ unless otherwise noted

Storage Temperature Range	-40° C to +85° C
Operating Temperature Range	-25° C to +85° C
Lead Soldering Temperature	260° C ⁽¹⁾
Reverse Voltage	30 V
Continuous Forward Current	50 mA
Power Dissipation	130 mW ⁽²⁾

Notes:

- Solder time less than 5 seconds at temperature extreme.
- De-rate linearly at 2.17 mW/° C above 25° C.

Electrical Characteristics ($T_A = 25^\circ\text{C}$ unless otherwise noted)

SYMBOL	PARAMETER	MIN	TYP	MAX	UNITS	CONDITIONS
$E_{e(\text{APT})}$	Apertured Radiant Incidence	0.3			mW/cm ²	$I_F = 20\text{mA}^{(3)}$
V_F	Forward Voltage			1.5	V	$I_F = 20\text{mA}$
I_R	Reverse Current			100	μA	$V_R = 2.0\text{V}$
λ_P	Peak Emission Wavelength		890		nm	$I_F = 10\text{mA}$
Θ_{HP}	Emission Angle at Half Power Points		105		Deg.	$I_F = 20\text{mA}$
t_r, t_f	Rise and Fall Time			500	ns	$I_{F(\text{PEAK})} = 100\text{mA}$, PW = 10μs, 10% D.C.

- $E_{e(\text{APT})}$ is a measurement of the apertured radiant incidence upon a sensing area 0.081" (2.06mm) in diameter, perpendicular to and centered on the mechanical axis of the lens, and 0.590" (14.99mm) from the measurement surface. $E_{e(\text{APT})}$ is not necessarily uniform within the measured area.

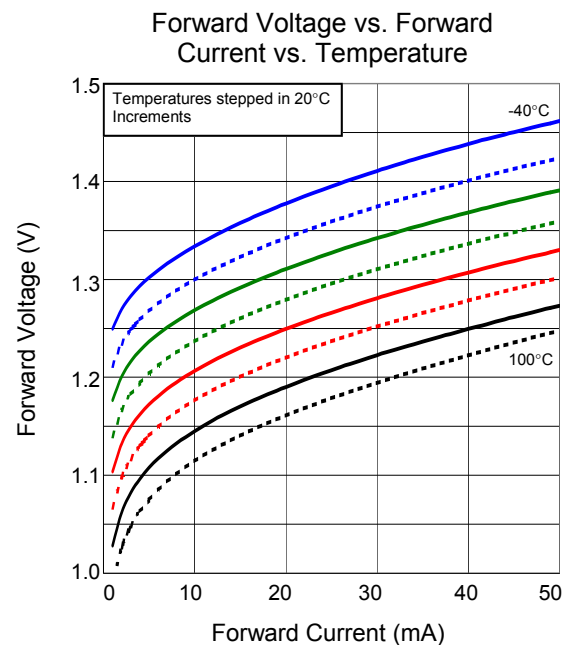
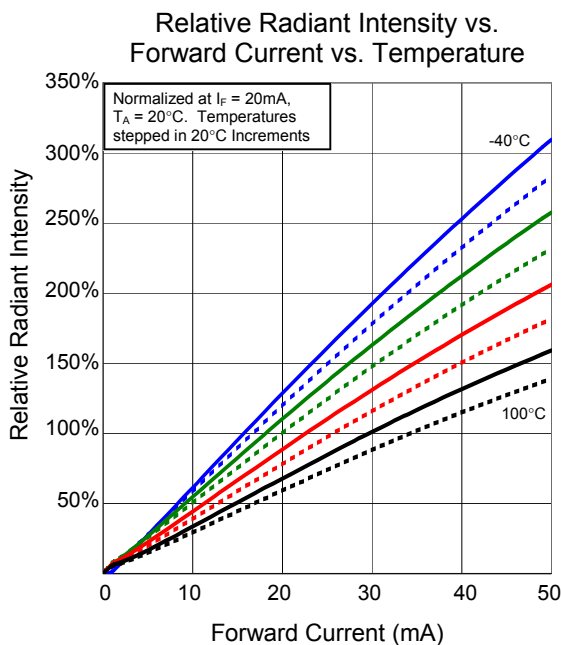

SMD Infrared LED

OP251

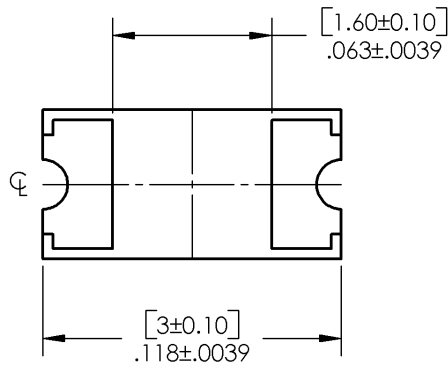
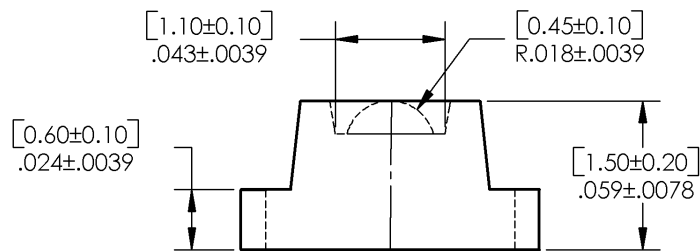
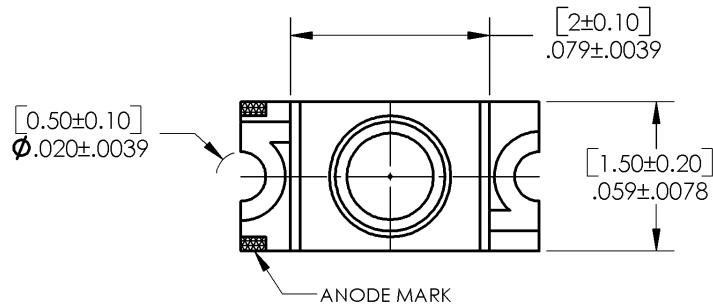

PIN	FUNCTION
1	Anode
2	Cathode

DIMENSIONS ARE IN INCHES AND [MILLIMETERS].

RECOMMENDED SOLDER PADS

