

Property of Lite-On Only

Features

- * Side looking special for LCD backlight.
- * Ultra bright AlInGaP Chip LED.
- * Package in 8mm tape on 7" diameter reels.
- * Compatible with automatic placement equipment.
- * Compatible with infrared and vapor phase reflow solder process.
- * EIA STD package.
- * I.C. compatible.

Package Dimensions

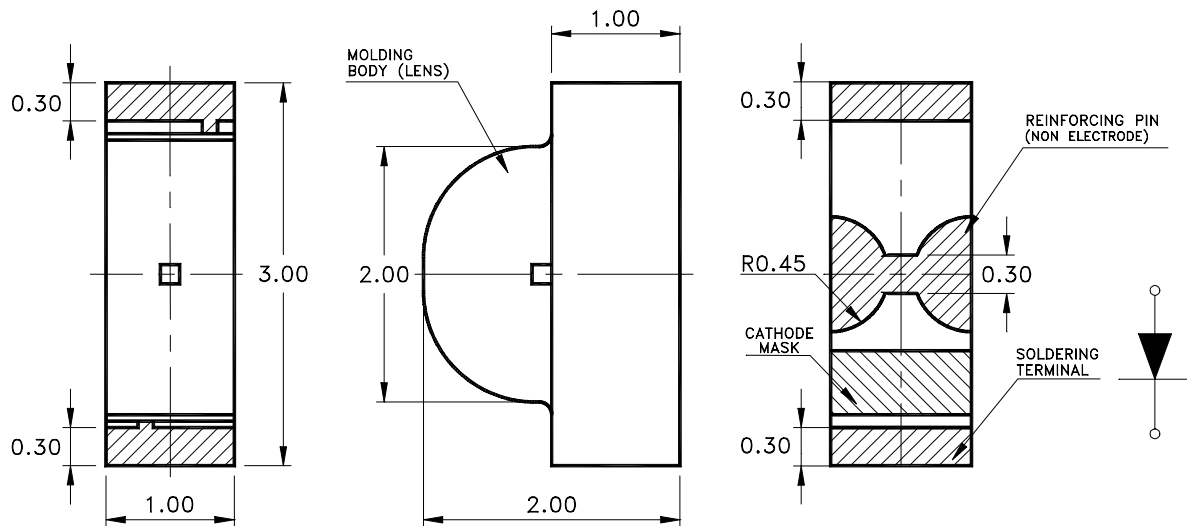

Notes:

1. All dimensions are in millimeters (inches).
2. Tolerance is $\pm 0.1\text{mm}$ (.004") unless otherwise noted.

Devices

Part No.	Lens	Source Color
LTST-S320KAKT	Water Clear	AlInGaP Red Orange
LTST-S320KEKT	Water Clear	AlInGaP Red
LTST-S320KFKT	Water Clear	AlInGaP Yellow Orange
LTST-S320KRKT	Water Clear	AlInGaP Super Red
LTST-S320KSKT	Water Clear	AlInGaP Yellow
LTST-S320KYKT	Water Clear	AlInGaP Amber Yellow

Property of Lite-On Only

Absolute Maximum Ratings At Ta=25°C

Parameter	Part No. LTST-S320						Unit
	KAKT	KEKT	KFKT	KRKT	KSKT	KYKT	
Power Dissipation	75						mW
Peak Forward Current (1/10 Duty Cycle, 0.1ms Pulse Width)	80						mA
Continuous Forward Current	30						mA
Derating Linear From 25°C	0.4						mA/°C
Reverse Voltage	5						V
Operating Temperature Range	-55°C to + 85°C						
Storage Temperature Range	-55°C to + 85°C						
Wave Soldering Condition	260°C For 5 Seconds						
Infrared Soldering Condition	260°C For 5 Seconds						
Vapor Phase Soldering Condition	215°C For 3 Minutes						

Suggested IR Reflow Condition :

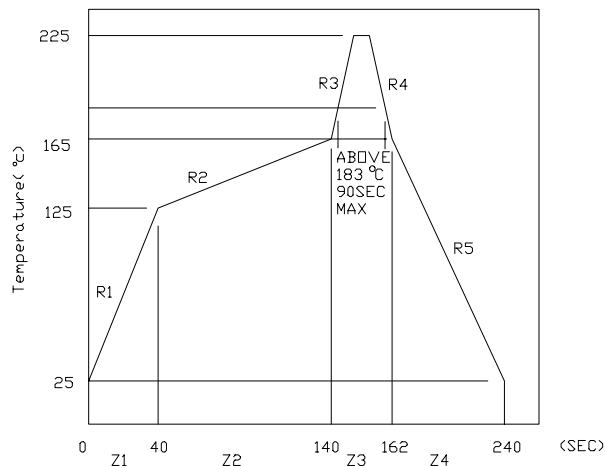



LITE-ON ELECTRONICS, INC.

Property of Lite-On Only

Electrical / Optical Characteristics At Ta=25°C

Parameters	Symbol		Part No. LTST- S320						Unit	Test Condition
			KAKT	KEKT	KFKT	KRKT	KSKT	KYKT		
Luminous Intensity	IV	TYP.	55.0	50.0	60.0	54.0	60.0	50.0	mcd	IF = 20mA Note 1
Viewing Angle	2θ1/2	TYP.	130	130	130	130	130	130	deg	Note 2 (Fig.6)
Peak Emission Wavelength	λP	TYP.	621	632	611	639	588	595	nm	Measurement @Peak (Fig.1)
Dominant Wavelength	λd	TYP.	615	624	605	631	587	592	nm	Note 3
Spectral Line Half-Width	Δλ	TYP.	18	20	17	20	15	16	nm	
Forward Voltage	VF	TYP.	2.0	2.0	2.0	2.0	2.0	2.0	V	IF = 20mA
		MAX.	2.4	2.4	2.4	2.4	2.4	2.4		
Reverse Current	IR	MAX.	100	100	100	100	100	100	μA	VR = 5V
Capacitance	C	TYP.	40	40	40	40	40	40	PF	VF=0, f=1MHZ

- Notes: 1. Luminous intensity is measured with a light sensor and filter combination that approximates the CIE eye-response curve.
2. θ1/2 is the off-axis angle at which the luminous intensity is half the axial luminous intensity.
3. The dominant wavelength, λd is derived from the CIE chromaticity diagram and represents the single wavelength which defines the color of the device.

Property of Lite-On Only

Typical Electrical / Optical Characteristics Curves

(25°C Ambient Temperature Unless Otherwise Noted)

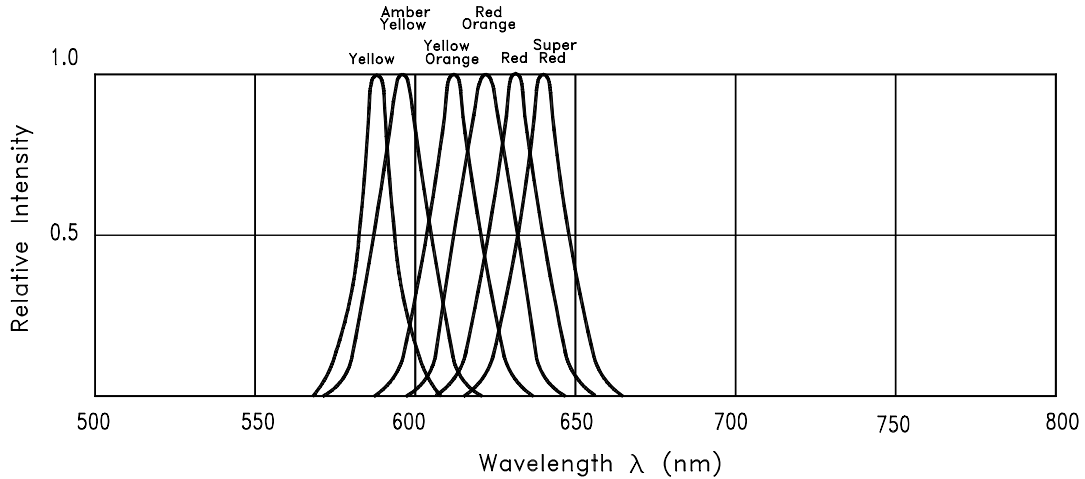

Fig.1 RELATIVE INTENSITY VS. WAVELENGTH

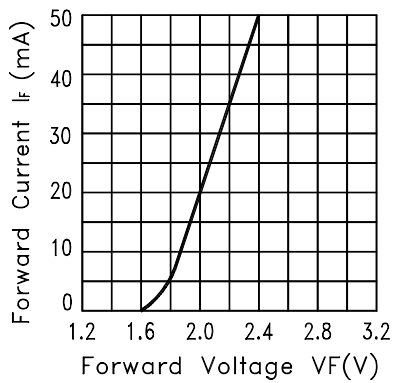

Fig.2 FORWARD CURRENT VS. FORWARD VOLTAGE

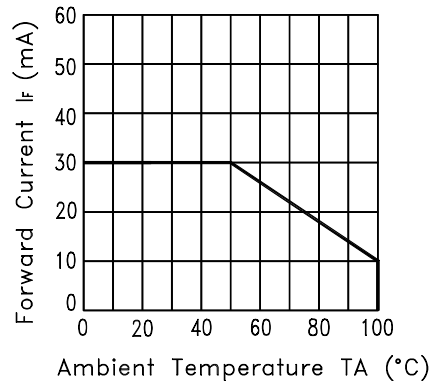

Fig.3 FORWARD CURRENT DERATING CURVE

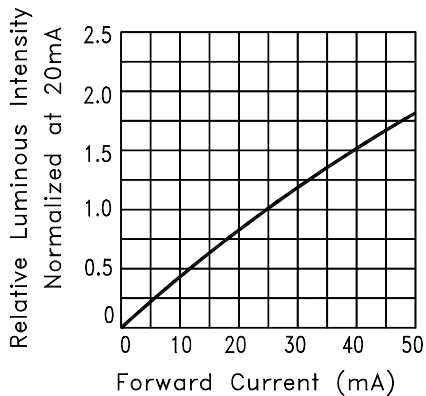

Fig.4 RELATIVE LUMINOUS INTENSITY VS. FORWARD CURRENT

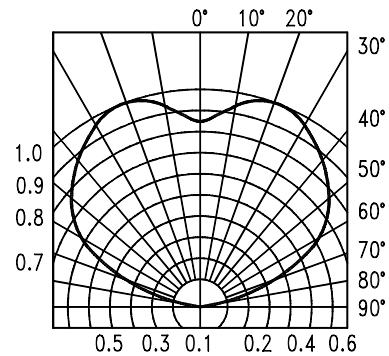

Fig.6 SPATIAL DISTRIBUTION

Property of Lite-On Only

Cleaning

Do not use unspecified chemical liquid to clean LED they could harm the package.
 If clean is necessary, immerse the LED in ethyl alcohol or in isopropyl alcohol at normal temperature for less one minute.

Suggest Soldering Pad Dimensions

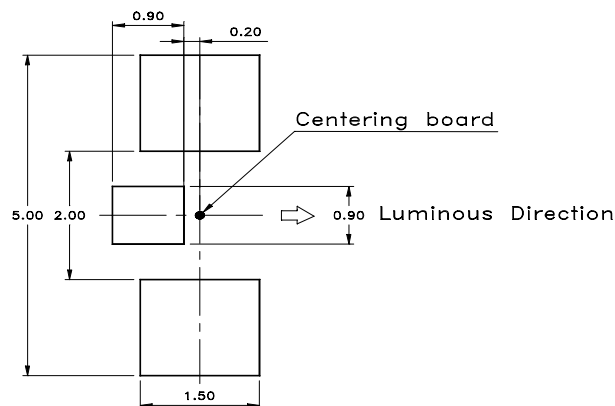

Package Dimensions Of Tape And Reel

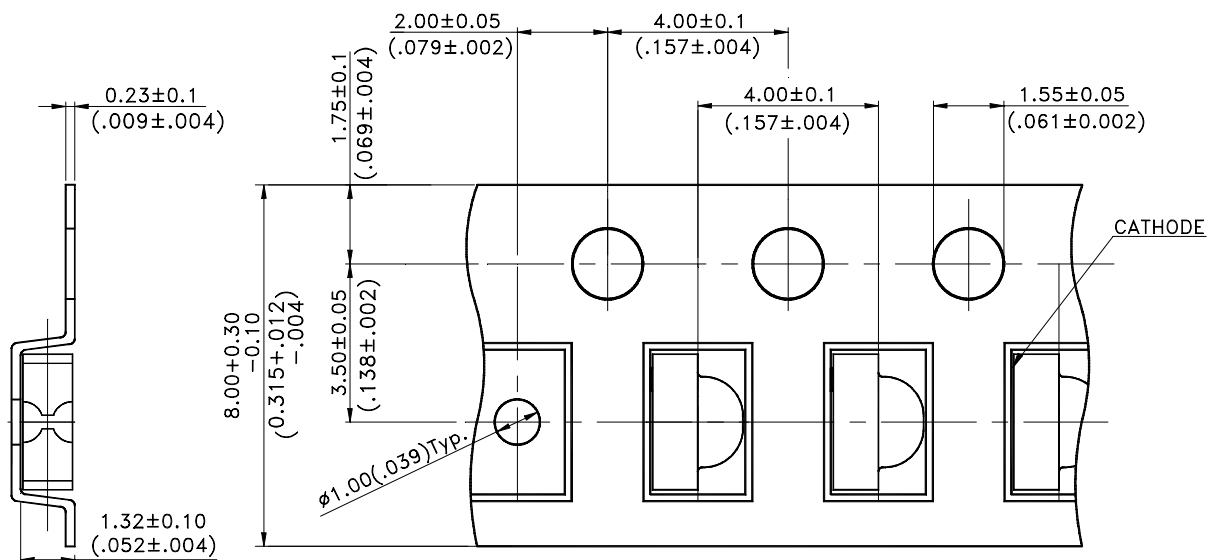

Notes:

1. All dimensions are in millimeters (inches).

Property of Lite-On Only

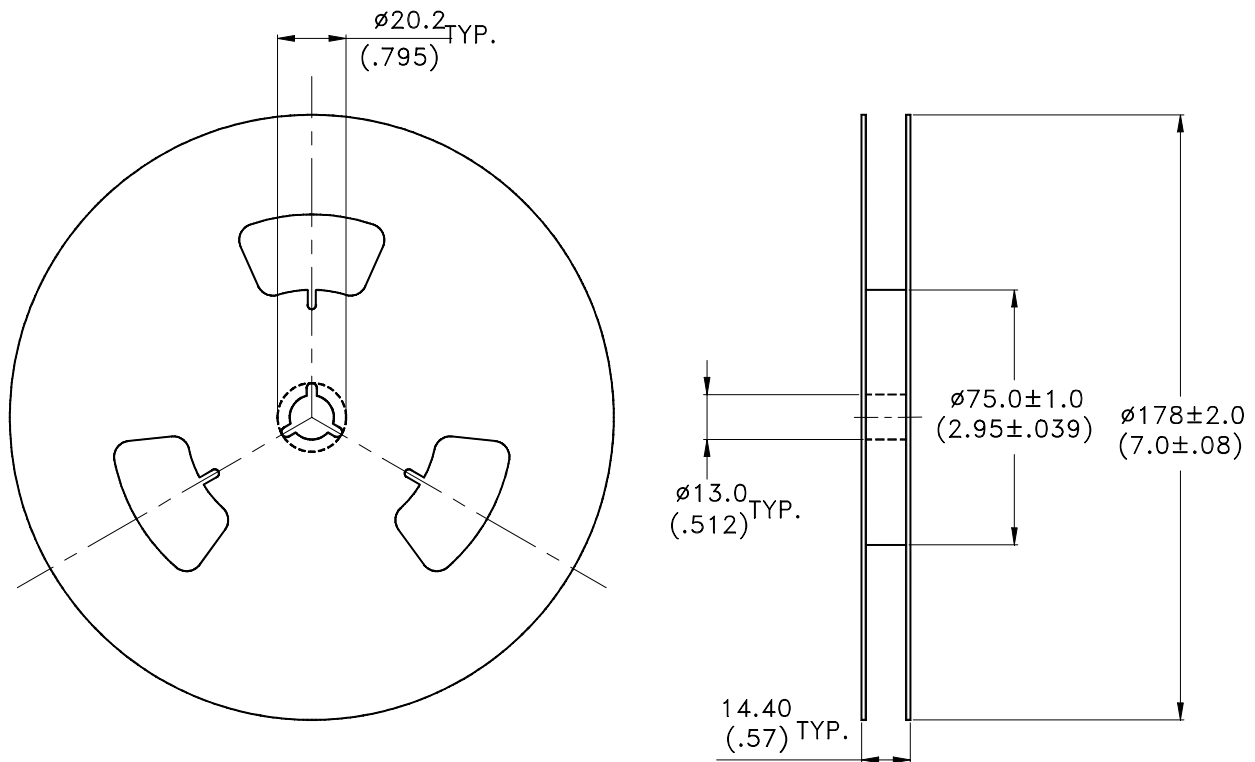

- Notes:
1. Empty component pockets sealed with top cover tape.
 2. 7 inch reel-3000 pieces per reel.
 3. The maximum number of consecutive missing lamps is two.
 4. In accordance with ANSI/EIA 481-1-A-1994 specifications.