



AMP | Timer Connector System

TE Internal #: 963243-1

Single Wire Seal (SWS), Silicone, Blue, 7.2 mm [.283 in] Cavity Diameter, .055 – .083 in [1.4 – 2.1 mm] Insulation Diameter, Timer Connector System

[View on TE.com >](#)

Connectors > Connector Accessories > Connector Seals & Cavity Plugs

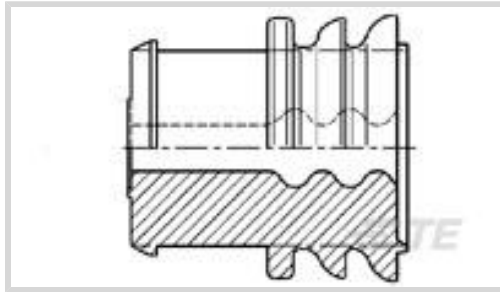

Connector Seal & Plug Type: **Single Wire Seal (SWS)**

Primary Product Material: **Silicone**

Primary Product Color: **Blue**

Cavity Diameter: **7.2 mm [.283 in]**

Compatible Insulation Diameter Range: **1.4 – 2.1 mm [.055 – .083 in]**

Features

Product Type Features

Connector Seal & Plug Type	Single Wire Seal (SWS)
----------------------------	------------------------

Body Features

Primary Product Material	Silicone
Primary Product Color	Blue

Dimensions

Cavity Diameter	7.2 mm [.283 in]
Compatible Insulation Diameter Range	1.4 – 2.1 mm [.055 – .083 in]

Usage Conditions

Operating Temperature (Max)	65 °C, 70 °C, 75 °C, 80 °C, 85 °C, 90 °C, 100 °C, 105 °C, 110 °C, 120 °C, 125 °C, 130 °C [149 °F][158 °F][167 °F][176 °F][185 °F][194 °F][212 °F][221 °F][230 °F][248 °F][257 °F][266 °F]
Operating Temperature Range	-40 – 130 °C [-40 – 266 °F]

Industry Standards

UL Flammability Rating	None
------------------------	------

Other

Resistance to Hydrocarbons	Poor
Shore A Hardness	50



Contains Lubricant	Yes
--------------------	-----

Product Compliance

[For compliance documentation, visit the product page on TE.com>](#)

EU RoHS Directive 2011/65/EU	Compliant
EU ELV Directive 2000/53/EC	Compliant
China RoHS 2 Directive MIIT Order No 32, 2016	No Restricted Materials Above Threshold
EU REACH Regulation (EC) No. 1907/2006	Current ECHA Candidate List: JUNE 2023 (235) Candidate List Declared Against: JUNE 2023 (235) Does not contain REACH SVHC
Halogen Content	Low Halogen - Br, Cl, F, I < 900 ppm per homogenous material. Also BFR/CFR/PVC Free
Solder Process Capability	Not applicable for solder process capability

Product Compliance Disclaimer

This information is provided based on reasonable inquiry of our suppliers and represents our current actual knowledge based on the information they provided. This information is subject to change. The part numbers that TE has identified as EU RoHS compliant have a maximum concentration of 0.1% by weight in homogenous materials for lead, hexavalent chromium, mercury, PBB, PBDE, DBP, BBP, DEHP, DIBP, and 0.01% for cadmium, or qualify for an exemption to these limits as defined in the Annexes of Directive 2011/65/EU (RoHS2). Finished electrical and electronic equipment products will be CE marked as required by Directive 2011/65/EU. Components may not be CE marked. Additionally, the part numbers that TE has identified as EU ELV compliant have a maximum concentration of 0.1% by weight in homogenous materials for lead, hexavalent chromium, and mercury, and 0.01% for cadmium, or qualify for an exemption to these limits as defined in the Annexes of Directive 2000/53/EC (ELV). Regarding the REACH Regulation, the information TE provides on SVHC in articles for this part number is based on the latest European Chemicals Agency (ECHA) 'Guidance on requirements for substances in articles' posted at this URL: <https://echa.europa.eu/guidance-documents/guidance-on-reach>

Compatible Parts

TE Part # 4-1579007-3
EXTRACTION TOOL KIT

TE Part # 1-1579007-6
EXTRACTION TOOL

TE Part # CAT-T4827-T273
TIMER, RECEPTACLE AND TAB

TE Part # CAT-T4827-CH8172
Timer Connector Housing



Also in the Series | **Timer Connector System**

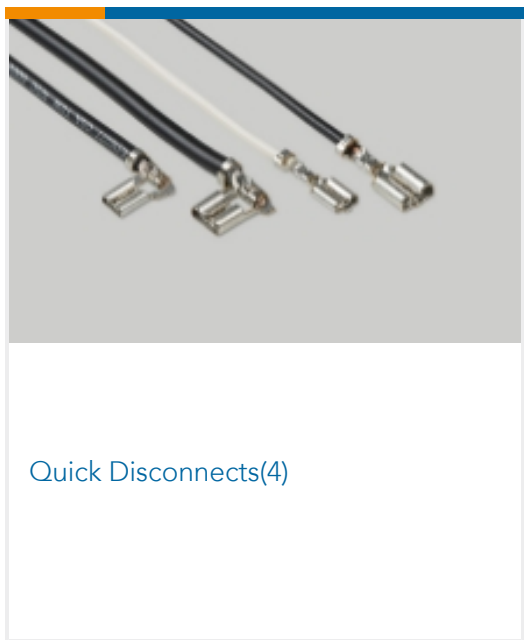
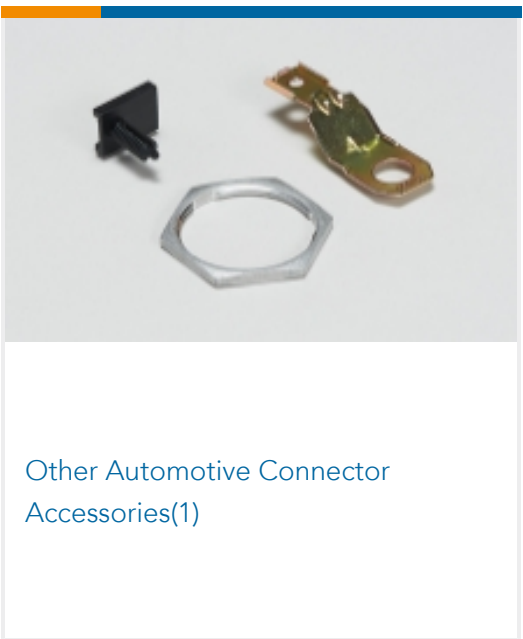
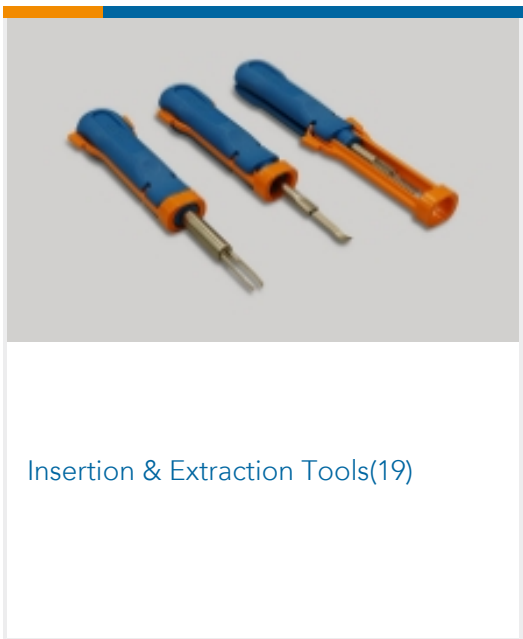
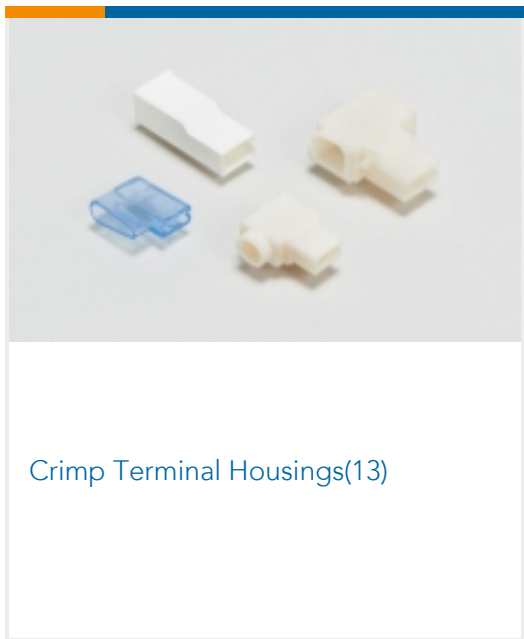
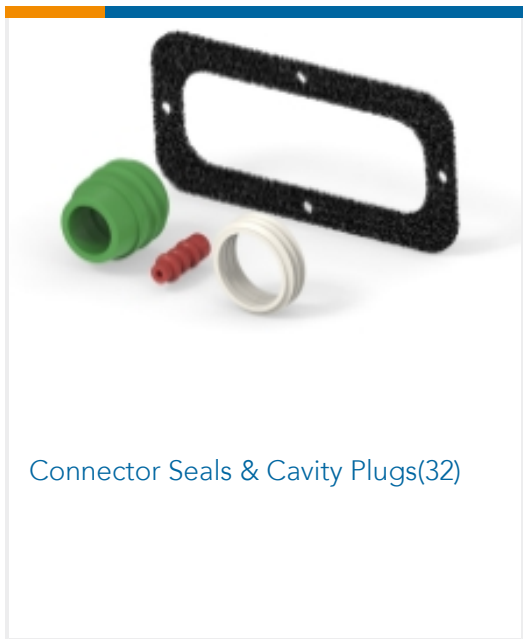
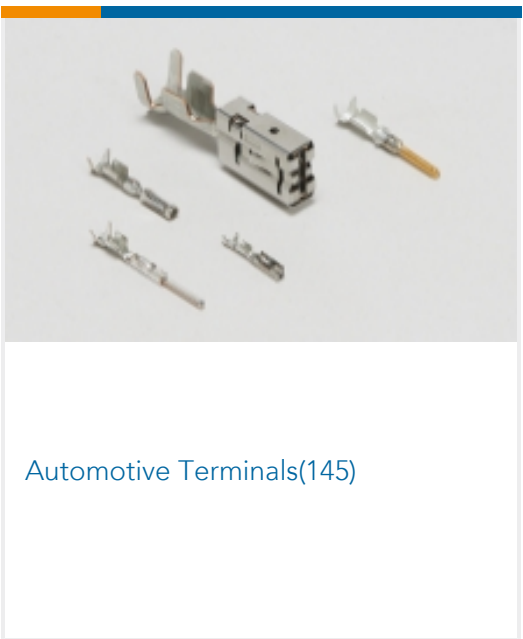
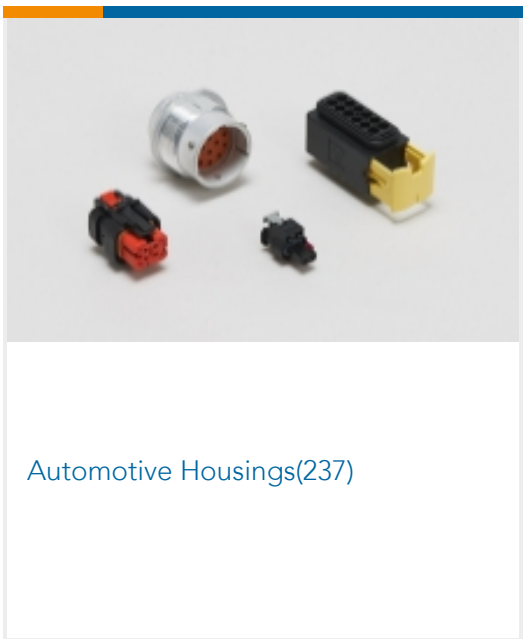
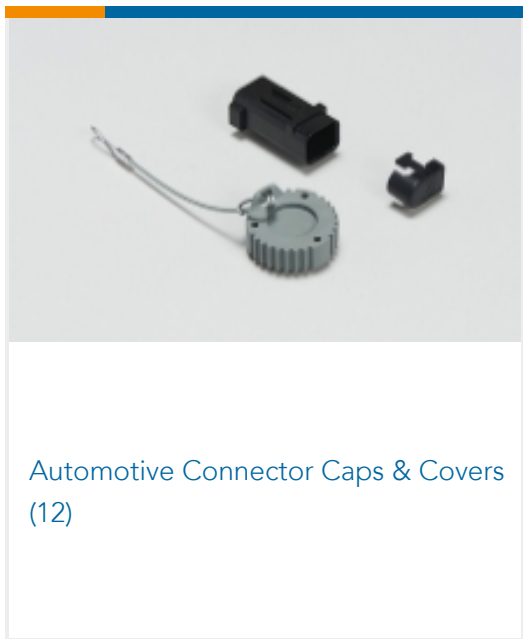

Customers Also Bought

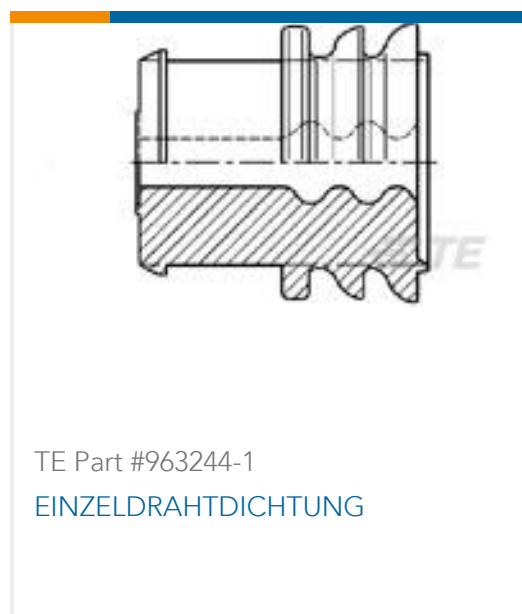

TE Part #963244-1
EINZELDRAHTDICHTUNG

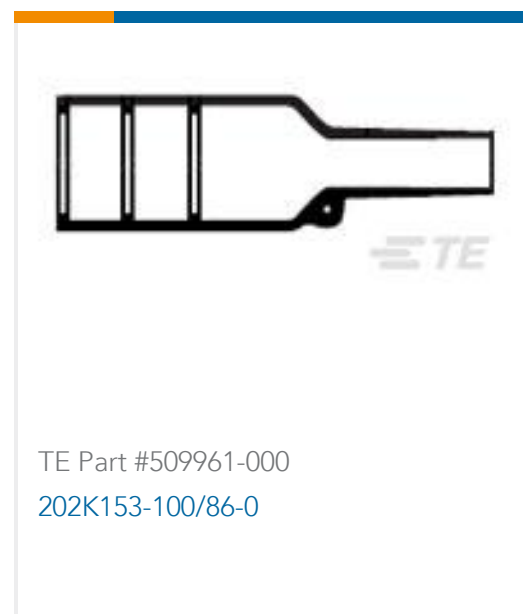

TE Part #509961-000
202K153-100/86-0

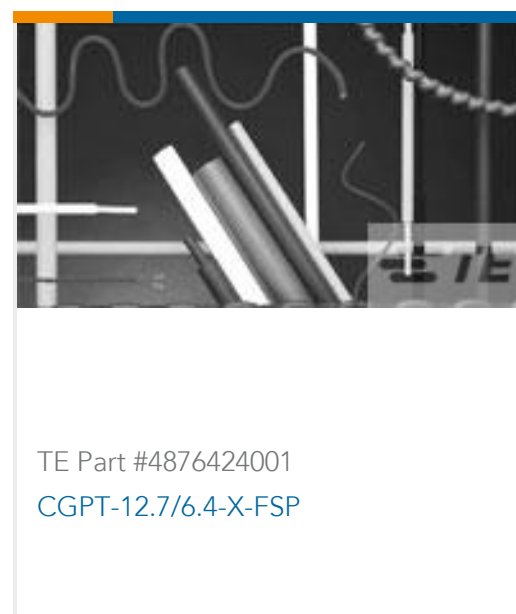

TE Part #4876424001
CGPT-12.7/6.4-X-FSP



TE Part #927836-2
SPT REC 6.3 Contact SWS Sn



TE Part #CV3306-000
RW-175-1/2-X-STK



TE Part #CV3304-000
RW-175-1/4-X-STK



TE Part #5070084031
RNF-100-1/2-X-SP

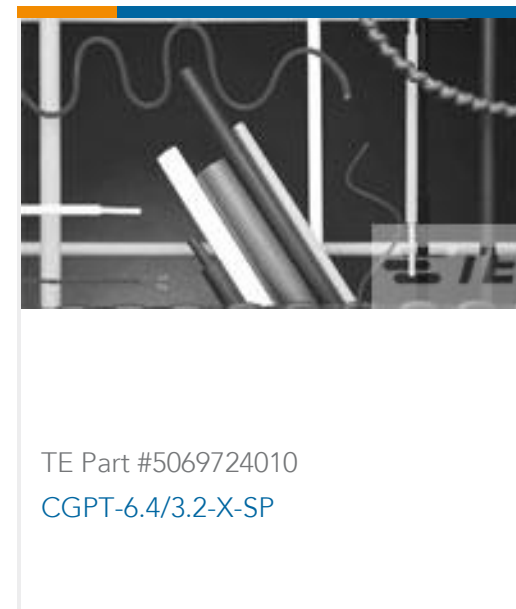

TE Part #5069724010
CGPT-6.4/3.2-X-SP



TE Part #NB08184001
HTAT-8/2-0-SP

Documents

Product Drawings

EINZELDRAHTDICHTUNG

English

CAD Files

Customer View Model

[ENG_CVM_963243-1_B.3d_igs.zip](#)

English

Customer View Model

[ENG_CVM_963243-1_B.3d_stp.zip](#)

English

Customer View Model

[ENG_CVM_963243-1_B.2d_dxf.zip](#)

English

3D PDF

English

By downloading the CAD file I accept and agree to the [Terms and Conditions](#) of use.

Product Specifications



CAVITY PLUG (HYB 38P ISL PLUG)

English

Product Specification

English

5 Position Std Power Timer Splash Proof Female Connector

English

DIESEL GLOW PLUG 1POSITION HOUSING

Japanese

Product Specification

Japanese