

## Sensor/Actuator cable - SAC-5P- 4,0-400/MINFR - 1532195

Please be informed that the data shown in this PDF Document is generated from our Online Catalog. Please find the complete data in the user's documentation. Our General Terms of Use for Downloads are valid (<http://download.phoenixcontact.com>)



Sensor/Actuator cable, 5-position, PVC, Yellow RAL 1021, Free cable end, on Socket angled 7/8"-16UNF, A-coded, Cable length: 4 m

### Product Features

- ✓ Easy and safe: 100% electrically tested plug-in components
- ✓ Robust connectors in size 7/8"-16UNF
- ✓ High-performance: connectors and cables with a large conductor cross section for power supply



### Key commercial data

Packing unit	1 1
Weight per Piece (excluding packing)	380.9 GRM
Custom tariff number	85444290
Country of origin	Germany

### Technical data

#### Dimensions

Length of cable	4 m
-----------------	-----

#### Ambient conditions

Ambient temperature (operation)	-25 °C ... 80 °C (Plug / socket)
Degree of protection	IP65
	IP67
	IP68

#### General

Rated current at 40°C	5.6 A
Rated voltage	300 V
Number of positions	5
Contact resistance	≤ 5 mΩ

## Sensor/Actuator cable - SAC-5P- 4,0-400/MINFR - 1532195

### Technical data

#### General

Insulation resistance	≥ 10 MΩ
Coding	A - standard
Status display	No
Surge voltage category	II
Pollution degree	2
Test voltage	2500 V
Insertion/withdrawal cycles	> 500

#### Material

Inflammability class according to UL 94	HB
Contact material	CuSn
Contact surface material	Au
Contact carrier material	PUR
Material of grip body	PUR
Material, knurls	Nickel-plated brass

#### Cable

Cable type	PVC yellow IEC color code
Conductor cross section	0.75 mm <sup>2</sup>
AWG signal line	18
Conductor structure signal line	41x 0.16 mm
Wire colors	brown, white, blue, black, green-yellow
External sheath, color	Yellow RAL 1021
External cable diameter	6.80 mm
Outer sheath, material	PVC
Ambient temperature (operation)	-10 °C ... 105 °C (cable, fixed installation)
	-5 °C ... 105 °C (cable, flexible installation)

### Classifications

#### eCl@ss

eCl@ss 4.0	27060306
eCl@ss 4.1	27060306
eCl@ss 5.0	27061801
eCl@ss 5.1	27061801
eCl@ss 6.0	27061801
eCl@ss 7.0	27061801
eCl@ss 8.0	27061801

# Sensor/Actuator cable - SAC-5P- 4,0-400/MINFR - 1532195

## Classifications

### ETIM

ETIM 2.0	EC000830
ETIM 3.0	EC001855
ETIM 4.0	EC001855
ETIM 5.0	EC001855

### UNSPSC

UNSPSC 6.01	31251501
UNSPSC 7.0901	31251501
UNSPSC 11	31251501
UNSPSC 12.01	31251501
UNSPSC 13.2	31251501

## Approvals

### Approvals

---

#### Approvals

UL Listed / cUL Listed / cULus Listed

---

#### Ex Approvals

---

#### Approvals submitted

---

## Approval details

UL Listed 	
mm <sup>2</sup> /AWG/kcmil	18
Nominal current I <sub>N</sub>	5.6 A
Nominal voltage U <sub>N</sub>	250 V

# Sensor/Actuator cable - SAC-5P- 4,0-400/MINFR - 1532195

## Approvals

cUL Listed	
mm <sup>2</sup> /AWG/kcmil	18
Nominal current I <sub>N</sub>	5.6 A
Nominal voltage U <sub>N</sub>	250 V

cULus Listed	
--------------	--

## Accessories

### Accessories

#### Conductor marking

Insert label - PABA WH/15 - 1013151



Insert label, Strip, white, Unlabeled, Can be labeled with: Plotter, Mounting type: Thread on, Cable diameter: 0.6-50 mm, Lettering field: 15 x 4 mm

Insert label - PABA YE/15 - 1013698



Insert label, Strip, yellow, Unlabeled, Can be labeled with: Plotter, Mounting type: Thread on, Cable diameter: 0.6-50 mm, Lettering field: 15 x 4 mm

Insert label - PABA RD/15 - 1013944



Insert label, Strip, red, Unlabeled, Can be labeled with: Plotter, Mounting type: Thread on, Cable diameter: 0.6-50 mm, Lettering field: 15 x 4 mm

## Sensor/Actuator cable - SAC-5P- 4,0-400/MINFR - 1532195

### Accessories

#### Cutting tools

Cable-cutting tool - CUTFOX-S VDE - 1212207



Diagonal cutter for copper and aluminum conductors, VDE-tested

---

#### Marker carrier cable

Conductor marker carrier - PATG 2/15 - 1013038



Conductor marker carrier, transparent, Unlabeled, Mounting type: Slide on, Cable diameter: 2-4 mm, Lettering field: 4 x 15 mm

---

Conductor marker carrier - PATG 3/15 - 1013041



Conductor marker carrier, transparent, Unlabeled, Mounting type: Slide on, Cable diameter: 4-7 mm, Lettering field: 4 x 15 mm

---

Conductor marker carrier - PATG 4/15 - 1013054



Conductor marker carrier, transparent, Unlabeled, Mounting type: Slide on, Cable diameter: 6-10 mm, Lettering field: 4 x 15 mm

---

#### Marker pen

## Sensor/Actuator cable - SAC-5P- 4,0-400/MINFR - 1532195

### Accessories

Marker pen - B-STIFT - 1051993



Marker pen, for manual labeling of unprinted Zack strips, smear-proof and waterproof, line thickness 0.5 mm

---

### Protective cap

Screw plug - PROT-MINMS-PA-CHAIN - 1430925



7/8" sealing cap made of plastic with fixing band, for sensor cables, for 7/8" sockets

---

### Screwdriver tools

Adapter insert - TSD-M SAC-BIT ADAPTER - 1212600



Adapter bit for TSD-M...torque tools, E6.3-1/4" drive with 4 mm hexagon to accommodate SAC bits

---

Adapter - SAC BIT MIN-D25 - 1212512



SAC nut, for assembling 7/8" connectors, with 4 mm hexagonal drive

---

### Stripping tool

## Sensor/Actuator cable - SAC-5P- 4,0-400/MINFR - 1532195

### Accessories

Stripping tool - WIREFOX SAC - 1212623



Stripping pliers, for halogen-free sensor/actuator cables (SAC cables), with PUR and PVC insulation, from  $\varnothing$  of 4.4 to 7 mm, any stripping length

---

Stripping tool - WIREFOX 10 - 1212150



Stripping tool, for cables and conductors from 0.02 - 10 mm<sup>2</sup>, self-adjusting, stripping length of up to 18 mm, cutting capacity of up to 10 mm<sup>2</sup> stranded/1.5 mm<sup>2</sup> solid, replaceable stripping blade

---

### Torque tool

Torque screwdriver - TSD 08 SAC - 1212597



Torque screw driver with preset torque of 0.8 Nm, with 4 mm hexagon for accommodating SAC bits, two-component handle with non-slip grip

---

Torque screwdriver - TSD-M 1,2NM - 1212224



Torque screw driver, accuracy as per EN ISO 6789 standard, adjustable from 0.3 - 1.2 Nm

---

### Drawings

# Sensor/Actuator cable - SAC-5P- 4,0-400/MINFR - 1532195

Schematic diagram

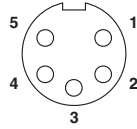

Pin assignment, socket, 7/8"-16UNF, 5-pos., view of female side

Dimensioned drawing

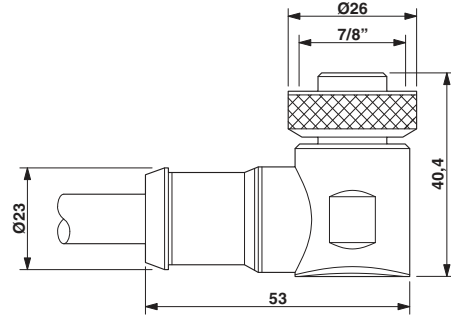

7/8"-16UNF socket, angled

Circuit diagram

