



Power Key 5.0

TE Internal #: 1-1376384-2

Rectangular Power Connectors, Header, Plug, Wire-to-Board, 4 Position, 5 mm [.197 in] Centerline, Printed Circuit Board, UL 94V-0, Power Key 5.0

[View on TE.com >](#)

Connectors > Power Connectors > Rectangular Power > Rectangular Power Connectors

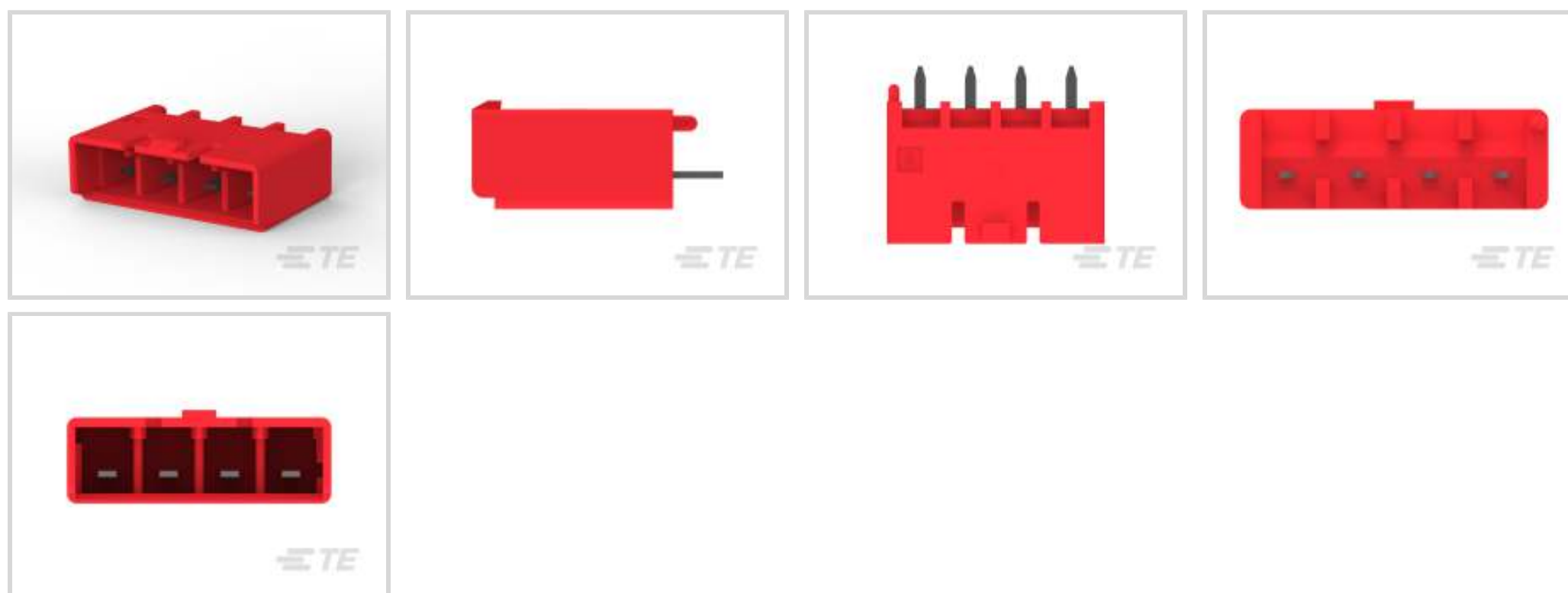

Rectangular Power Connector Type: **Header**

Connector & Housing Type: **Plug**

Connector System: **Wire-to-Board**

Number of Positions: **4**

Centerline (Pitch): **5 mm [.197 in]**

Features

Product Type Features

Header Type	Fully Shrouded
Rectangular Power Connector Type	Header
Connector & Housing Type	Plug
Connector System	Wire-to-Board
Sealable	No
Connector & Contact Terminates To	Printed Circuit Board

Configuration Features

Number of Positions	4
PCB Mount Orientation	Vertical
Number of Power Positions	4
Number of Signal Positions	0
Number of Rows	1

Electrical Characteristics

Operating Voltage	300 VAC
-------------------	---------



Contact Features

Mating Post Length	6.3 mm[.248 in]
PCB Contact Termination Area Plating Material Thickness	1 μ m[39.37 μ in]
Contact Layout	Inline
Contact Mating Area Plating Material	Tin
Contact Base Material	Copper Alloy
Contact Current Rating (Max)	10 A
Contact Retention Within Housing	Without
Contact Type	Tab
PCB Contact Termination Area Plating Material	Tin

Termination Features

Termination Post & Tail Length	3.5 mm[.138 in]
Termination Method to Printed Circuit Board	Through Hole - Solder

Mechanical Attachment

Mating Retention	With
Mating Alignment	Without
PCB Mount Alignment	Without
PCB Mount Retention	With
PCB Mount Retention Type	Mounting Post/Kinked Legs
Mating Retention Type	Latch
Connector Mounting Type	Board Mount

Housing Features

Centerline (Pitch)	5 mm[.197 in]
Housing Color	Red
Housing Material	Nylon 6/6 GF

Dimensions

Connector Height	14.1 mm[.55 in]
PCB Thickness (Recommended)	.06 mm[1.6 in]
Product Width	14.1 mm[.555 in]
Product Length	21.6 mm[.85 in]

Usage Conditions

Operating Temperature Range	-30 – 105 °C[-22 – 221 °F]
-----------------------------	----------------------------



Operation/Application

Circuit Application	Power
---------------------	-------

Industry Standards

CSA Rating	LR 7189
UL Rating	Recognized
Agency/Standard	CSA, UL
Approved Standards	UL E28476
UL Flammability Rating	UL 94V-0
Glow Wire Rating	Standard Part - Not Glow Wire

Packaging Features

Packaging Quantity	100
Packaging Method	Bag

Product Compliance

[For compliance documentation, visit the product page on TE.com>](#)

EU RoHS Directive 2011/65/EU	Compliant
EU ELV Directive 2000/53/EC	Compliant
China RoHS 2 Directive MIIT Order No 32, 2016	No Restricted Materials Above Threshold
EU REACH Regulation (EC) No. 1907/2006	Current ECHA Candidate List: JUNE 2023 (235) Candidate List Declared Against: JAN 2022 (223) Does not contain REACH SVHC
Halogen Content	Not Low Halogen - contains Br or Cl > 900 ppm.
Solder Process Capability	Wave solder capable to 265°C

Product Compliance Disclaimer

This information is provided based on reasonable inquiry of our suppliers and represents our current actual knowledge based on the information they provided. This information is subject to change. The part numbers that TE has identified as EU RoHS compliant have a maximum concentration of 0.1% by weight in homogenous materials for lead, hexavalent chromium, mercury, PBB, PBDE, DBP, BBP, DEHP, DIBP, and 0.01% for cadmium, or qualify for an exemption to these limits as defined in the Annexes of Directive 2011/65/EU (RoHS2). Finished electrical and electronic equipment products will be CE marked as required by Directive 2011/65/EU. Components may not be CE marked. Additionally, the part numbers that TE has identified as EU ELV compliant have a maximum concentration of 0.1% by weight in homogenous materials for lead, hexavalent chromium, and mercury, and 0.01% for cadmium, or qualify for an exemption to these limits as defined in the Annexes of Directive 2000/53/EC (ELV). Regarding the REACH Regulation, the information TE provides on SVHC in articles for this part number is based on the latest European Chemicals Agency (ECHA) 'Guidance on requirements for substances in articles' posted at this URL: <https://echa.europa.eu/guidance-documents/guidance-on-reach>

Compatible Parts



TE Part # CAT-P8704-P729
STD Temp Power Key Plug



TE Part # 1-1376384-5
5mm B-T-W Conn. 4P HDR ASSEMBLY (GWT)



TE Part # 1-1376437-2
5MM POWER KEY 2P HDR ASSY RED



TE Part # 1-1376384-6
5mm B-T-W Conn. 4P HDR ASSEMBL

Also in the Series | Power Key 5.0



Insertion & Extraction Tools(1)



PCB Latches, Locks & Retainers(4)



Power Contacts(4)



Rectangular Power Connectors(107)

Customers Also Bought



TE Part #1-1376383-2
5mm B-T-W Conn. 3P HDR ASSEMBL



TE Part #1376383-1
5mm B-T-W Conn. 3P HDR ASSEMBL



TE Part #1-1123723-0
3.96 EP HDR ASSY 10P(NATURAL)



TE Part #1-1123724-2
3.96EP HDR ASSY 2(3)P NATURAL



TE Part #1376385-1
5mm B-T-W Conn. 6P HDR ASSEMBL

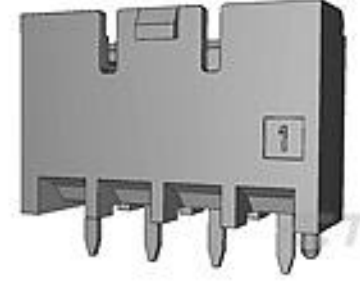

TE Part #1376384-1
5mm B-T-W Conn. 4P HDR ASSEMBL



TE Part #4-1123723-5
3.96 EP HDR ASSY 5P(RED)



TE Part #1-1969730-1
EP2.5 SHROUDED HDR ASSY 11P VERTICAL

Documents

Product Drawings

5mm B-T-W Conn. 4P HDR ASSEMBL

English

CAD Files



3D PDF

3D

Customer View Model

[ENG_CVM_CVM_1-1376384-2_J.2d_dxf.zip](#)

English

Customer View Model

[ENG_CVM_CVM_1-1376384-2_J.3d_igs.zip](#)

English

Customer View Model

[ENG_CVM_CVM_1-1376384-2_J.3d_stp.zip](#)

English

By downloading the CAD file I accept and agree to the [Terms and Conditions](#) of use.

Datasheets & Catalog Pages

[SOFT_SHELL_PIN_SOCKET_CONNECTORS_STANDARD_DENSITY](#)

English

[1-1773881-9 Power Key Connector Quick Reference Guide](#)

English

Product Specifications

[5.0 POWER KEY CONNECTOR](#)

Japanese

[Application Specification](#)

Japanese

Product Environmental Compliance

[Product Compliance](#)

English

[Product Compliance](#)

English

Agency Approvals

[VDE Certificate](#)

English