

Datasheet

0.69-0.96GHz & 1.7-4.2GHz Internal Antenna



95x15x0.20 mm

FPC Antenna

Features:

Flexible embedded and high performing full 4G LTE / 5G NR band antenna with OD1.37mm coaxial cable for indoor applications.

Applications:

- CPE - Router, Set-top boxes & Gateway
- IoT devices
- 4G LTE & 5G NR Mesh
- Smart Metering
- Robotics



Electrical Specifications

Antenna Characteristics

Antenna Type	Radiation Pattern	Polarization	Max. Input Power	Impedance
FPC Antenna	Omni	Linear	1W	50Ω

Frequency (GHz)	0.698~0.96	1.71~2.17	2.3~2.69	3.3~4.2
Return Loss (dB)	< -6	< -6	< -6	< -6
Peak Gain (dBi)	3.1	4.4	4.7	2.7
Average Gain (dB)	-3.7	-3.3	-2.3	-2.0
Average Efficiency (%)	42	47	59	63

Mechanical Specifications

Environmental

Temperature Range (°C)	-40 to 85
Humidity	Non-condensing 65°C 95% RH

RoHS Compliant

Part Number	Dim. (mm)	Weight (g)	Conn. Type	Cable Type	Material	Adhesive
ST0412-20-001-A	95 × 15 × 0.2	1.55	I-PEX MHF 1	Ø 1.37	PI	3M 467

Mechanical Drawing

Unit : mm

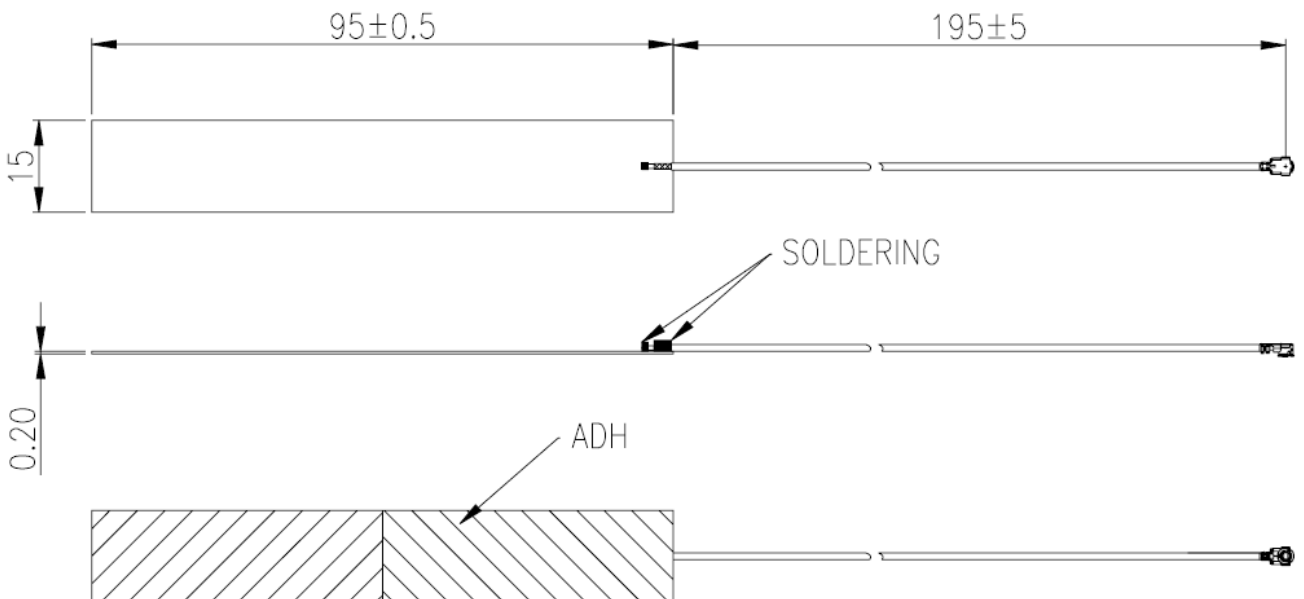

Cable options available

ST0412-20-001-A

Charts In Free Space

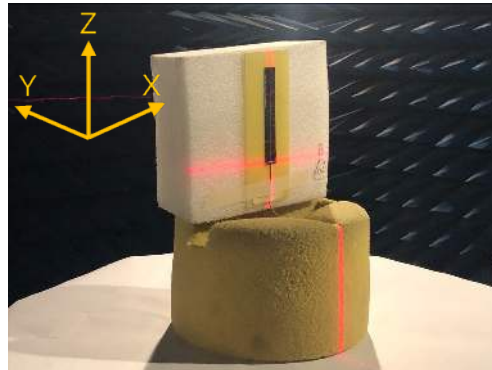

Test setup, measurement performed in 3D anechoic chamber.

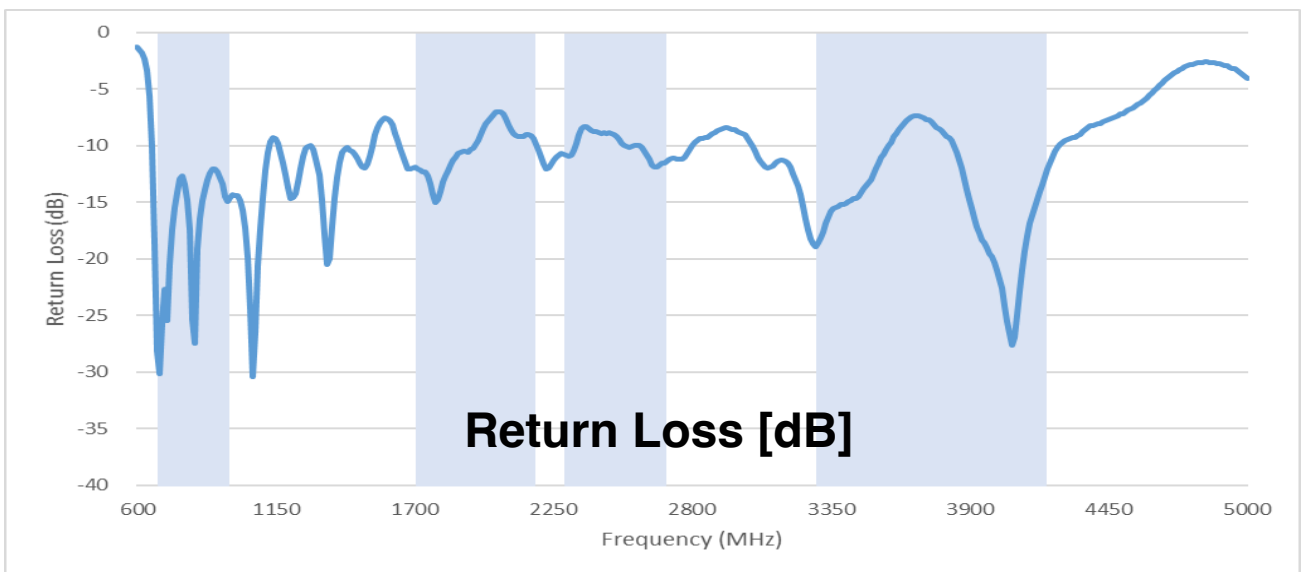

Blue background represents frequency response.

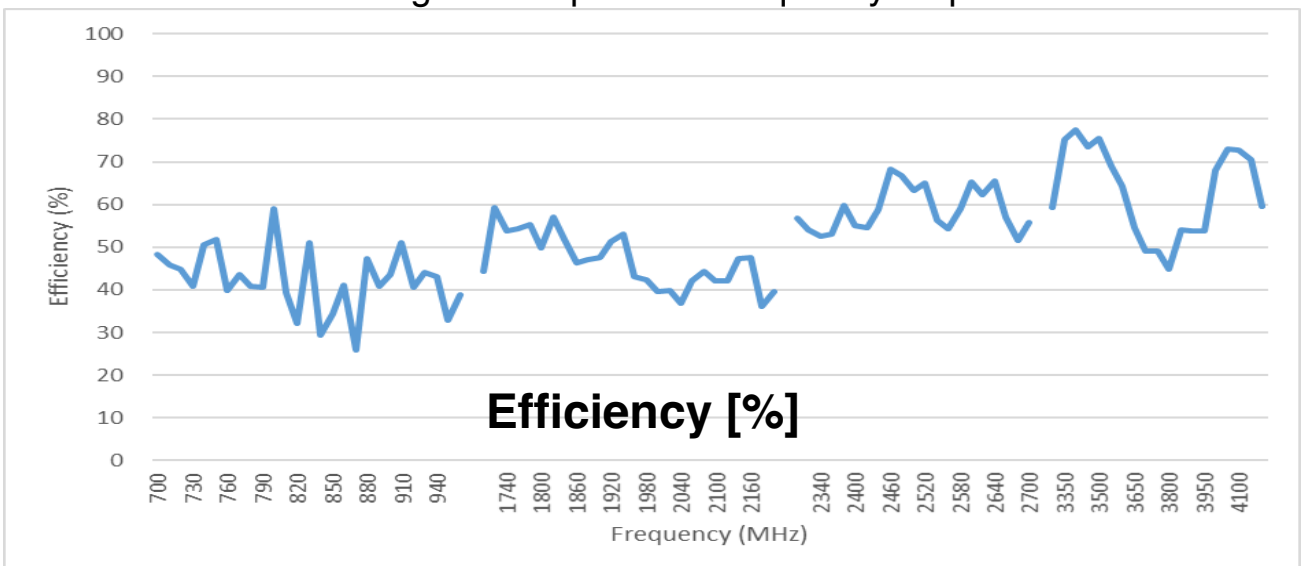

Radiation Pattern - Free Space

XY - Plane

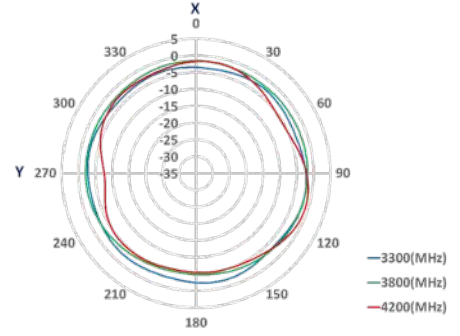
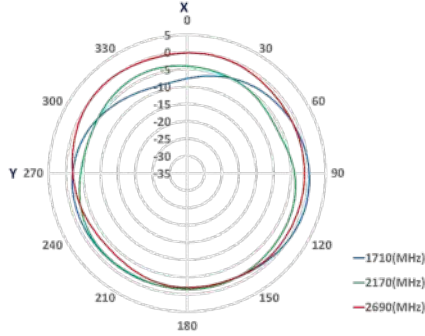
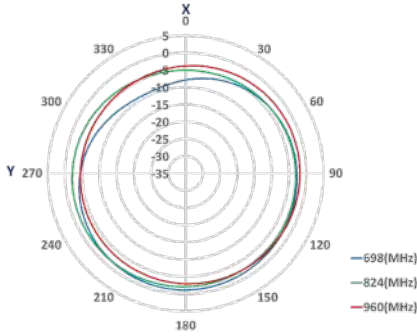

YZ - Plane

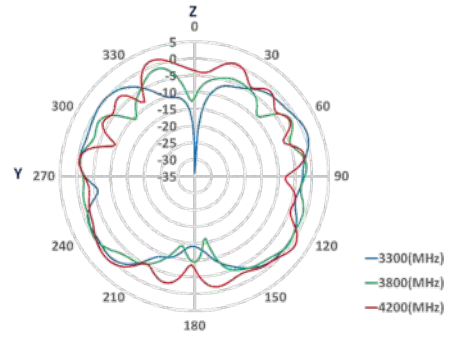
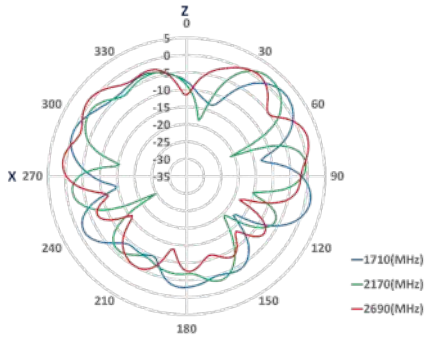
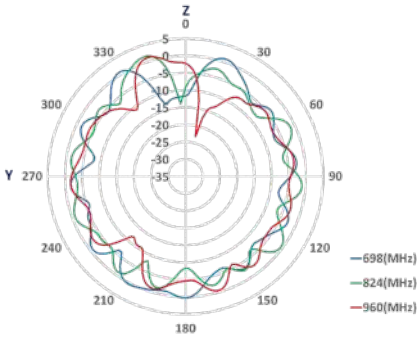

XZ - Plane

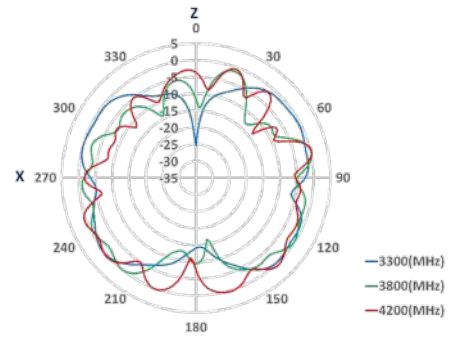
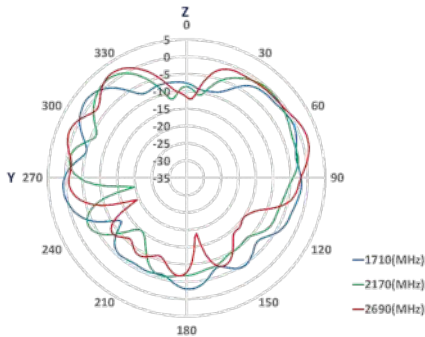
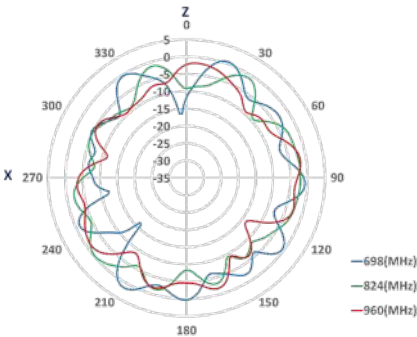

Revisions

Rev	Description	Date	ECN	Approval
A	Initial Release	2022-10-25	ST0412-20-001-A-RA00	ATC
B	Additional info added. RF Performance update.	2023-01-02	ST0412-20-001-A-RB00	ATC

NOTICE - These drawings, specifications, or other data (1) are, and remain the property of Amphenol corp. (2) must be returned upon request; and (3) are confidential and not to be disclosed to any person other than those to whom they are given by Amphenol Corp. the furnishing of these drawings, specifications, or other data by Amphenol Corp., or to any other person to anyone for any purpose is not to be regarded by implication or otherwise in any manner licensing, granting rights to permitting such holder or any other person to manufacture, use or sell any product, process or design, patented or otherwise, that may in any way be related to or disclosed by said drawings, specifications, or other data.