



Bridgelux® Vero® SE 18 Array

Product Data Sheet DS122



Introduction

Vero SE



Vero® SE Series is a revolutionary light source system that integrates Bridgelux's seventh generation COB technology with poke-in connectivity enabling solder-free installation. Vero SE LED light sources streamline assembly processes, lower manufacturing cost, simplify luminaire design, improve light quality and increase design flexibility.

Vero SE is available in four different light emitting surface (LES) configurations that operate reliably over a broad current range. With Vero SE, secondary connector and holder components are not required, allowing for rapid integration of arrays into fixtures and an efficient field replaceable solution. Vero SE arrays deliver increased lumen density for improved beam control and precision lighting with 2 and 3 SDCM color control standards for clean and consistent uniform lighting.

Bridgelux Décor Series is our state of the art color line designed specifically for premium applications, producing unmatched LED light quality with brilliant color-rendering options and offer pleasing and inspiring lighting palettes. Bridgelux Décor Series color points are available on Vero® SE Series, Vero® Series, V Series™ and V Series™ HD.

Décor Series Class A is based on human response testing, providing color points with a combined GAI and CRI metric.

Décor Series™ Ultra products provide a high CRI of 97 and a minimum R9 value of 93, which emphasizes the reds and color tones to which the human eye is most receptive - perfect for the most luxurious retail shops and world renowned museums. Décor Series Ultra is also a good replacement for halogen lamps.

Décor Series™ Food products offer color points developed to address the unique requirements of the food, grocery, and restaurant industries. Highlighting the distinctive colors and nuanced patterns found in meats and breads, the Décor Series Food products are a must have for any butcher counter or bakery.

Décor Series™ Entertainment products provide color points developed specifically for the healthcare and entertainment industries. The 5600K cool white color point combined with a CRI of 90 or 97 provides the bright white required by these industries.

Décor Series™ Street and Landmark is designed to be a direct replacement for high pressure sodium lamps.

Décor Series™ Showcase is the optimal solution for replacing ceramic metal halide lamps, incorporating the same pure white light with enhanced spectrum coverage and higher efficacy.

Features

- Poke-in connectivity
- Efficacy of 157 lm/W typical
- Lumen output performance ranges from 1,372 to 13,060 lumens
- Broad range of CCT options from 1750K to 6500K
- CRI options: minimum 65, 70, 80, and 90
- Color control: 2 and 3 SDCM for 2700K-4000K CCT
- Reliable operation at up to 2X nominal drive current
- Radial die pattern and improved lumen density
- Top side part number markings
- No exposed solder pads or electrical connections
- V_r bin code backside marking

Benefits

- Poke-in connectivity enables solderless, connector free installation
- Broad application coverage for interior and exterior lighting
- Flexibility for application driven lighting design requirements
- High quality, true color reproduction
- Uniform consistent white light
- Flexibility in design optimization
- Enhanced ease of use and assembly
- Ability to configure multiple Vero SE arrays in series and parallel reduces customer driver cost
- Improved inventory management and quality control

Contents

Product Feature Map	2
Product Nomenclature	2
Product Selection Guide	3
Performance at Commonly Used Drive Currents	10
Electrical Characteristics	20
Eye Safety	21
Absolute Maximum Ratings	22
Performance Curves	23
Typical Radiation Pattern	27
Typical Color Spectrum	28
Mechanical Dimensions	29
Color Binning Information	30
Packaging and Labeling	31
Design Resources	33
Precautions	33
Disclaimers	33
About Bridgelux	34

Product Selection Guide

The following product configurations are available:

Table 1: Selection Guide, Pulsed Measurement Data ($T_j = T_c = 25^\circ\text{C}$)

Part Number	Nominal CCT ¹ (K)	CRI ²	Nominal Drive Current ³ (mA)	Typical Pulsed Flux ^{4,5,6} $T_c = 25^\circ\text{C}$ (lm)	Minimum Pulsed Flux ^{6,7} $T_c = 25^\circ\text{C}$ (lm)	Typical V_f (V)	Typical Power (W)	Typical Efficacy (lm/W)
BXRC-17E4000-B-74-SE	1750	80	900	2725	2452	34.8	31.3	87
BXRC-17E4000-C-74-SE	1750	80	1170	3542	3188	34.8	40.7	87
BXRC-17E4000-D-74-SE	1750	80	1050	2649	2384	29.0	30.5	87
BXRC-20B4001-C-73-SE	2000	65	1170	5985	5387	34.8	40.7	147
BXRC-20B4001-D-73-SE	2000	65	1050	4476	4029	29.0	30.5	147
BXRC-25E4000-B-74-SE	2500	80	900	4416	3975	34.8	31.3	141
BXRC-25E4000-C-74-SE	2500	80	1170	5741	5167	34.8	40.7	141
BXRC-25E4000-D-74-SE	2500	80	1050	4293	3864	29.0	30.5	141
BXRC-27E4000-B-7x-SE	2700	80	900	4729	4256	34.8	31.3	151
BXRC-27E4000-C-7x-SE	2700	80	1170	6148	5533	34.8	40.7	151
BXRC-27E4000-D-7x-SE	2700	80	1050	4598	4138	29.0	30.5	151
BXRC-27G40H0-B-7x-SE	2700	90	900	4072	3664	34.8	31.3	130
BXRC-27G40H0-C-7x-SE	2700	90	1170	5293	4764	34.8	40.7	130
BXRC-27G40H0-D-7x-SE	2700	90	1050	3959	3563	29.0	30.5	130
BXRC-27G4000-B-7x-SE	2700	90	900	3946	3552	34.8	31.3	126
BXRC-27G4000-C-7x-SE	2700	90	1170	5130	4617	34.8	40.7	126
BXRC-27G4000-D-7x-SE	2700	90	1050	3837	3453	29.0	30.5	126
BXRC-27H4000-B-7x-SE	2700	97	900	3414	3072	34.8	31.3	109
BXRC-27H4000-C-7x-SE	2700	97	1170	4438	3994	34.8	40.7	109
BXRC-27H4000-D-7x-SE	2700	97	1050	3319	2987	29.0	30.5	109
BXRC-30C4001-B-74-SE	3000	70	900	5387	4848	34.8	31.3	172
BXRC-30C4001-C-74-SE	3000	70	1170	7003	6303	34.8	40.7	172
BXRC-30C4001-D-74-SE	3000	70	1050	5237	4714	29.0	30.5	172
BXRC-30E4000-B-7x-SE	3000	80	900	4917	4426	34.8	31.3	157
BXRC-30E4000-C-7x-SE	3000	80	1170	6392	5753	34.8	40.7	157
BXRC-30E4000-D-7x-SE	3000	80	1050	4781	4303	29.0	30.5	157
BXRC-30G40H0-B-7x-SE	3000	90	900	4291	3862	34.8	31.3	137
BXRC-30G40H0-C-7x-SE	3000	90	1170	5578	5020	34.8	40.7	137
BXRC-30G40H0-D-7x-SE	3000	90	1050	4172	3754	29.0	30.5	137
BXRC-30G4000-B-7x-SE	3000	90	900	4103	3693	34.8	31.3	131
BXRC-30G4000-C-7x-SE	3000	90	1170	5334	4800	34.8	40.7	131
BXRC-30G4000-D-7x-SE	3000	90	1050	3989	3590	29.0	30.5	131
BXRC-30G400C-B-73-SE	3000	90	900	3790	3411	34.8	31.3	121
BXRC-30G400C-D-73-SE	3000	90	1050	3684	3316	29.0	30.5	121

Notes for Table 1:

- Nominal CCT as defined by ANSI C78.377-2011. Products with a CCT of 5000K-6500K are hot targeted to $T_c = 85^\circ\text{C}$.
- CRI values are typical for Decor Series Ultra, Decor Series Street and Landmark and Decor Series Class A products. CRI values are minimums for all other products. Minimum Rg value for 80 CRI products is 0, the minimum Rg values for 90 CRI products is 50, the minimum Rg values for 97 CRI products is 93. Bridgelux maintains a ± 3 tolerance on CRI and Rg values.
- Drive current is referred to as nominal drive current.
- Products tested under pulsed condition (10ms pulse width) at nominal test current where T_j (junction temperature) - T_c (case temperature) = 25°C .
- Typical performance values are provided as a reference only and are not a guarantee of performance.
- Bridgelux maintains a $\pm 7\%$ tolerance on flux measurements.
- Minimum flux values at the nominal test current are guaranteed by 100% test.
- Nominal CCT is defined by the Lighting Research Center's Class A definition. The center of the Class A color bin is on the corresponding isothermal line.
- GAI value is 80. To help ensure optimal fixture level performance, GAI is measured at the fixture level, on axis, at a case temperature of 70°C . GAI may vary depending on fixture design and performance.

Product Selection Guide

Table 1: Selection Guide, Pulsed Measurement Data ($T_j = T_c = 25^\circ\text{C}$) (continued)

Part Number	Nominal CCT ¹ (K)	CRI ²	Nominal Drive Current ³ (mA)	Typical Pulsed Flux ^{4,5,6} $T_c = 25^\circ\text{C}$ (lm)	Minimum Pulsed Flux ^{6,7} $T_c = 25^\circ\text{C}$ (lm)	Typical V_f (V)	Typical Power (W)	Typical Efficacy (lm/W)
BXRC-30H4000-B-7x-SE	3000	97	900	3664	3298	34.8	31.3	117
BXRC-30H4000-C-7x-SE	3000	97	1170	4764	4287	34.8	40.7	117
BXRC-30H4000-D-7x-SE	3000	97	1050	3563	3206	29.0	30.5	117
BXRC-30A4001-B-73-SE ^{8,9}	3000	93	900	3696	3326	34.8	31.3	118
BXRC-30A4001-C-73-SE ^{8,9}	3000	93	1170	4804	4324	34.8	40.7	118
BXRC-30A4001-D-73-SE ^{8,9}	3000	93	1050	3593	3234	29.0	30.5	118
BXRC-35E4000-B-7x-SE	3500	80	900	5074	4566	34.8	31.3	162
BXRC-35E4000-C-7x-SE	3500	80	1170	6596	5936	34.8	40.7	162
BXRC-35E4000-D-7x-SE	3500	80	1050	4933	4440	29.0	30.5	162
BXRC-35G4000-B-7x-SE	3500	90	900	4228	3805	34.8	31.3	135
BXRC-35G4000-C-7x-SE	3500	90	1170	5497	4947	34.8	40.7	135
BXRC-35G4000-D-7x-SE	3500	90	1050	4111	3700	29.0	30.5	135
BXRC-35A4001-B-73-SE ^{8,9}	3500	93	900	3978	3580	34.8	31.3	127
BXRC-35A4001-C-73-SE ^{8,9}	3500	93	1170	5171	4654	34.8	40.7	127
BXRC-35A4001-D-73-SE ^{8,9}	3500	93	1050	3867	3480	29.0	30.5	127
BXRC-40C4001-B-74-SE	4000	90	900	5544	4989	34.8	31.3	177
BXRC-40C4001-C-74-SE	4000	90	1170	7207	6486	34.8	40.7	177
BXRC-40C4001-D-74-SE	4000	90	1050	5390	4851	29.0	30.5	177
BXRC-40E4000-B-7x-SE	4000	80	900	5105	4595	34.8	31.3	163
BXRC-40E4000-C-7x-SE	4000	80	1170	6637	5973	34.8	40.7	163
BXRC-40E4000-D-7x-SE	4000	80	1050	4963	4467	29.0	30.5	163
BXRC-40G4000-B-7x-SE	4000	90	900	4385	3946	34.8	31.3	140
BXRC-40G4000-C-7x-SE	4000	90	1170	5700	5130	34.8	40.7	140
BXRC-40G4000-D-7x-SE	4000	90	1050	4263	3837	29.0	30.5	140
BXRC-40H4000-B-7x-SE	4000	97	900	3758	3383	34.8	31.3	120
BXRC-40H4000-C-7x-SE	4000	97	1170	4886	4397	34.8	40.7	120
BXRC-40H4000-D-7x-SE	4000	97	1050	3654	3289	29.0	30.5	120
BXRC-40A4001-B-73-SE ^{8,9}	4000	93	900	4260	3834	34.8	31.3	136
BXRC-40A4001-C-73-SE ^{8,9}	4000	93	1170	5537	4984	34.8	40.7	136
BXRC-40A4001-D-73-SE ^{8,9}	4000	93	1050	4141	3727	29.0	30.5	136
BXRC-50C4001-B-7x-SE	5000	70	900	5606	5046	34.8	31.3	179
BXRC-50C4001-C-7x-SE	5000	70	1170	7288	6559	34.8	40.7	179
BXRC-50C4001-D-7x-SE	5000	70	1050	5451	4905	29.0	30.5	179
BXRC-50E4001-B-7x-SE	5000	80	900	5262	4736	34.8	31.3	168
BXRC-50E4001-C-7x-SE	5000	80	1170	6840	6156	34.8	40.7	168
BXRC-50E4001-D-7x-SE	5000	80	1050	5116	4604	29.0	30.5	168

Notes for Table 1:

- Nominal CCT as defined by ANSI C78.377-2011. Products with a CCT of 5000K-6500K are hot targeted to $T_c = 85^\circ\text{C}$.
- CRI values are typical for Decor Series Ultra, Decor Series Street and Landmark and Decor Series Class A products. CRI values are minimums for all other products. Minimum Rg value for 80 CRI products is 0, the minimum Rg values for 90 CRI products is 50, the minimum Rg values for 97 CRI products is 93. Bridgelux maintains a ± 3 tolerance on CRI and Rg values.
- Drive current is referred to as nominal drive current.
- Products tested under pulsed condition (10ms pulse width) at nominal test current where T_j (junction temperature) = T_c (case temperature) = 25°C .
- Typical performance values are provided as a reference only and are not a guarantee of performance.
- Bridgelux maintains a $\pm 7\%$ tolerance on flux measurements.
- Minimum flux values at the nominal test current are guaranteed by 100% test.
- Nominal CCT is defined by the Lighting Research Center's Class A definition. The center of the Class A color bin is on the corresponding isothermal line.
- GAI value is 80. To help ensure optimal fixture level performance, GAI is measured at the fixture level, on axis, at a case temperature of 70°C . GAI may vary depending on fixture design and performance.

Product Selection Guide

Table 1: Selection Guide, Pulsed Measurement Data ($T_j = T_c = 25^\circ\text{C}$) (continued)

Part Number	Nominal CCT ¹ (K)	CRI ²	Nominal Drive Current ³ (mA)	Typical Pulsed Flux ^{4,5,6} $T_c = 25^\circ\text{C}$ (lm)	Minimum Pulsed Flux ^{6,7} $T_c = 25^\circ\text{C}$ (lm)	Typical V_f (V)	Typical Power (W)	Typical Efficacy (lm/W)
BXRC-50G4001-B-7x-SE	5000	90	900	4479	4031	34.8	31.3	143
BXRC-50G4001-C-7x-SE	5000	90	1170	5822	5240	34.8	40.7	143
BXRC-50G4001-D-7x-SE	5000	90	1050	4354	3919	29.0	30.5	143
BXRC-56G4000-B-74-SE	5600	90	900	4698	4228	34.8	31.3	150
BXRC-56G4000-C-74-SE	5600	90	1170	6107	5497	34.8	40.7	150
BXRC-56G4000-D-74-SE	5600	90	1050	4568	4111	29.0	30.5	150
BXRC-56H4000-D-74-SE	5600	97	1050	3959	3563	29.0	30.5	130
BXRC-57C4001-B-7x-SE	5700	70	900	5418	4877	34.8	31.3	173
BXRC-57C4001-C-7x-SE	5700	70	1170	7044	6339	34.8	40.7	173
BXRC-57C4001-D-7x-SE	5700	70	1050	5268	4741	29.0	30.5	173
BXRC-57E4001-B-7x-SE	5700	80	900	5199	4679	34.8	31.3	166
BXRC-57E4001-C-7x-SE	5700	80	1170	6759	6083	34.8	40.7	166
BXRC-57E4001-D-7x-SE	5700	80	1050	5055	4549	29.0	30.5	166
BXRC-65C4001-B-7x-SE	6500	70	900	5512	4961	34.8	31.3	176
BXRC-65C4001-C-7x-SE	6500	70	1170	7166	6449	34.8	40.7	176
BXRC-65C4001-D-7x-SE	6500	70	1050	5359	4823	29.0	30.5	176
BXRC-65E4001-B-7x-SE	6500	80	900	5293	4764	34.8	31.3	169
BXRC-65E4001-C-7x-SE	6500	80	1170	6881	6193	34.8	40.7	169
BXRC-65E4001-D-7x-SE	6500	80	1050	5146	4631	29.0	30.5	169

Notes for Table 1:

- Nominal CCT as defined by ANSI C78.377-2011. Products with a CCT of 5000K-6500K are hot targeted to $T_c = 85^\circ\text{C}$.
- CRI values are typical for Decor Series Ultra, Decor Series Street and Landmark and Decor Series Class A products. CRI values are minimums for all other products. Minimum Rg value for 80 CRI products is 0, the minimum Rg values for 90 CRI products is 50, the minimum Rg values for 97 CRI products is 93. Bridgelux maintains a ± 3 tolerance on CRI and Rg values.
- Drive current is referred to as nominal drive current.
- Products tested under pulsed condition (10ms pulse width) at nominal test current where T_j (junction temperature) - T_c (case temperature) = 25°C .
- Typical performance values are provided as a reference only and are not a guarantee of performance.
- Bridgelux maintains a $\pm 7\%$ tolerance on flux measurements.
- Minimum flux values at the nominal test current are guaranteed by 100% test.
- Nominal CCT is defined by the Lighting Research Center's Class A definition. The center of the Class A color bin is on the corresponding isothermal line.
- GAI value is 80. To help ensure optimal fixture level performance, GAI is measured at the fixture level, on axis, at a case temperature of 70°C . GAI may vary depending on fixture design and performance.

Product Selection Guide

Table 2: Selection Guide, Stabilized DC Performance ($T_c = 70^\circ\text{C}$) ^{7,8}

Part Number	Nominal CCT ¹ (K)	GAI ²	CRI ³	Nominal Drive Current ⁴ (mA)	Typical DC Flux ^{5,6} $T_c = 70^\circ\text{C}$ (lm)	Minimum DC Flux ^{6,9} $T_c = 70^\circ\text{C}$ (lm)	Typical V_f (V)	Typical Power (W)	Typical Efficacy (lm/W)
BXRC-30A4001-B-73-SE	3000	80	93	900	3437	3093	34.3	30.9	111
BXRC-30A4001-C-73-SE	3000	80	93	1170	4468	4021	34.3	40.2	111
BXRC-30A4001-D-73-SE	3000	80	93	1050	3342	3007	28.5	29.9	112
BXRC-35A4001-B-73-SE	3500	80	93	900	3699	3329	34.3	30.9	120
BXRC-35A4001-C-73-SE	3500	80	93	1170	4809	4328	34.3	40.2	120
BXRC-35A4001-D-73-SE	3500	80	93	1050	3596	3237	28.5	29.9	120
BXRC-40A4001-B-73-SE	4000	80	93	900	3961	3565	34.3	30.9	128
BXRC-40A4001-C-73-SE	4000	80	93	1170	5150	4635	34.3	40.2	128
BXRC-40A4001-D-73-SE	4000	80	93	1050	3851	3466	28.5	29.9	129

Notes for Table 2:

- Nominal CCT is defined by the Lighting Research Center's Class A definition. The center of the Class A color bin is on the corresponding isothermal line.
- To help ensure optimal fixture level performance, GAI is measured at the fixture level, on axis, at a case temperature of 70°C . GAI may vary depending on fixture design and performance.
- CRI Values are specified as typical.
- Drive current is referred to as nominal drive current.
- Typical performance values are provided as a reference only and are not a guarantee of performance.
- Bridgelux maintains a $\pm 7\%$ tolerance on flux measurements.
- Typical stabilized DC performance values are provided as reference only and are not a guarantee of performance.
- Typical performance is estimated based on operation under DC (direct current) with LED array mounted onto a heat sink with thermal interface material and the case temperature maintained at specified temperature. Based on Bridgelux test setup, values may vary depending on the thermal design of the luminaire and/or the exposed environment to which the product is subjected.
- Minimum flux values at elevated temperatures are provided for reference only and are not guaranteed by 100% production testing. Based on Bridgelux test setup, values may vary depending on the thermal design of the luminaire and/or the exposed environment to which the product is subjected.

Product Selection Guide

Table 3: Selection Guide, Stabilized DC Performance ($T_c = 85^\circ\text{C}$)^{4,5}

Part Number	Nominal CCT ¹ (K)	CRI ²	Nominal Drive Current ³ (mA)	Typical DC Flux ^{4,5} $T_c = 85^\circ\text{C}$ (lm)	Minimum DC Flux ⁶ $T_c = 85^\circ\text{C}$ (lm)	Typical V_f (V)	Typical Power (W)	Typical Efficacy (lm/W)
BXRC-17E4000-B-74-SE	1750	80	900	2452	2207	33.9	30.5	80
BXRC-17E4000-C-74-SE	1750	80	1170	3188	2869	33.9	39.7	80
BXRC-17E4000-D-74-SE	1750	80	1050	2384	2146	28.3	29.7	80
BXRC-20B4001-C-73-SE	2000	65	1170	5387	4848	34.1	39.9	135
BXRC-20B4001-D-73-SE	2000	65	1050	4029	3626	28.3	29.7	136
BXRC-25E4000-B-74-SE	2500	80	900	3975	3577	33.9	30.5	130
BXRC-25E4000-C-74-SE	2500	80	1170	5167	4650	33.9	39.7	130
BXRC-25E4000-D-74-SE	2500	80	1050	3864	3478	28.3	29.7	130
BXRC-27E4000-B-7x-SE	2700	80	900	4256	3831	33.9	30.5	139
BXRC-27E4000-C-7x-SE	2700	80	1170	5533	4980	33.9	39.7	139
BXRC-27E4000-D-7x-SE	2700	80	1050	4138	3724	28.3	29.7	139
BXRC-27G40H0-B-7x-SE	2700	90	900	3664	3298	33.9	30.5	120
BXRC-27G40H0-C-7x-SE	2700	90	1170	4764	4287	33.9	39.7	120
BXRC-27G40H0-D-7x-SE	2700	90	1050	3563	3206	28.3	29.7	120
BXRC-27G4000-B-7x-SE	2700	90	900	3552	3197	33.9	30.5	116
BXRC-27G4000-C-7x-SE	2700	90	1170	4617	4155	33.9	39.7	116
BXRC-27G4000-D-7x-SE	2700	90	1050	3453	3108	28.3	29.7	116
BXRC-27H4000-B-7x-SE	2700	97	900	3072	2765	33.9	30.5	101
BXRC-27H4000-C-7x-SE	2700	97	1170	3994	3595	33.9	39.7	101
BXRC-27H4000-D-7x-SE	2700	97	1050	2987	2688	28.3	29.7	101
BXRC-30C4001-B-74-SE	3000	70	900	4848	4364	33.9	30.5	159
BXRC-30C4001-C-74-SE	3000	70	1170	6303	5673	33.9	39.7	159
BXRC-30C4001-D-74-SE	3000	70	1050	4714	4242	28.3	29.7	159
BXRC-30E4000-B-7x-SE	3000	80	900	4426	3983	33.9	30.5	145
BXRC-30E4000-C-7x-SE	3000	80	1170	5753	5178	33.9	39.7	145
BXRC-30E4000-D-7x-SE	3000	80	1050	4303	3872	28.3	29.7	145
BXRC-30G40H0-B-7x-SE	3000	90	900	3862	3476	33.9	30.5	127
BXRC-30G40H0-C-7x-SE	3000	90	1170	5020	4518	33.9	39.7	127
BXRC-30G40H0-D-7x-SE	3000	90	1050	3754	3379	28.3	29.7	126
BXRC-30G4000-B-7x-SE	3000	90	900	3693	3323	33.9	30.5	121
BXRC-30G4000-C-7x-SE	3000	90	1170	4800	4320	33.9	39.7	121
BXRC-30G4000-D-7x-SE	3000	90	1050	3590	3231	28.3	29.7	121
BXRC-30G400C-B-73-SE	3000	90	900	3411	3070	33.9	30.5	112
BXRC-30G400C-D-73-SE	3000	90	1050	3316	2984	28.3	29.7	112
BXRC-30H4000-B-7x-SE	3000	97	900	3298	2968	33.9	30.5	108

Notes for Table 3:

- Nominal CCT as defined by ANSI C78.377-2011. Products with a CCT of 5000K-6500K are hot targeted to $T_c = 85^\circ\text{C}$.
- All CRI values are measured at $T_c = 25^\circ\text{C}$. CRI values are typical for Decor Series Ultra, Decor Series Street and Landmark and Decor Series Class A products. CRI values are minimums for all other products. Minimum Rg value for 80 CRI products is 0, the minimum Rg values for 90 CRI products is 50, the minimum Rg values for 97 CRI products is 93. Bridgelux maintains a ± 3 tolerance on CRI and Rg values.
- Drive current is referred to as nominal drive current.
- Typical stabilized DC performance values are provided as reference only and are not a guarantee of performance.
- Typical performance is estimated based on operation under DC (direct current) with LED array mounted onto a heat sink with thermal interface material and the case temperature maintained at 85°C . Based on Bridgelux test setup, values may vary depending on the thermal design of the luminaire and/or the exposed environment to which the product is subjected.
- Minimum flux values at elevated temperatures are provided for reference only and are not guaranteed by 100% production testing. Based on Bridgelux test setup, values may vary depending on the thermal design of the luminaire and/or the exposed environment to which the product is subjected.
- Nominal CCT is defined by the Lighting Research Center's Class A definition. The center of the Class A color bin is on the corresponding isothermal line.
- GAI value is 80. To help ensure optimal fixture level performance, GAI is measured at the fixture level, on axis, at a case temperature of 70°C . GAI may vary depending on fixture design and performance.

Product Selection Guide

Table 3: Selection Guide, Stabilized DC Performance ($T_c = 85^\circ\text{C}$)^{4,5} (continued)

Part Number	Nominal CCT ¹ (K)	CRI ²	Nominal Drive Current ³ (mA)	Typical DC Flux ^{4,5} $T_c = 85^\circ\text{C}$ (lm)	Minimum DC Flux ⁶ $T_c = 85^\circ\text{C}$ (lm)	Typical V_f (V)	Typical Power (W)	Typical Efficacy (lm/W)
BXRC-30H4000-C-7x-SE	3000	97	1170	4287	3859	33.9	39.7	108
BXRC-30H4000-D-7x-SE	3000	97	1050	3206	2886	28.3	29.7	108
BXRC-30A4001-B-73-SE ^{7,8}	3000	93	900	3326	2994	33.9	30.5	109
BXRC-30A4001-C-73-SE ^{7,8}	3000	93	1170	4324	3892	33.9	39.7	109
BXRC-30A4001-D-73-SE ^{7,8}	3000	93	1050	3234	2910	28.3	29.7	109
BXRC-35E4000-B-7x-SE	3500	80	900	4566	4110	33.9	30.5	150
BXRC-35E4000-C-7x-SE	3500	80	1170	5936	5343	33.9	39.7	150
BXRC-35E4000-D-7x-SE	3500	80	1050	4440	3996	28.3	29.7	150
BXRC-35G4000-B-7x-SE	3500	90	900	3805	3425	33.9	30.5	125
BXRC-35G4000-C-7x-SE	3500	90	1170	4947	4452	33.9	39.7	125
BXRC-35G4000-D-7x-SE	3500	90	1050	3700	3330	28.3	29.7	125
BXRC-35A4001-B-73-SE ^{7,8}	3500	93	900	3580	3222	33.9	30.5	117
BXRC-35A4001-C-73-SE ^{7,8}	3500	93	1170	4654	4188	33.9	39.7	117
BXRC-35A4001-D-73-SE ^{7,8}	3500	93	1050	3480	3132	28.3	29.7	117
BXRC-40C4001-B-74-SE	4000	70	900	4989	4490	33.9	30.5	164
BXRC-40C4001-C-74-SE	4000	70	1170	6486	5837	33.9	39.7	164
BXRC-40C4001-D-74-SE	4000	70	1050	4851	4366	28.3	29.7	163
BXRC-40E4000-B-7x-SE	4000	80	900	4595	4135	33.9	30.5	151
BXRC-40E4000-C-7x-SE	4000	80	1170	5973	5376	33.9	39.7	151
BXRC-40E4000-D-7x-SE	4000	80	1050	4467	4020	28.3	29.7	150
BXRC-40G4000-B-7x-SE	4000	90	900	3946	3552	33.9	30.5	129
BXRC-40G4000-C-7x-SE	4000	90	1170	5130	4617	33.9	39.7	129
BXRC-40G4000-D-7x-SE	4000	90	1050	3837	3453	28.3	29.7	129
BXRC-40H4000-B-7x-SE	4000	97	900	3383	3044	33.9	30.5	111
BXRC-40H4000-C-7x-SE	4000	97	1170	4397	3958	33.9	39.7	111
BXRC-40H4000-D-7x-SE	4000	97	1050	3289	2960	28.3	29.7	111
BXRC-40A4001-B-73-SE ^{7,8}	4000	93	900	3834	3450	34.1	30.7	125
BXRC-40A4001-C-73-SE ^{7,8}	4000	93	1170	4984	4485	34.1	39.9	125
BXRC-40A4001-D-73-SE ^{7,8}	4000	93	1050	3727	3354	28.3	29.7	126
BXRC-50C4001-B-7x-SE	5000	70	900	5046	4541	34.1	30.7	165
BXRC-50C4001-C-7x-SE	5000	70	1170	6559	5903	34.1	39.9	165
BXRC-50C4001-D-7x-SE	5000	70	1050	4905	4415	28.3	29.7	165
BXRC-50E4001-B-7x-SE	5000	80	900	4736	4262	34.1	30.7	154
BXRC-50E4001-C-7x-SE	5000	80	1170	6156	5541	34.1	39.9	154
BXRC-50E4001-D-7x-SE	5000	80	1050	4604	4144	28.3	29.7	155

Notes for Table 3:

- Nominal CCT as defined by ANSI C78.377-2011. Products with a CCT of 5000K-6500K are hot targeted to $T_c = 85^\circ\text{C}$.
- All CRI values are measured at $T_a = T_c = 25^\circ\text{C}$. CRI values are typical for Decor Series Ultra, Decor Series Street and Landmark and Decor Series Class A products. CRI values are minimums for all other products. Minimum Rg value for 80 CRI products is 0, the minimum Rg values for 90 CRI products is 50, the minimum Rg values for 97 CRI products is 93. Bridgelux maintains a ± 3 tolerance on CRI and Rg values.
- Drive current is referred to as nominal drive current.
- Typical stabilized DC performance values are provided as reference only and are not a guarantee of performance.
- Typical performance is estimated based on operation under DC (direct current) with LED array mounted onto a heat sink with thermal interface material and the case temperature maintained at 85°C . Based on Bridgelux test setup, values may vary depending on the thermal design of the luminaire and/or the exposed environment to which the product is subjected.
- Minimum flux values at elevated temperatures are provided for reference only and are not guaranteed by 100% production testing. Based on Bridgelux test setup, values may vary depending on the thermal design of the luminaire and/or the exposed environment to which the product is subjected.
- Nominal CCT is defined by the Lighting Research Center's Class A definition. The center of the Class A color bin is on the corresponding isothermal line.
- GAI value is 80. To help ensure optimal fixture level performance, GAI is measured at the fixture level, on axis, at a case temperature of 70°C . GAI may vary depending on fixture design and performance.

Product Selection Guide

Table 3: Selection Guide, Stabilized DC Performance ($T_c = 85^\circ\text{C}$)^{4,5} (continued)

Part Number	Nominal CCT ¹ (K)	CRI ²	Nominal Drive Current ³ (mA)	Typical DC Flux ^{4,5} $T_c = 85^\circ\text{C}$ (lm)	Minimum DC Flux ⁶ $T_c = 85^\circ\text{C}$ (lm)	Typical V_f (V)	Typical Power (W)	Typical Efficacy (lm/W)
BXRC-50G4001-B-7x-SE	5000	90	900	4031	3628	34.1	30.7	131
BXRC-50G4001-C-7x-SE	5000	90	1170	5240	4716	34.1	39.9	131
BXRC-50G4001-D-7x-SE	5000	90	1050	3919	3527	28.3	29.7	132
BXRC-56G4000-B-74-SE	5600	90	900	4228	3805	34.1	30.7	138
BXRC-56G4000-C-74-SE	5600	90	1170	5497	4947	34.1	39.9	138
BXRC-56G4000-D-74-SE	5600	90	1050	4111	3700	28.3	29.7	138
BXRC-56H4000-D-74-SE	5600	97	1050	3563	3206	28.3	29.7	120
BXRC-57C4001-B-7x-SE	5700	80	900	4877	4389	34.1	30.7	159
BXRC-57C4001-C-7x-SE	5700	80	1170	6339	5706	34.1	39.9	159
BXRC-57C4001-D-7x-SE	5700	80	1050	4741	4267	28.3	29.7	160
BXRC-57E4001-B-7x-SE	5700	80	900	4679	4211	34.1	30.7	153
BXRC-57E4001-C-7x-SE	5700	80	1170	6083	5475	34.1	39.9	153
BXRC-57E4001-D-7x-SE	5700	80	1050	4549	4094	28.3	29.7	153
BXRC-65C4001-B-7x-SE	6500	70	900	4961	4465	34.1	30.7	162
BXRC-65C4001-C-7x-SE	6500	70	1170	6449	5804	34.1	39.9	162
BXRC-65C4001-D-7x-SE	6500	70	1050	4823	4341	28.3	29.7	163
BXRC-65E4001-B-7x-SE	6500	80	900	4764	4287	34.1	30.7	155
BXRC-65E4001-C-7x-SE	6500	80	1170	6193	5574	34.1	39.9	155
BXRC-65E4001-D-7x-SE	6500	80	1050	4631	4168	28.3	29.7	156

Notes for Table 3:

- Nominal CCT as defined by ANSI C78.377-2011. Products with a CCT of 5000K-6500K are hot targeted to $T_c = 85^\circ\text{C}$.
- CRI values are typical for Decor Series Ultra, Decor Series Street and Landmark and Decor Series Class A products. CRI values are minimums for all other products. Minimum Rg value for 80 CRI products is 0, the minimum Rg values for 90 CRI products is 50, the minimum Rg values for 97 CRI products is 98. Bridgelux maintains a ± 3 tolerance on CRI and Rg values.
- Drive current is referred to as nominal drive current.
- Typical stabilized DC performance values are provided as reference only and are not a guarantee of performance.
- Typical performance is estimated based on operation under DC (direct current) with LED array mounted onto a heat sink with thermal interface material and the case temperature maintained at 85°C . Based on Bridgelux test setup, values may vary depending on the thermal design of the luminaire and/or the exposed environment to which the product is subjected.
- Minimum flux values at elevated temperatures are provided for reference only and are not guaranteed by 100% production testing. Based on Bridgelux test setup, values may vary depending on the thermal design of the luminaire and/or the exposed environment to which the product is subjected.
- Nominal CCT is defined by the Lighting Research Center's Class A definition. The center of the Class A color bin is on the corresponding isothermal line.
- GAI value is 80. To help ensure optimal fixture level performance, GAI is measured at the fixture level, on axis, at a case temperature of 70°C . GAI may vary depending on fixture design and performance.

Performance at Commonly Used Drive Currents

Vero SE LED arrays are tested to the specifications shown using the nominal drive currents in Table 1. Vero SE may also be driven at other drive currents dependent on specific application design requirements. The performance at any drive current can be derived from the current vs. voltage characteristics shown in Figures 1, 2 & 3 and the flux vs. current characteristics shown in Figures 4, 5 & 6. The performance at commonly used drive currents is summarized in Table 4.

Table 4: Product Performance at Commonly Used Drive Currents

Part Number	CRI	Drive Current ¹ (mA)	Typical V_f $T_c = 25^\circ\text{C}$ (V)	Typical Power $T_c = 25^\circ\text{C}$ (W)	Typical Flux ² $T_c = 25^\circ\text{C}$ (lm)	Typical DC Flux ³ $T_c = 85^\circ\text{C}$ (lm)	Typical Efficacy $T_c = 25^\circ\text{C}$ (lm/W)
BXRC-17E4000-B-74-SE	80	450	33.1	14.9	1463	1315	98
		600	33.8	20.3	1919	1721	95
		900	34.8	31.3	2725	2452	87
		1350	36.5	49.2	4053	3571	82
		1800	37.8	68.1	5215	4533	77
BXRC-17E4000-C-74-SE	80	585	33.2	19.4	1851	1752	95
		780	33.8	26.4	2425	2248	92
		1170	34.8	40.7	3542	3188	87
		1755	36.5	64.1	5096	4485	79
		2340	37.9	88.8	6537	5634	74
BXRC-17E4000-D-74-SE	80	525	27.7	14.6	1411	1310	97
		700	28.2	19.8	1835	1682	93
		1050	29.0	30.5	2649	2384	87
		1575	30.4	47.9	3784	3346	79
		2100	31.5	66.2	4817	4189	73
BXRC-20B4001-C-73-SE	65	585	33.2	19.4	3127	2960	161
		780	33.8	26.4	4098	3798	155
		1170	34.8	40.7	5985	5387	147
		1755	36.5	64.1	8610	7579	134
		2340	37.9	88.8	11045	9519	124
BXRC-20B4001-D-73-SE	65	525	27.7	14.6	2384	2213	164
		700	28.2	19.8	3101	2841	157
		1050	29.0	30.5	4476	4029	147
		1575	30.4	47.9	6394	5654	133
		2100	31.5	66.2	8139	7078	123
BXRC-25E4000-B-74-SE	80	450	33.1	14.9	2371	2131	159
		600	33.8	20.3	3110	2790	154
		900	34.8	31.3	4416	3975	141
		1350	36.5	49.2	6568	5787	133
		1800	37.8	68.1	8452	7347	124
BXRC-25E4000-C-74-SE	80	585	33.2	19.4	3000	2839	155
		780	33.8	26.4	3931	3643	149
		1170	34.8	40.7	5741	5167	141
		1755	36.5	64.1	8259	7269	129
		2340	37.9	88.8	10594	9131	119
BXRC-25E4000-D-74-SE	80	525	27.7	14.6	2287	2123	157
		700	28.2	19.8	2974	2725	151
		1050	29.0	30.5	4293	3864	141
		1575	30.4	47.9	6133	5423	128
		2100	31.5	66.2	7807	6789	118

Notes for Table 4:

1. Alternate drive currents are provided for reference only and are not a guarantee of performance.
2. Bridgelux maintains a $\pm 7\%$ tolerance on flux measurements.
3. Typical stabilized DC performance values are provided as reference only and are not a guarantee of performance.

Performance at Commonly Used Drive Currents

Table 4: Product Performance at Commonly Used Drive Currents (Continued)

Part Number	CRI	Drive Current ¹ (mA)	Typical V _f T _c = 25°C (V)	Typical Power T _c = 25°C (W)	Typical Flux ² T _c = 25°C (lm)	Typical DC Flux ³ T _c = 85°C (lm)	Typical Efficacy T _c = 25°C (lm/W)
BXRC-27E4000-B-7x-SE	80	450	33.1	14.9	2539	2282	170
		600	33.8	20.3	3331	2988	164
		900	34.8	31.3	4729	4256	151
		1350	36.5	49.2	7034	6198	143
		1800	37.8	68.1	9051	7868	133
BXRC-27E4000-C-7x-SE	80	585	33.2	19.4	3212	3040	166
		780	33.8	26.4	4209	3901	160
		1170	34.8	40.7	6148	5533	151
		1755	36.5	64.1	8845	7785	138
		2340	37.9	88.8	11345	9778	128
BXRC-27E4000-D-7x-SE	80	525	27.7	14.6	2449	2273	168
		700	28.2	19.8	3185	2919	161
		1050	29.0	30.5	4598	4138	151
		1575	30.4	47.9	6568	5807	137
		2100	31.5	66.2	8360	7270	126
BXRC-27G40H0-B-7x-SE	90	450	33.1	14.9	2186	1964	147
		600	33.8	20.3	2868	2572	142
		900	34.8	31.3	4072	3664	130
		1350	36.5	49.2	6056	5336	123
		1800	37.8	68.1	7793	6774	115
BXRC-27G40H0-C-7x-SE	90	585	33.2	19.4	2766	2617	142
		780	33.8	26.4	3624	3358	137
		1170	34.8	40.7	5293	4764	130
		1755	36.5	64.1	7615	6702	119
		2340	37.9	88.8	9767	8418	110
BXRC-27G40H0-D-7x-SE	90	525	27.7	14.6	2109	1957	145
		700	28.2	19.8	2742	2513	139
		1050	29.0	30.5	3959	3563	130
		1575	30.4	47.9	5654	5000	118
		2100	31.5	66.2	7198	6259	109
BXRC-27G4000-B-7x-SE	90	450	33.1	14.9	2119	1904	142
		600	33.8	20.3	2779	2493	137
		900	34.8	31.3	3946	3552	126
		1350	36.5	49.2	5869	5171	119
		1800	37.8	68.1	7553	6565	111
BXRC-27G4000-C-7x-SE	90	585	33.2	19.4	2680	2537	138
		780	33.8	26.4	3513	3255	133
		1170	34.8	40.7	5130	4617	126
		1755	36.5	64.1	7380	6496	115
		2340	37.9	88.8	9467	8159	107
BXRC-27G4000-D-7x-SE	90	525	27.7	14.6	2044	1897	140
		700	28.2	19.8	2658	2436	135
		1050	29.0	30.5	3837	3453	126
		1575	30.4	47.9	5480	4846	114
		2100	31.5	66.2	6976	6067	105

Notes for Table 4:

1. Alternate drive currents are provided for reference only and are not a guarantee of performance.
2. Bridgelux maintains a ± 7% tolerance on flux measurements.
3. Typical stabilized DC performance values are provided as reference only and are not a guarantee of performance.

Performance at Commonly Used Drive Currents

Table 4: Product Performance at Commonly Used Drive Currents (Continued)

Part Number	CRI	Drive Current ¹ (mA)	Typical V _f T _c = 25°C (V)	Typical Power T _c = 25°C (W)	Typical Flux ² T _c = 25°C (lm)	Typical DC Flux ³ T _c = 85°C (lm)	Typical Efficacy T _c = 25°C (lm/W)
BXRC-27H4000-B-7x-SE	80	450	33.1	14.9	1833	1647	123
		600	33.8	20.3	2404	2157	119
		900	34.8	31.3	3414	3072	109
		1350	36.5	49.2	5077	4474	103
		1800	37.8	68.1	6534	5680	96
BXRC-27H4000-C-7x-SE	80	585	33.2	19.4	2319	2194	119
		780	33.8	26.4	3039	2816	115
		1170	34.8	40.7	4438	3994	109
		1755	36.5	64.1	6385	5619	100
		2340	37.9	88.8	8190	7059	92
BXRC-27H4000-D-7x-SE	80	525	27.7	14.6	1768	1641	121
		700	28.2	19.8	2299	2107	116
		1050	29.0	30.5	3319	2987	109
		1575	30.4	47.9	4741	4192	99
		2100	31.5	66.2	6035	5248	91
BXRC-30C4001-B-74-SE	70	450	33.1	14.9	2892	2599	194
		600	33.8	20.3	3794	3403	187
		900	34.8	31.3	5387	4848	172
		1350	36.5	49.2	8012	7059	163
		1800	37.8	68.1	10310	8962	151
BXRC-30C4001-C-74-SE	70	585	33.2	19.4	3659	3463	189
		780	33.8	26.4	4795	4443	182
		1170	34.8	40.7	7003	6303	172
		1755	36.5	64.1	10075	8867	157
		2340	37.9	88.8	12923	11138	146
BXRC-30C4001-D-74-SE	70	525	27.7	14.6	2790	2590	192
		700	28.2	19.8	3628	3325	184
		1050	29.0	30.5	5237	4714	172
		1575	30.4	47.9	7481	6615	156
		2100	31.5	66.2	9523	8281	144
BXRC-30E4000-B-7x-SE	80	450	33.1	14.9	2640	2372	177
		600	33.8	20.3	3463	3106	171
		900	34.8	31.3	4917	4426	157
		1350	36.5	49.2	7313	6444	149
		1800	37.8	68.1	9411	8181	138
BXRC-30E4000-C-7x-SE	80	585	33.2	19.4	3340	3161	172
		780	33.8	26.4	4377	4056	166
		1170	34.8	40.7	6392	5753	157
		1755	36.5	64.1	9196	8094	143
		2340	37.9	88.8	11796	10167	133
BXRC-30E4000-D-7x-SE	80	525	27.7	14.6	2547	2364	175
		700	28.2	19.8	3312	3035	168
		1050	29.0	30.5	4781	4303	157
		1575	30.4	47.9	6828	6038	142
		2100	31.5	66.2	8693	7559	131

Notes for Table 4:

1. Alternate drive currents are provided for reference only and are not a guarantee of performance.
2. Bridgelux maintains a ± 7% tolerance on flux measurements.
3. Typical stabilized DC performance values are provided as reference only and are not a guarantee of performance.

Performance at Commonly Used Drive Currents

Table 4: Product Performance at Commonly Used Drive Currents (Continued)

Part Number	CRI	Drive Current ¹ (mA)	Typical V_f $T_c = 25^\circ\text{C}$ (V)	Typical Power $T_c = 25^\circ\text{C}$ (W)	Typical Flux ² $T_c = 25^\circ\text{C}$ (lm)	Typical DC Flux ³ $T_c = 85^\circ\text{C}$ (lm)	Typical Efficacy $T_c = 25^\circ\text{C}$ (lm/W)
BXRC-30G40H0-B-7x-SE	90	450	33.1	14.9	2304	2070	154
		600	33.8	20.3	3022	2711	149
		900	34.8	31.3	4291	3862	137
		1350	36.5	49.2	6382	5623	130
		1800	37.8	68.1	8212	7139	121
BXRC-30G40H0-C-7x-SE	90	585	33.2	19.4	2914	2758	150
		780	33.8	26.4	3819	3539	145
		1170	34.8	40.7	5578	5020	137
		1755	36.5	64.1	8025	7063	125
		2340	37.9	88.8	10293	8872	116
BXRC-30G40H0-D-7x-SE	90	525	27.7	14.6	2222	2063	153
		700	28.2	19.8	2890	2648	146
		1050	29.0	30.5	4172	3754	137
		1575	30.4	47.9	5959	5269	124
		2100	31.5	66.2	7585	6596	115
BXRC-30G4000-B-7x-SE	90	450	33.1	14.9	2203	1979	148
		600	33.8	20.3	2890	2592	143
		900	34.8	31.3	4103	3693	131
		1350	36.5	49.2	6102	5377	124
		1800	37.8	68.1	7853	6826	115
BXRC-30G4000-C-7x-SE	90	585	33.2	19.4	2787	2637	144
		780	33.8	26.4	3652	3384	139
		1170	34.8	40.7	5334	4800	131
		1755	36.5	64.1	7673	6754	120
		2340	37.9	88.8	9843	8483	111
BXRC-30G4000-D-7x-SE	90	525	27.7	14.6	2125	1972	146
		700	28.2	19.8	2763	2532	140
		1050	29.0	30.5	3989	3590	131
		1575	30.4	47.9	5698	5038	119
		2100	31.5	66.2	7253	6307	110
BXRC-30G400C-B-73-SE	90	450	33.1	14.9	2035	1828	136
		600	33.8	20.3	2669	2394	132
		900	34.8	31.3	3790	3411	121
		1350	36.5	49.2	5636	4966	115
		1800	37.8	68.1	7253	6305	107
BXRC-30G400C-D-73-SE	90	525	27.7	14.6	1963	1822	135
		700	28.2	19.8	2552	2339	129
		1050	29.0	30.5	3684	3316	121
		1575	30.4	47.9	5263	4654	110
		2100	31.5	66.2	6699	5826	101
BXRC-30H4000-B-7x-SE	80	450	33.1	14.9	1967	1768	132
		600	33.8	20.3	2581	2315	127
		900	34.8	31.3	3664	3298	117
		1350	36.5	49.2	5450	4802	111
		1800	37.8	68.1	7013	6097	103

Notes for Table 4:

1. Alternate drive currents are provided for reference only and are not a guarantee of performance.
2. Bridgelux maintains a $\pm 7\%$ tolerance on flux measurements.
3. Typical stabilized DC performance values are provided as reference only and are not a guarantee of performance.

Performance at Commonly Used Drive Currents

Table 4: Product Performance at Commonly Used Drive Currents (Continued)

Part Number	CRI	Drive Current ¹ (mA)	Typical V _f T _c = 25°C (V)	Typical Power T _c = 25°C (W)	Typical Flux ² T _c = 25°C (lm)	Typical DC Flux ³ T _c = 85°C (lm)	Typical Efficacy T _c = 25°C (lm/W)
BXRC-30H4000-C-7x-SE	80	585	33.2	19.4	2489	2356	128
		780	33.8	26.4	3262	3023	124
		1170	34.8	40.7	4764	4287	117
		1755	36.5	64.1	6853	6032	107
		2340	37.9	88.8	8791	7577	99
BXRC-30H4000-D-7x-SE	80	525	27.7	14.6	1898	1762	130
		700	28.2	19.8	2468	2262	125
		1050	29.0	30.5	3563	3206	117
		1575	30.4	47.9	5089	4500	106
		2100	31.5	66.2	6478	5633	98
BXRC-30A4001-B-73-SE	93	450	33.1	14.9	1984	1783	133
		600	33.8	20.3	2603	2335	129
		900	34.8	31.3	3696	3326	118
		1350	36.5	49.2	5497	4843	112
		1800	37.8	68.1	7073	6149	104
BXRC-30A4001-C-73-SE	93	585	33.2	19.4	2510	2376	129
		780	33.8	26.4	3290	3048	125
		1170	34.8	40.7	4804	4324	118
		1755	36.5	64.1	6912	6083	108
		2340	37.9	88.8	8866	7641	100
BXRC-30A4001-D-73-SE	93	525	27.7	14.6	1914	1777	131
		700	28.2	19.8	2489	2281	126
		1050	29.0	30.5	3593	3234	118
		1575	30.4	47.9	5132	4538	107
		2100	31.5	66.2	6533	5681	99
BXRC-35E4000-B-7x-SE	80	450	33.1	14.9	2724	2448	183
		600	33.8	20.3	3574	3205	176
		900	34.8	31.3	5074	4566	162
		1350	36.5	49.2	7546	6649	153
		1800	37.8	68.1	9711	8441	143
BXRC-35E4000-C-7x-SE	80	585	33.2	19.4	3446	3261	178
		780	33.8	26.4	4516	4185	171
		1170	34.8	40.7	6596	5936	162
		1755	36.5	64.1	9489	8352	148
		2340	37.9	88.8	12172	10491	137
BXRC-35E4000-D-7x-SE	80	525	27.7	14.6	2628	2439	180
		700	28.2	19.8	3417	3131	173
		1050	29.0	30.5	4933	4440	162
		1575	30.4	47.9	7046	6230	147
		2100	31.5	66.2	8969	7800	135
BXRC-35G4000-B-7x-SE	90	450	33.1	14.9	2270	2040	152
		600	33.8	20.3	2978	2671	147
		900	34.8	31.3	4228	3805	135
		1350	36.5	49.2	6289	5541	128
		1800	37.8	68.1	8092	7034	119

Notes for Table 4:

1. Alternate drive currents are provided for reference only and are not a guarantee of performance.
2. Bridgelux maintains a ± 7% tolerance on flux measurements.
3. Typical stabilized DC performance values are provided as reference only and are not a guarantee of performance.

Performance at Commonly Used Drive Currents

Table 4: Product Performance at Commonly Used Drive Currents (Continued)

Part Number	CRI	Drive Current ¹ (mA)	Typical V _f T _c = 25°C (V)	Typical Power T _c = 25°C (W)	Typical Flux ² T _c = 25°C (lm)	Typical DC Flux ³ T _c = 85°C (lm)	Typical Efficacy T _c = 25°C (lm/W)
BXRC-35G4000-C-7x-SE	90	585	33.2	19.4	2872	2718	148
		780	33.8	26.4	3763	3488	143
		1170	34.8	40.7	5497	4947	135
		1755	36.5	64.1	7907	6960	123
		2340	37.9	88.8	10143	8742	114
BXRC-35G4000-D-7x-SE	90	525	27.7	14.6	2190	2033	150
		700	28.2	19.8	2848	2610	144
		1050	29.0	30.5	4111	3700	135
		1575	30.4	47.9	5872	5192	123
		2100	31.5	66.2	7475	6500	113
BXRC-35A4001-B-73-SE	93	450	33.1	14.9	2136	1919	143
		600	33.8	20.3	2801	2513	138
		900	34.8	31.3	3978	3580	127
		1350	36.5	49.2	5916	5212	120
		1800	37.8	68.1	7613	6618	112
BXRC-35A4001-C-73-SE	93	585	33.2	19.4	2702	2557	139
		780	33.8	26.4	3540	3281	134
		1170	34.8	40.7	5171	4654	127
		1755	36.5	64.1	7439	6547	116
		2340	37.9	88.8	9542	8224	108
BXRC-35A4001-D-73-SE	93	525	27.7	14.6	2060	1912	141
		700	28.2	19.8	2679	2455	136
		1050	29.0	30.5	3867	3480	127
		1575	30.4	47.9	5524	4884	115
		2100	31.5	66.2	7032	6115	106
BXRC-40C4001-B-74-SE	70	450	33.1	14.9	2976	2675	200
		600	33.8	20.3	3904	3502	193
		900	34.8	31.3	5544	4989	177
		1350	36.5	49.2	8245	7265	168
		1800	37.8	68.1	10610	9223	156
BXRC-40C4001-C-74-SE	70	585	33.2	19.4	3765	3563	194
		780	33.8	26.4	4934	4573	187
		1170	34.8	40.7	7207	6486	177
		1755	36.5	64.1	10368	9125	162
		2340	37.9	88.8	13299	11462	150
BXRC-40C4001-D-74-SE	70	525	27.7	14.6	2871	2665	197
		700	28.2	19.8	3733	3421	189
		1050	29.0	30.5	5390	4851	177
		1575	30.4	47.9	7698	6807	161
		2100	31.5	66.2	9800	8522	148
BXRC-40E4000-B-7x-SE	80	450	33.1	14.9	2741	2463	184
		600	33.8	20.3	3596	3225	178
		900	34.8	31.3	5105	4595	163
		1350	36.5	49.2	7593	6690	154
		1800	37.8	68.1	9771	8493	144

Notes for Table 4:

1. Alternate drive currents are provided for reference only and are not a guarantee of performance.
2. Bridgelux maintains a ± 7% tolerance on flux measurements.
3. Typical stabilized DC performance values are provided as reference only and are not a guarantee of performance.

Performance at Commonly Used Drive Currents

Table 4: Product Performance at Commonly Used Drive Currents (Continued)

Part Number	CRI	Drive Current ¹ (mA)	Typical V _f T _c = 25°C (V)	Typical Power T _c = 25°C (W)	Typical Flux ² T _c = 25°C (lm)	Typical DC Flux ³ T _c = 85°C (lm)	Typical Efficacy T _c = 25°C (lm/W)
BXRC-40E4000-C-7x-SE	80	585	33.2	19.4	3468	3282	179
		780	33.8	26.4	4544	4211	172
		1170	34.8	40.7	6637	5973	163
		1755	36.5	64.1	9548	8403	149
		2340	37.9	88.8	12247	10555	138
BXRC-40E4000-D-7x-SE	80	525	27.7	14.6	2644	2454	182
		700	28.2	19.8	3438	3151	174
		1050	29.0	30.5	4963	4467	163
		1575	30.4	47.9	7089	6269	148
		2100	31.5	66.2	9025	7848	136
BXRC-40G4000-B-7x-SE	90	450	33.1	14.9	2354	2115	158
		600	33.8	20.3	3088	2770	152
		900	34.8	31.3	4385	3946	140
		1350	36.5	49.2	6522	5746	133
		1800	37.8	68.1	8392	7295	123
BXRC-40G4000-C-7x-SE	90	585	33.2	19.4	2978	2819	153
		780	33.8	26.4	3903	3617	148
		1170	34.8	40.7	5700	5130	140
		1755	36.5	64.1	8200	7218	128
		2340	37.9	88.8	10519	9066	119
BXRC-40G4000-D-7x-SE	90	525	27.7	14.6	2271	2108	156
		700	28.2	19.8	2953	2706	149
		1050	29.0	30.5	4263	3837	140
		1575	30.4	47.9	6089	5384	127
		2100	31.5	66.2	7751	6741	117
BXRC-40H4000-B-7x-SE	97	450	33.1	14.9	2018	1813	135
		600	33.8	20.3	2647	2374	131
		900	34.8	31.3	3758	3383	120
		1350	36.5	49.2	5590	4925	114
		1800	37.8	68.1	7193	6253	106
BXRC-40H4000-C-7x-SE	97	585	33.2	19.4	2553	2416	132
		780	33.8	26.4	3345	3100	127
		1170	34.8	40.7	4886	4397	120
		1755	36.5	64.1	7029	6187	110
		2340	37.9	88.8	9016	7771	102
BXRC-40H4000-D-7x-SE	97	525	27.7	14.6	1947	1807	134
		700	28.2	19.8	2531	2320	128
		1050	29.0	30.5	3654	3289	120
		1575	30.4	47.9	5219	4615	109
		2100	31.5	66.2	6644	5778	100
BXRC-40A4001-B-73-SE	93	450	33.1	14.9	2287	2055	153
		600	33.8	20.3	3000	2691	148
		900	34.8	31.3	4260	3834	136
		1350	36.5	49.2	6335	5582	129
		1800	37.8	68.1	8152	7087	120

Notes for Table 4:

1. Alternate drive currents are provided for reference only and are not a guarantee of performance.
2. Bridgelux maintains a ± 7% tolerance on flux measurements.
3. Typical stabilized DC performance values are provided as reference only and are not a guarantee of performance.

Performance at Commonly Used Drive Currents

Table 4: Product Performance at Commonly Used Drive Currents (Continued)

Part Number	CRI	Drive Current ¹ (mA)	Typical V _f T _c = 25°C (V)	Typical Power T _c = 25°C (W)	Typical Flux ² T _c = 25°C (lm)	Typical DC Flux ³ T _c = 85°C (lm)	Typical Efficacy T _c = 25°C (lm/W)
BXRC-40A4001-C-73-SE	93	585	33.2	19.4	2893	2738	149
		780	33.8	26.4	3791	3513	144
		1170	34.8	40.7	5537	4984	136
		1755	36.5	64.1	7966	7011	124
		2340	37.9	88.8	10218	8807	115
BXRC-40A4001-D-73-SE	93	525	27.7	14.6	2206	2048	152
		700	28.2	19.8	2869	2629	145
		1050	29.0	30.5	4141	3727	136
		1575	30.4	47.9	5915	5231	123
		2100	31.5	66.2	7530	6548	114
BXRC-50C4001-B-7x-SE	70	450	33.1	14.9	3010	2705	202
		600	33.8	20.3	3949	3541	195
		900	34.8	31.3	5606	5046	179
		1350	36.5	49.2	8338	7347	169
		1800	37.8	68.1	10730	9327	158
BXRC-50C4001-C-7x-SE	70	585	33.2	19.4	3808	3604	196
		780	33.8	26.4	4990	4624	189
		1170	34.8	40.7	7288	6559	179
		1755	36.5	64.1	10485	9228	163
		2340	37.9	88.8	13449	11592	152
BXRC-50C4001-D-7x-SE	70	525	27.7	14.6	2904	2695	199
		700	28.2	19.8	3776	3460	191
		1050	29.0	30.5	5451	4905	179
		1575	30.4	47.9	7785	6884	162
		2100	31.5	66.2	9911	8618	150
BXRC-50E4001-B-7x-SE	80	450	33.1	14.9	2825	2539	189
		600	33.8	20.3	3706	3324	183
		900	34.8	31.3	5262	4736	168
		1350	36.5	49.2	7826	6895	159
		1800	37.8	68.1	10070	8754	148
BXRC-50E4001-C-7x-SE	80	585	33.2	19.4	3574	3382	184
		780	33.8	26.4	4683	4340	178
		1170	34.8	40.7	6840	6156	168
		1755	36.5	64.1	9840	8661	153
		2340	37.9	88.8	12623	10879	142
BXRC-50E4001-D-7x-SE	80	525	27.7	14.6	2725	2529	187
		700	28.2	19.8	3544	3247	179
		1050	29.0	30.5	5116	4604	168
		1575	30.4	47.9	7307	6461	152
		2100	31.5	66.2	9302	8089	140
BXRC-50G4001-B-7x-SE	90	450	33.1	14.9	2405	2161	161
		600	33.8	20.3	3154	2829	156
		900	34.8	31.3	4479	4031	143
		1350	36.5	49.2	6661	5869	135
		1800	37.8	68.1	8572	7451	126

Notes for Table 4:

1. Alternate drive currents are provided for reference only and are not a guarantee of performance.
2. Bridgelux maintains a ± 7% tolerance on flux measurements.
3. Typical stabilized DC performance values are provided as reference only and are not a guarantee of performance.

Performance at Commonly Used Drive Currents

Table 4: Product Performance at Commonly Used Drive Currents (Continued)

Part Number	CRI	Drive Current ¹ (mA)	Typical V _f T _c = 25°C (V)	Typical Power T _c = 25°C (W)	Typical Flux ² T _c = 25°C (lm)	Typical DC Flux ³ T _c = 85°C (lm)	Typical Efficacy T _c = 25°C (lm/W)
BXRC-50G4001-C-7x-SE	90	585	33.2	19.4	3042	2879	157
		780	33.8	26.4	3986	3694	151
		1170	34.8	40.7	5822	5240	143
		1755	36.5	64.1	8376	7372	131
		2340	37.9	88.8	10744	9260	121
BXRC-50G4001-D-7x-SE	90	525	27.7	14.6	2320	2153	159
		700	28.2	19.8	3016	2764	153
		1050	29.0	30.5	4354	3919	143
		1575	30.4	47.9	6220	5500	130
		2100	31.5	66.2	7918	6885	120
BXRC-56G4000-B-74-SE	80	450	33.1	14.9	2522	2267	169
		600	33.8	20.3	3309	2968	163
		900	34.8	31.3	4698	4228	150
		1350	36.5	49.2	6987	6156	142
		1800	37.8	68.1	8992	7816	132
BXRC-56G4000-C-74-SE	80	585	33.2	19.4	3191	3020	164
		780	33.8	26.4	4182	3875	159
		1170	34.8	40.7	6107	5497	150
		1755	36.5	64.1	8786	7733	137
		2340	37.9	88.8	11270	9714	127
BXRC-56G400x-D-74-SE	80	525	27.7	14.6	2433	2258	167
		700	28.2	19.8	3164	2899	160
		1050	29.0	30.5	4568	4111	150
		1575	30.4	47.9	6524	5769	136
		2100	31.5	66.2	8305	7222	125
BXRC-56H4000-D-74-SE	97	525	27.7	14.6	2109	1957	145
		700	28.2	19.8	2742	2513	139
		1050	29.0	30.5	3959	3563	130
		1575	30.4	47.9	5654	5000	118
		2100	31.5	66.2	7198	6259	109
BXRC-57C4001-B-7x-SE	70	450	33.1	14.9	2909	2614	195
		600	33.8	20.3	3816	3423	188
		900	34.8	31.3	5418	4877	173
		1350	36.5	49.2	8059	7100	164
		1800	37.8	68.1	10370	9015	152
BXRC-57C4001-C-7x-SE	70	585	33.2	19.4	3680	3483	190
		780	33.8	26.4	4823	4469	183
		1170	34.8	40.7	7044	6339	173
		1755	36.5	64.1	10133	8919	158
		2340	37.9	88.8	12998	11203	146
BXRC-57C4001-D-7x-SE	70	525	27.7	14.6	2806	2605	193
		700	28.2	19.8	3649	3344	185
		1050	29.0	30.5	5268	4741	173
		1575	30.4	47.9	7524	6654	157
		2100	31.5	66.2	9579	8330	145

Notes for Table 4:

1. Alternate drive currents are provided for reference only and are not a guarantee of performance.
2. Bridgelux maintains a ± 7% tolerance on flux measurements.
3. Typical stabilized DC performance values are provided as reference only and are not a guarantee of performance.

Performance at Commonly Used Drive Currents

Table 4: Product Performance at Commonly Used Drive Currents (Continued)

Part Number	CRI	Drive Current ¹ (mA)	Typical V _f T _c = 25°C (V)	Typical Power T _c = 25°C (W)	Typical Flux ² T _c = 25°C (lm)	Typical DC Flux ³ T _c = 85°C (lm)	Typical Efficacy T _c = 25°C (lm/W)
BXRC-57E4001-B-7x-SE	80	450	33.1	14.9	2791	2508	187
		600	33.8	20.3	3662	3284	181
		900	34.8	31.3	5199	4679	166
		1350	36.5	49.2	7733	6813	157
		1800	37.8	68.1	9951	8650	146
BXRC-57E4001-C-7x-SE	80	585	33.2	19.4	3531	3342	182
		780	33.8	26.4	4628	4288	176
		1170	34.8	40.7	6759	6083	166
		1755	36.5	64.1	9723	8558	152
		2340	37.9	88.8	12472	10750	141
BXRC-57E4001-D-7x-SE	80	525	27.7	14.6	2693	2499	185
		700	28.2	19.8	3501	3209	177
		1050	29.0	30.5	5055	4549	166
		1575	30.4	47.9	7220	6384	151
		2100	31.5	66.2	9191	7992	139
BXRC-65C4001-B-7x-SE	70	450	33.1	14.9	2960	2659	198
		600	33.8	20.3	3882	3482	192
		900	34.8	31.3	5512	4961	176
		1350	36.5	49.2	8198	7224	167
		1800	37.8	68.1	10550	9171	155
BXRC-65C4001-C-7x-SE	70	585	33.2	19.4	3744	3543	193
		780	33.8	26.4	4906	4547	186
		1170	34.8	40.7	7166	6449	176
		1755	36.5	64.1	10309	9074	161
		2340	37.9	88.8	13224	11397	149
BXRC-65C4001-D-7x-SE	70	525	27.7	14.6	2855	2650	196
		700	28.2	19.8	3712	3402	188
		1050	29.0	30.5	5359	4823	176
		1575	30.4	47.9	7655	6769	160
		2100	31.5	66.2	9745	8474	147
BXRC-65E4001-B-7x-SE	80	450	33.1	14.9	2842	2554	191
		600	33.8	20.3	3728	3344	184
		900	34.8	31.3	5293	4764	169
		1350	36.5	49.2	7872	6936	160
		1800	37.8	68.1	10130	8806	149
BXRC-65E4001-C-7x-SE	80	585	33.2	19.4	3595	3402	185
		780	33.8	26.4	4711	4366	179
		1170	34.8	40.7	6881	6193	169
		1755	36.5	64.1	9899	8713	154
		2340	37.9	88.8	12698	10944	143
BXRC-65E4001-D-7x-SE	80	525	27.7	14.6	2741	2544	188
		700	28.2	19.8	3565	3267	180
		1050	29.0	30.5	5146	4631	169
		1575	30.4	47.9	7350	6500	153
		2100	31.5	66.2	9357	8137	141

Notes for Table 4:

1. Alternate drive currents are provided for reference only and are not a guarantee of performance.
2. Bridgelux maintains a ± 7% tolerance on flux measurements.
3. Typical stabilized DC performance values are provided as reference only and are not a guarantee of performance.

Electrical Characteristics

Table 5: Electrical Characteristics

Part Number	Drive Current (mA)	Forward Voltage Pulsed, $T_c = 25^\circ\text{C}$ (V) ^{1, 2, 3, 8}			Typical Coefficient of Forward Voltage ⁴ $\Delta V_f / \Delta T_c$ (mV/ $^\circ\text{C}$)	Typical Thermal Resistance Junction to Case ^{5,6} R_{j-c} ($^\circ\text{C}/\text{W}$)	Driver Selection Voltages ⁷ (V)	
		Minimum	Typical	Maximum			V_f Min. Hot $T_c = 105^\circ\text{C}$ (V)	V_f Max. Cold $T_c = -40^\circ\text{C}$ (V)
BXRC-xxx400x-B-7x-SE	900	32.2	34.8	37.4	-14.9	0.15	31.0	38.4
	1800	35.0	37.8	40.6	-14.9	0.19	33.8	41.6
BXRC-xxx400x-C-7x-SE	1170	32.2	34.8	37.4	-14.9	0.11	31.0	38.4
	2340	35.0	37.8	40.6	-14.9	0.13	33.8	41.6
BXRC-xxx400x-D-7x-SE	1050	26.8	29.0	31.2	-12.2	0.16	25.8	32.0
	2100	29.2	31.5	33.9	-12.2	0.19	28.2	34.7

Notes for Table 5:

- Parts are tested in pulsed conditions. $T_c = 25^\circ\text{C}$. Pulse width is 10ms.
- Voltage minimum and maximum are provided for reference only and are not a guarantee of performance.
- Bridgelux maintains a tester tolerance of $\pm 0.10\text{V}$ on forward voltage measurements.
- Typical coefficient of forward voltage tolerance is $\pm 0.1\text{mV}$ for nominal current.
- Thermal resistance values are based from test data of a 3000K 80 CRI product.
- Thermal resistance value was calculated using total electrical input power; optical power was not subtracted from input power. The thermal interface material used during testing is not included in the thermal resistance value.
- V_f min hot and max cold values are provided as reference only and are not guaranteed by test. These values are provided to aid in driver design and selection over the operating range of the product.
- This product has been designed and manufactured per IEC 62031:2014. This product has passed dielectric withstand voltage testing at 1160 V. The working voltage designated for the insulation is 80V d.c. The maximum allowable voltage across the array must be determined in the end product application.

Eye Safety

Table 6: Eye Safety Risk Group (RG) Classifications

Part Number	Drive Current ⁵ (mA)	CCT ⁵			
		2700K/3000K	4000K ²	5000K ³	6500K ⁴
BXRC-xxx400x-B-7x-SE	900	RG1	RG1	RG1	RG1
	1350	RG1	RG1	RG1	RG2
	1800	RG1	RG1	RG2	RG2
BXRC-xxx400x-C-7x-SE	1170	RG1	RG1	RG1	RG1
	1755	RG1	RG1	RG2	RG2
	2340	RG1	RG1	RG2	RG2
BXRC-xxx400x-D-7x-SE	1050	RG1	RG1	RG1	RG1
	1575	RG1	RG1	RG1	RG2
	2100	RG1	RG1	RG2	RG2

Notes for Table 6:

1. Eye safety classification for the use of Bridgelux Vero SE Series LED arrays is in accordance with specification IEC/TR 62778: Application of IEC 62471 for the assessment of blue light hazard to light sources and luminaires.
2. For products classified as RG2 at 4000K, $E_{thr} = 1847.5$ lx.
3. For products classified as RG2 at 5000K $E_{thr} = 1315.8$ lx.
4. For products classified as RG2 at 6500K, $E_{thr} = 1124.5$ lx.
5. Please contact your Bridgelux sales representative for E_{thr} values at specific drive currents and CCTs not listed.

Absolute Maximum Ratings

Table 7: Maximum Ratings

Parameter	Maximum Rating		
LED Junction Temperature (T_j)	150°C		
Storage Temperature	-40°C to +105°C		
Operating Case Temperature ¹ (T_c)	105°C		
	BXRC-xxx400x-B-7x-SE	BXRC-xxx400x-C-7x-SE	BXRC-xxx400x-D-7x-SE
Maximum Drive Current ³	1800mA	2340mA	2100mA
Maximum Peak Pulsed Drive Current ⁴	2570mA	3340mA	3000mA
Maximum Reverse Voltage ⁵	-60V	-60V	-50V

Notes for Table 7:

1. For IEC 62717 requirement, please consult your Bridgelux sales representative.
2. Refer to Bridgelux Application Note AN120: Assembly Considerations for Bridgelux Vero SE LED Arrays.
3. Arrays may be driven at higher currents however lumen maintenance may be reduced.
4. Bridgelux recommends a maximum duty cycle of 10% and pulse width of 20 ms when operating LED Arrays at maximum peak pulsed current specified. Maximum peak pulsed currents indicate values where LED Arrays can be driven without catastrophic failures.
5. Light emitting diodes are not designed to be driven in reverse voltage and will not produce light under this condition. Maximum rating provided for reference only.

Performance Curves

Figure 1: Vero SE 18B Drive Current vs. Voltage

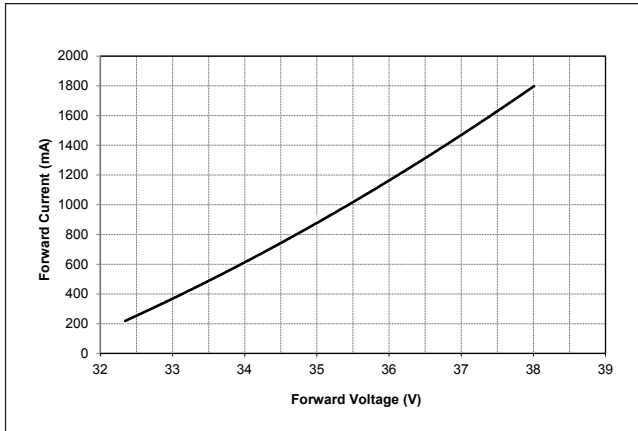

Figure 2: Vero SE 18C Drive Current vs. Voltage

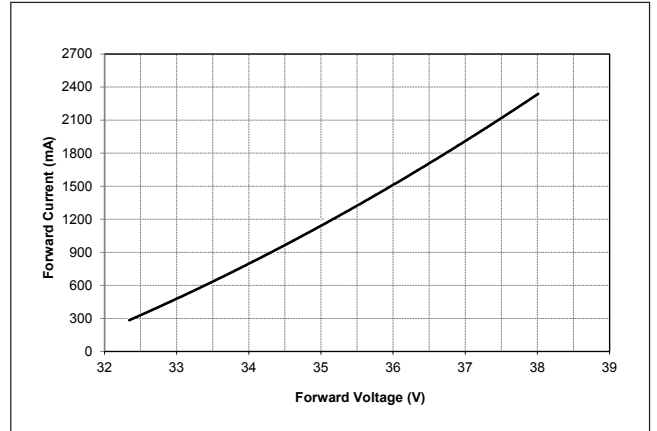

Figure 3: Vero SE 18D Drive Current vs. Voltage

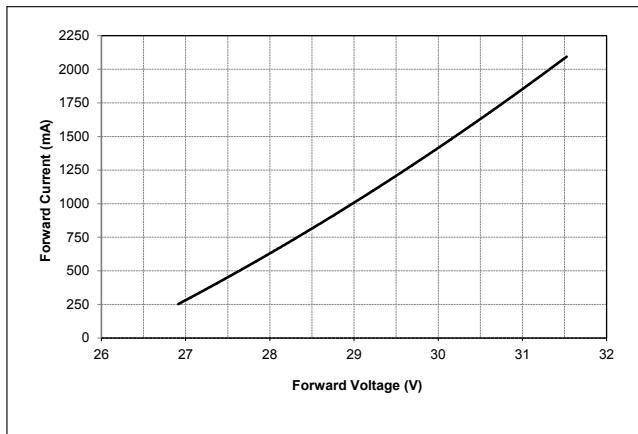

Figure 4: Vero SE 18B Typical Relative Flux vs. Current

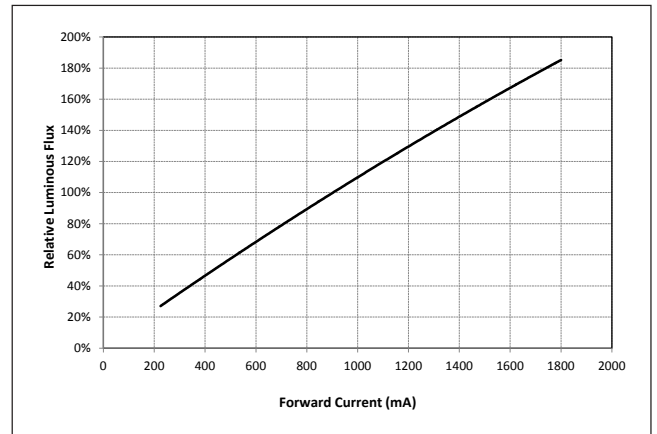

Figure 5: Vero SE 18C Typical Relative Flux vs. Current

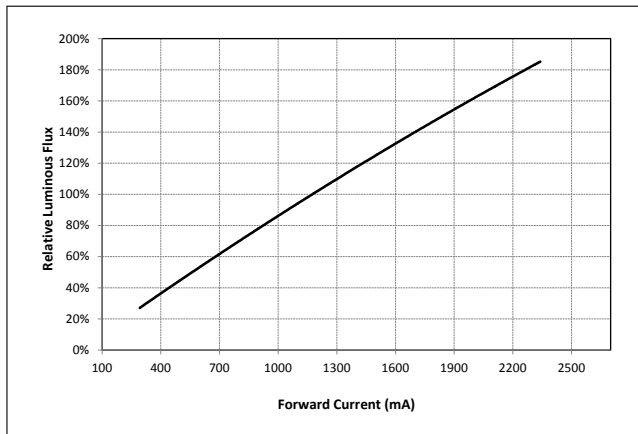
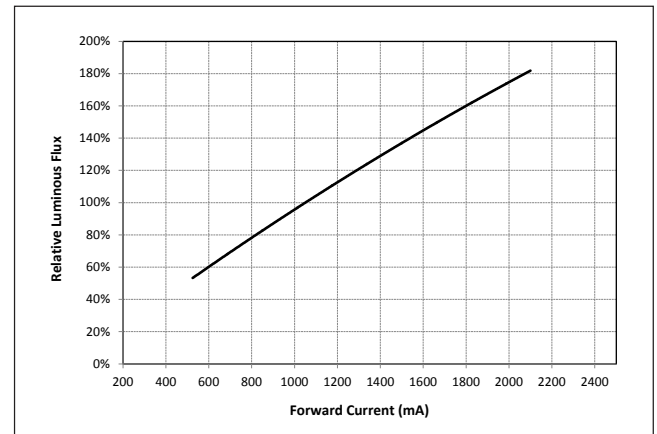

Figure 6: Vero SE 18D Typical Relative Flux vs. Current



Notes for Figures 1-6:

1. Bridgelux does not recommend driving high power LEDs at low currents. Doing so may produce unpredictable results. Pulse width modulation (PWM) is recommended for dimming effects.
2. Products tested under pulsed condition (10ms pulse width) at nominal test current where T_j (junction temperature) = T_c (case temperature) = 25°C.

Performance Curves

Figure 7: Typical DC Flux vs. Case Temperature

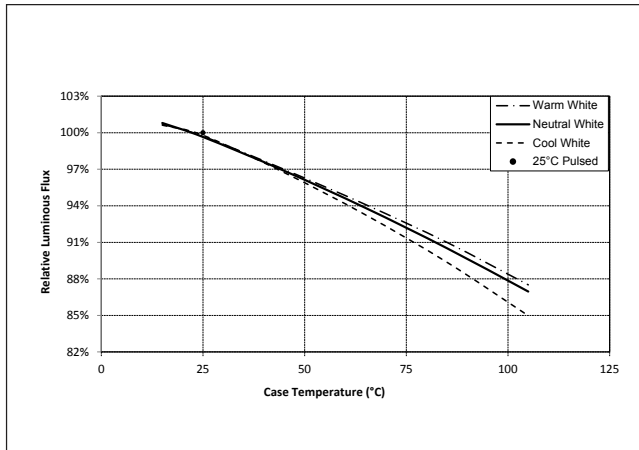

Figure 8: Typical DC ccy Shift vs. Case Temperature

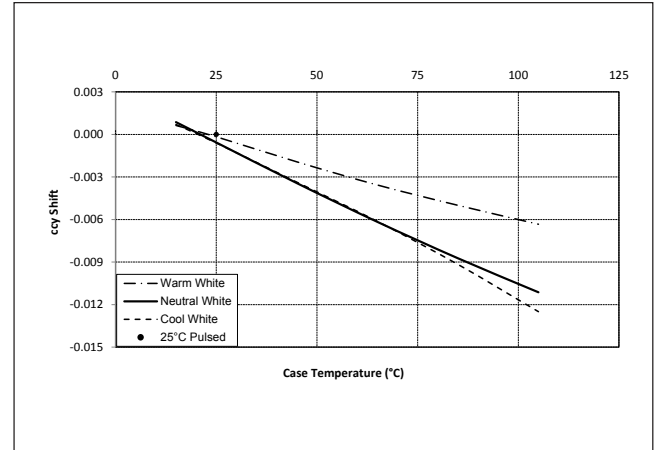
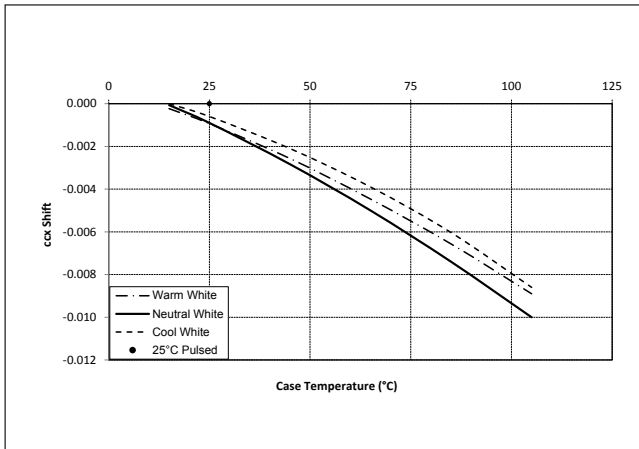

Figure 9: Typical DC ccx Shift vs. Case Temperature



Notes for Figures 7-9:

1. Characteristics shown for warm white based on 3000K and 80 CRI.
2. Characteristics shown for neutral white based on 4000K and 80 CRI.
3. Characteristics shown for cool white based on 5000K and 70 CRI.
4. For other color SKUs, the shift in color will vary. Please contact your Bridgelux Sales Representative for more information.

Performance Curves

Figure 10: 1750K Color Shift vs. Case Temperature¹

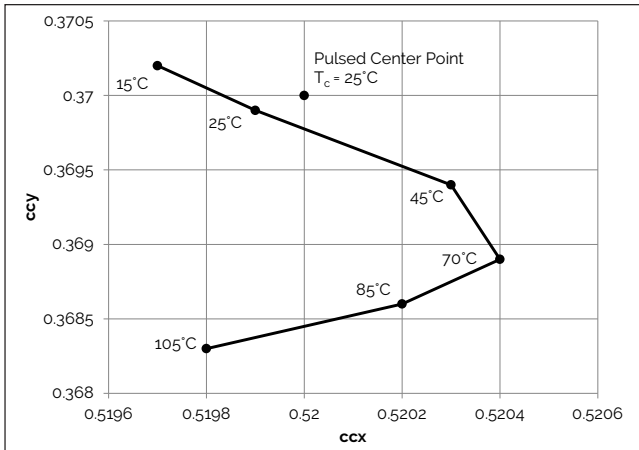

Figure 11: 2000K, 65 CRI Color Shift vs. Case Temperature¹

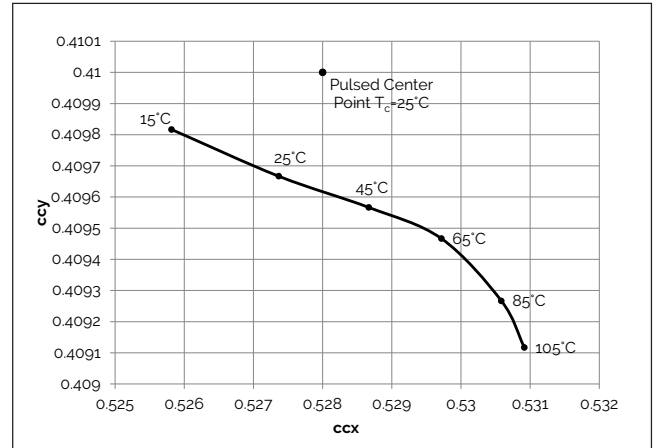

Figure 12: 2500K Color Shift vs. Case Temperature¹

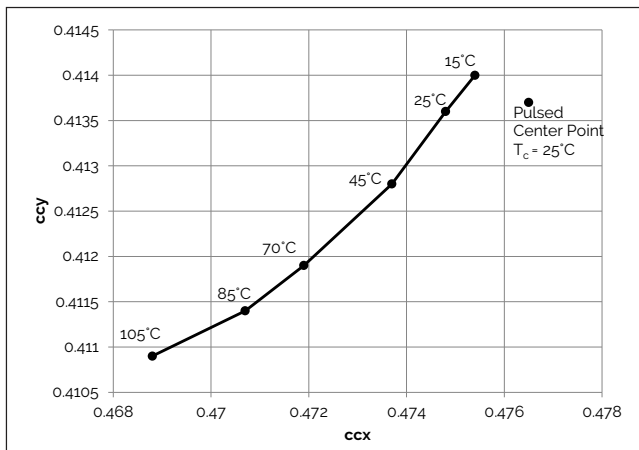

Figure 13: 3000K, 90 CRI Color Shift vs. Case Temperature^{1,3,4}

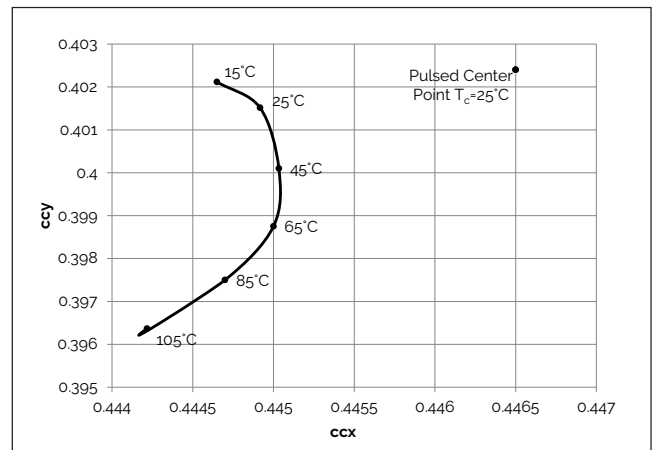

Figure 14: 2700K, 97 CRI Color Shift vs. Case Temperature¹

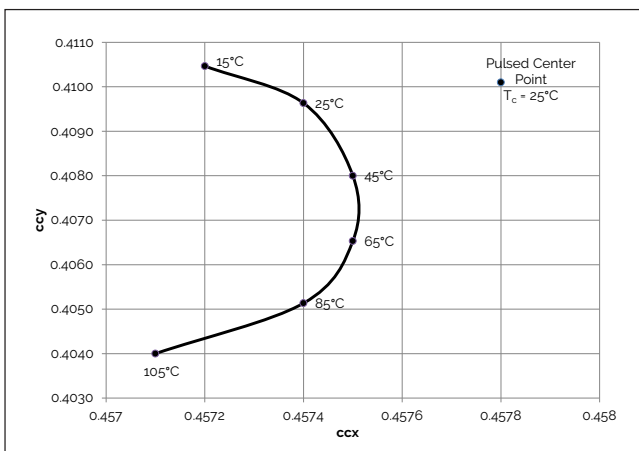
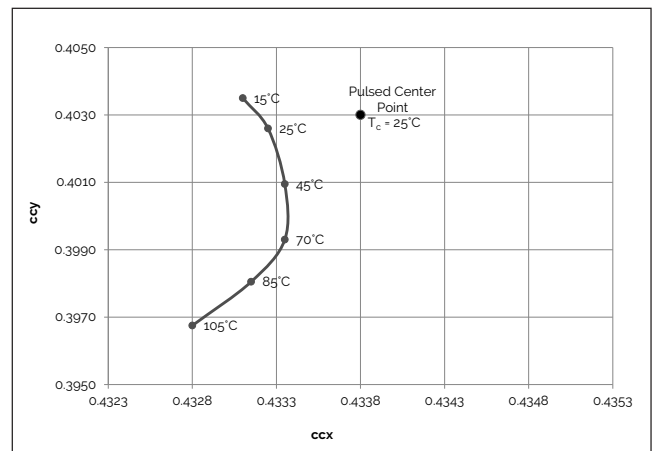

Figure 15: 3000K, 97 CRI Color Shift vs. Case Temperature¹



Notes for Figures 10-15:

1. Measurements made under DC test conditions at the nominal drive current.
2. Typical color shift is shown with a tolerance of ± 0.002 .
3. Characteristics shown for Decor Series Showcase products, BXRC-30G400C-x-73-SE
4. Color shift shown for product hot targeted at $T_c = 85^\circ\text{C}$

Performance Curves

Figure 16: 5600K Color Shift vs. Case Temperature¹

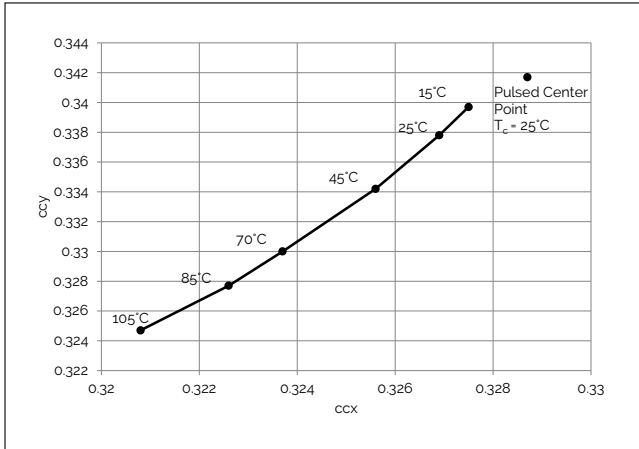

Figure 17: 3000K Class A Color Shift vs. Case Temperature¹

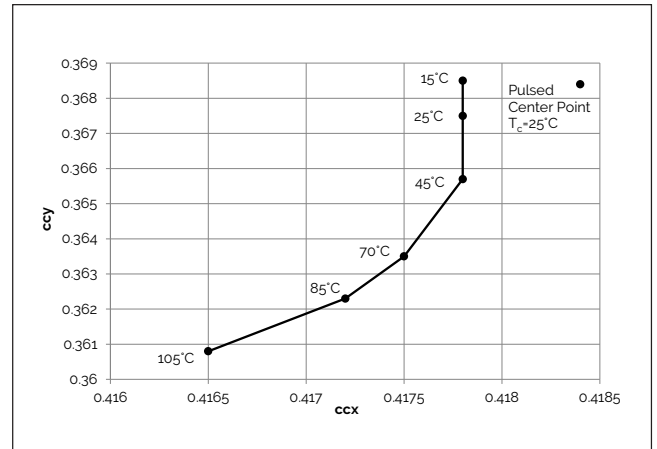

Figure 18: 3500K Class A Color Shift vs. Case Temperature¹

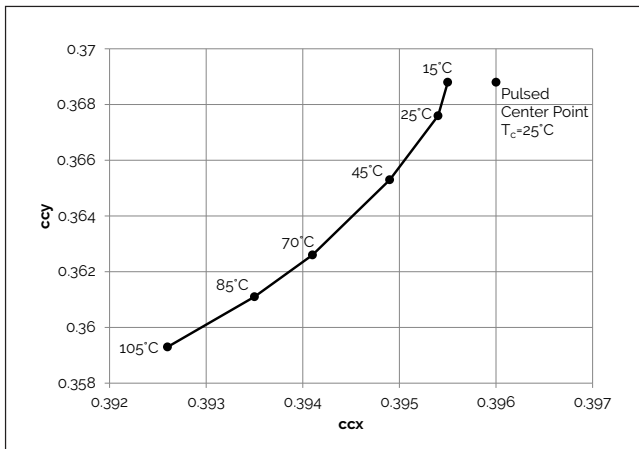
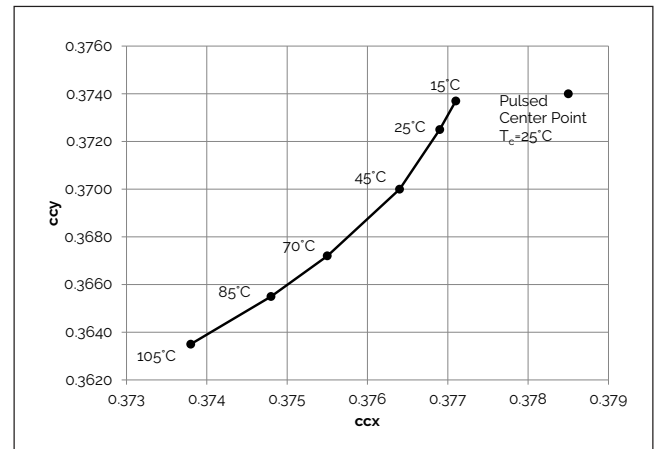

Figure 19: 4000K Class A Color Shift vs. Case Temperature¹



Notes for Figures 16-19:

1. Measurements made under DC test conditions at the nominal drive current.
2. Typical color shift is shown with a tolerance of ± 0.002 .

Typical Radiation Pattern

Figure 20: Typical Spatial Radiation Pattern

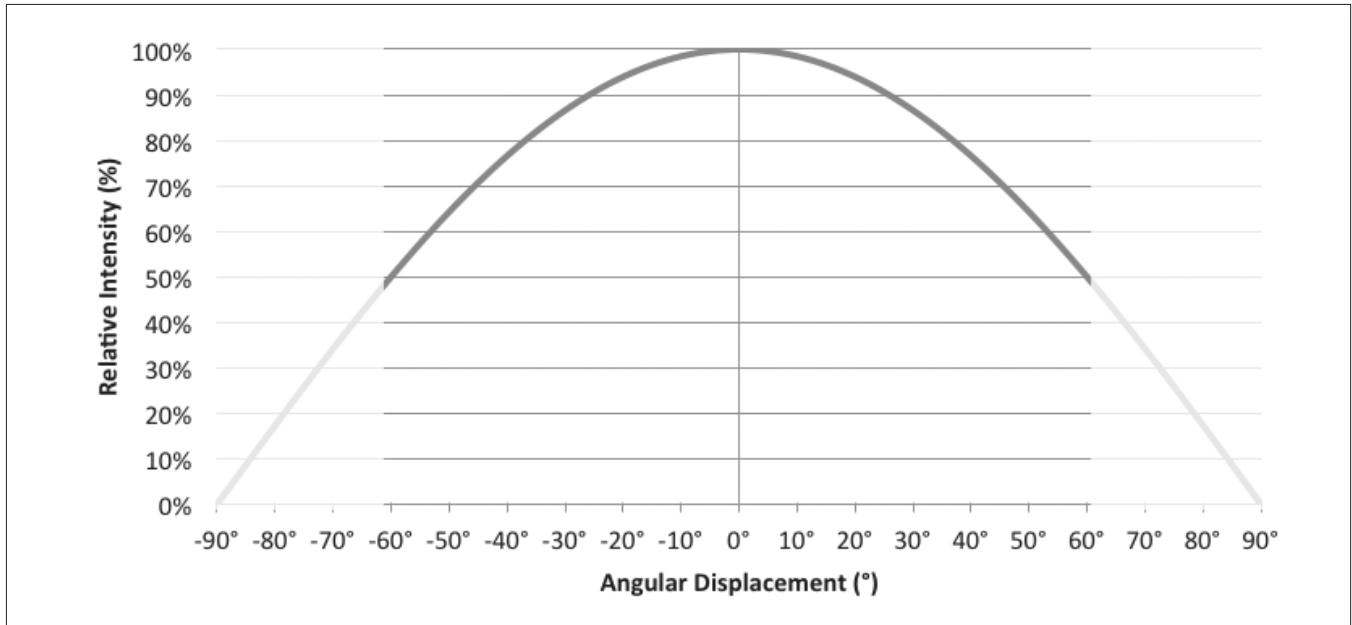

Notes for Figure 20:

1. Typical viewing angle is 120°.
2. The viewing angle is defined as the off axis angle from the centerline where intensity is ½ of the peak value.

Figure 21: Typical Polar Radiation Pattern

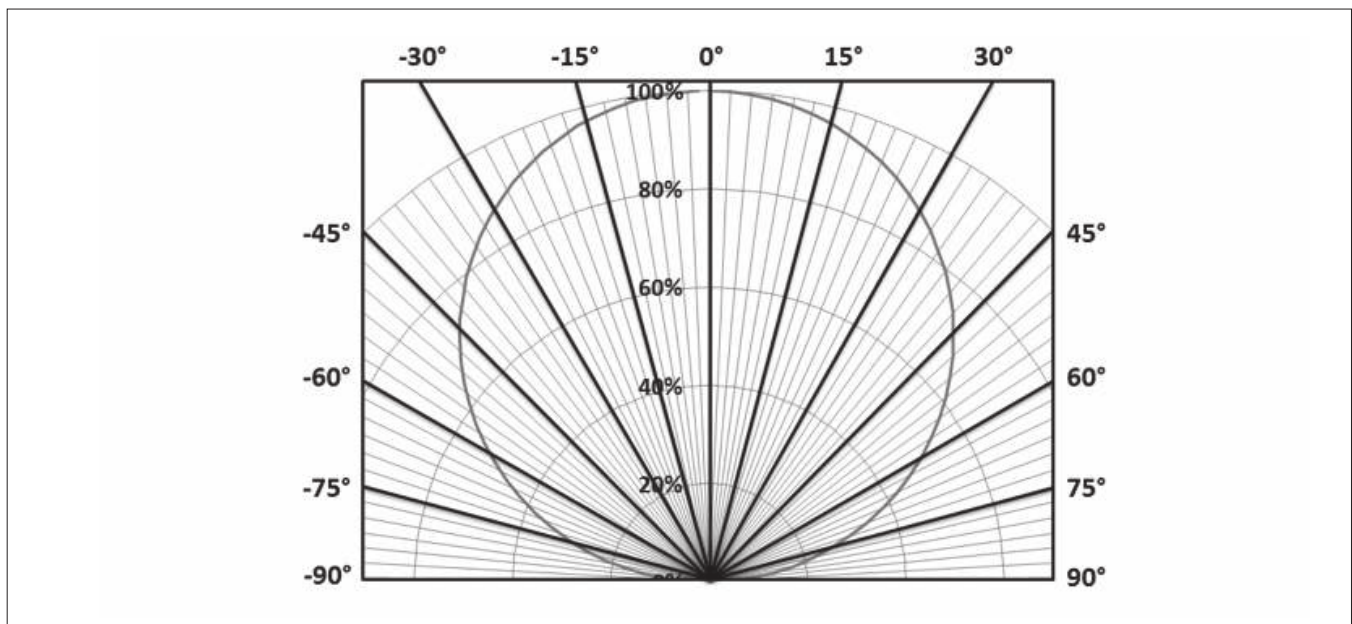

Typical Color Spectrum

Figure 22: Typical Color Spectrum

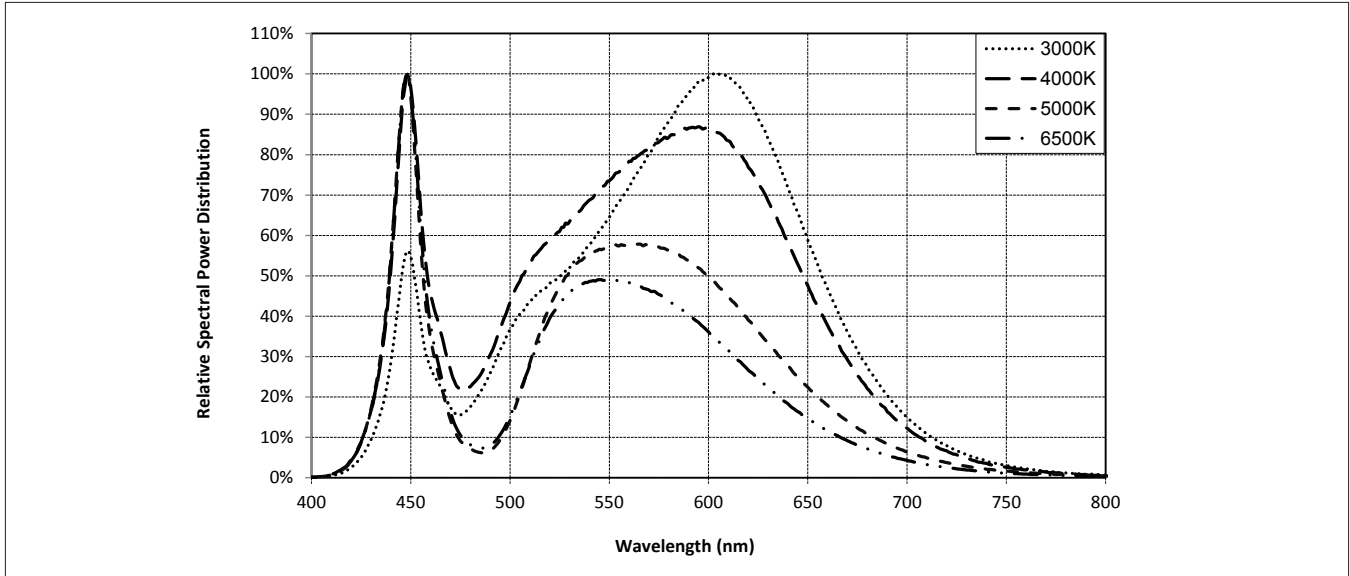

Note for Figure 22:

1. Color spectra measured at nominal current for $T_j = T_c = 25^\circ\text{C}$.
2. Color spectra shown is 3000K and 80 CRI.
3. Color spectra shown is 4000K and 80 CRI.
4. Color spectra shown is 5000K and 70 CRI.
4. Color spectra shown is 6500K and 70 CRI.

Figure 23: Typical Color Spectrum for Vero SE 18 with Décor Series

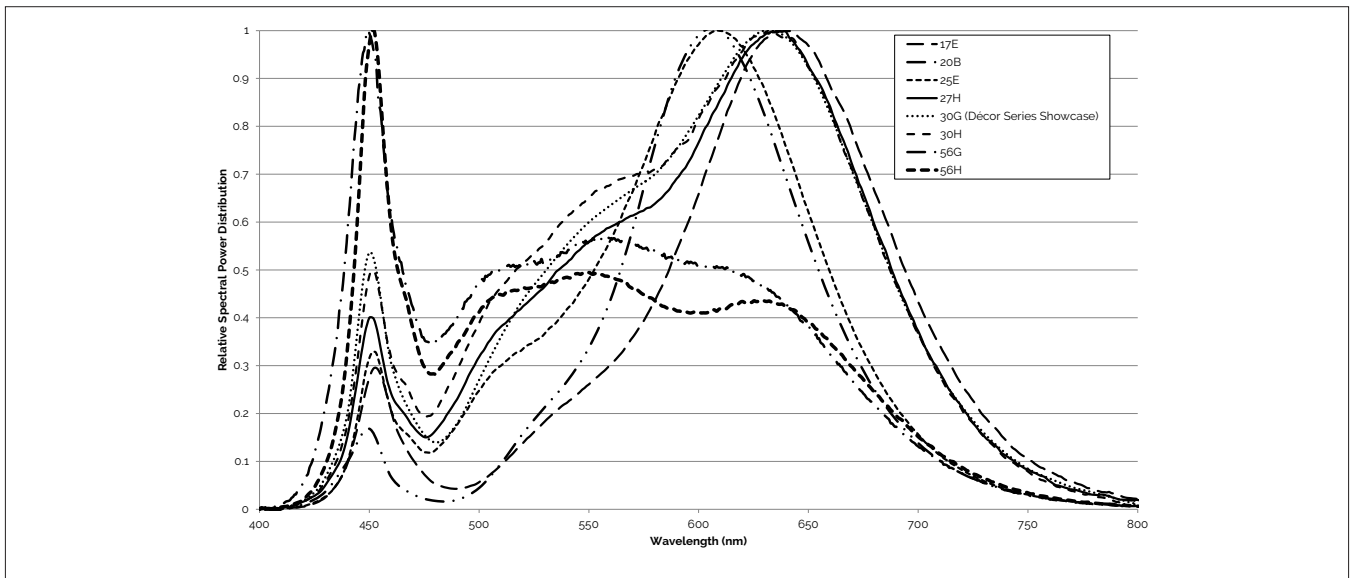

Note for Figure 23:

1. Color spectra measured at nominal current for $T_j = T_c = 25^\circ\text{C}$.

Mechanical Dimensions

Figure 24: Drawing for Vero SE 18 LED Array

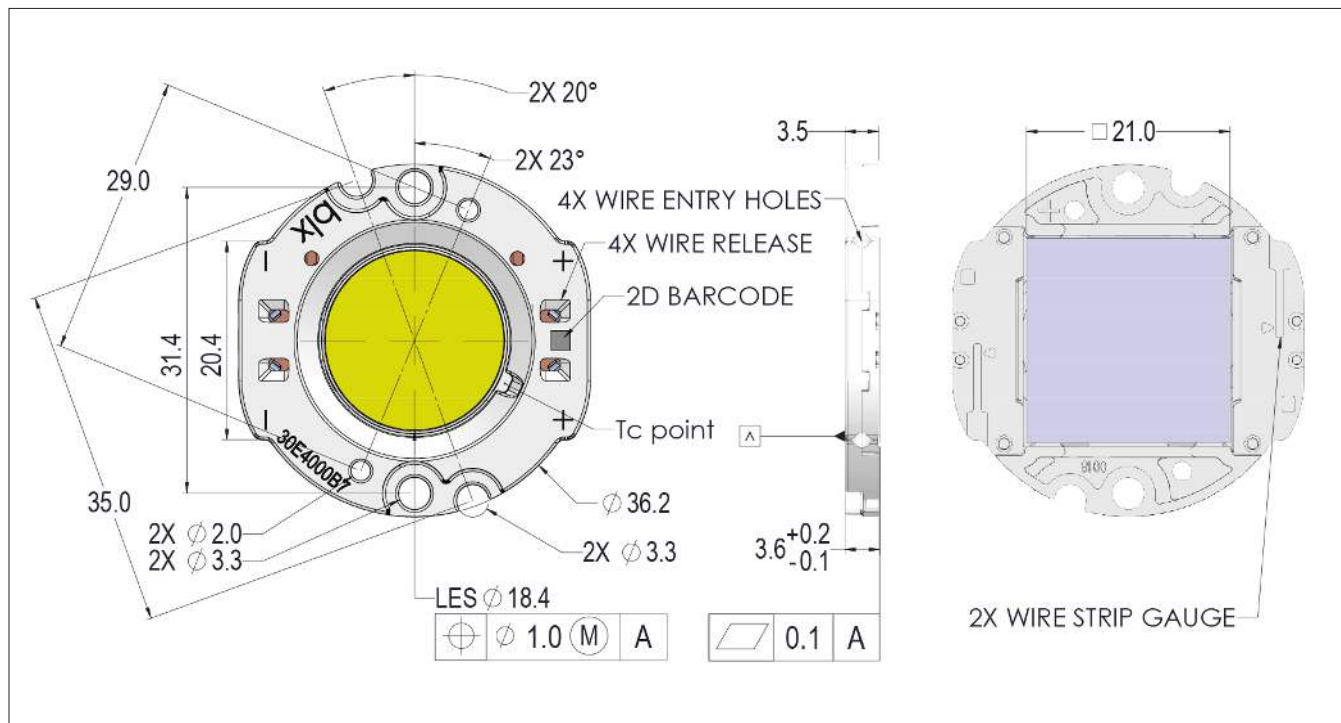

Notes for Figure 24:

1. Drawings are not to scale.
2. Drawing dimensions are in millimeters.
3. Unless otherwise specified, tolerances are $\pm 0.1\text{mm}$.
4. Mounting holes (2X) are for M3 screws.
5. Bridgelux recommends two tapped holes for mounting screws with $31.4 \pm 0.10\text{mm}$ center-to-center spacing.
6. Screws with flat shoulders (pan, dome, button, round, truss, mushroom) provide optimal torque control. Do NOT use flat, countersink, or raised head screws.
7. The optical center of the LED Array is nominally defined by the mechanical center of the array to a tolerance of $\pm 0.2\text{mm}$.
8. Bridgelux maintains a flatness of 0.10mm across the mounting surface of the array.

Color Binning Information

Figure 25: Warm and Neutral White Test Bins in xy Color Space

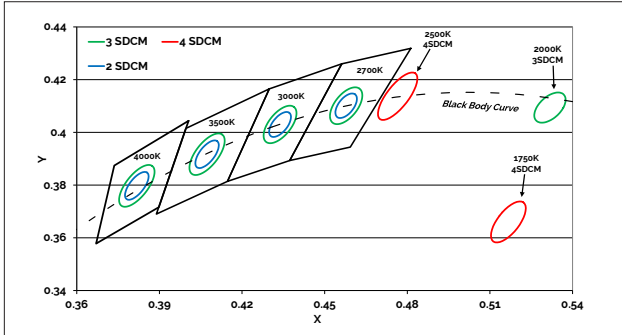

Note: Pulsed Test Conditions, $T_c = 25^\circ\text{C}$

Table 8: Warm and Neutral White xy Bin Coordinates and Associated Typical CCT

Bin Code	1750K	2000K	2500K	2700K	3000K ¹	3500K ¹	4000K ¹
ANSI Bin (for reference only)	-	-	-	(2580K - 2870K)	(2870K - 3220K)	(3220K - 3710K)	(3710K - 4260K)
73 (3 SDCM)	-	-	-	(2651K - 2794K)	(2968K - 3136K)	(3369K - 3586K)	(3851K - 4130K)
72 (2 SDCM)	-	-	-	(2674K - 2769K)	(2995K - 3107K)	(3404K - 3548K)	(3895K - 4081K)
Center Point (x,y)	(0.5167, 0.336)	(0.5280, 0.4100)	(0.4765, 0.4137)	(0.4578, 0.4101)	(0.4338, 0.403) (0.4465, 0.4024) ²	(0.4073, 0.3917)	(0.3818, 0.3797)

Note for Table 8:

1. Color Binning information excludes Decor Series Class A products. Please contact your Bridgelux Sales Representative for more information.
2. Center Point for Decor Series Showcase.

Figure 26: Graph of Cool White Test Bins in xy Color Space

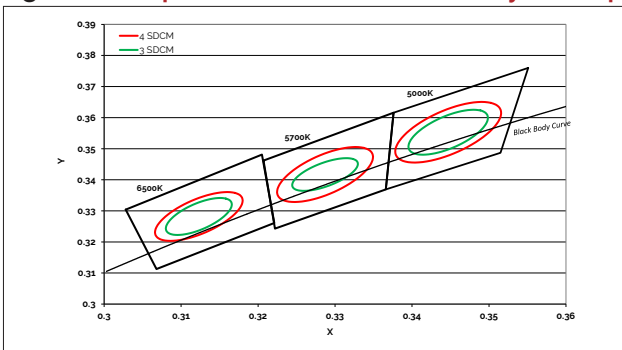

Note: Pulsed Test Conditions, $T_c = 25^\circ\text{C}$

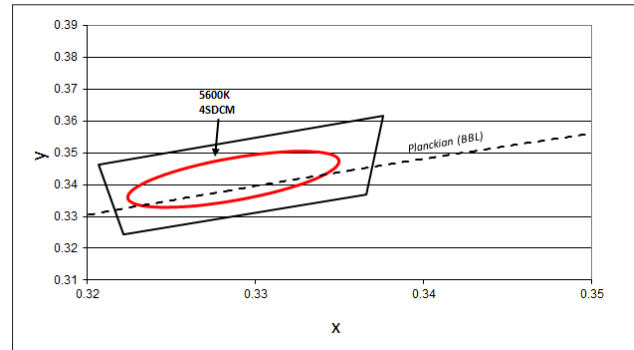

Table 9: Cool White xy Bin Coordinates and Associated Typical CCT (product is hot targeted to $T_c = 85^\circ\text{C}$)

Bin Code	5000K	5600K ¹	5700K	6500K
ANSI Bin (for reference only)	(4745K - 5311K)	(5310K - 6020K)	(5312K - 6022K)	(6022K - 7042K)
74 (4 SDCM)	(4801K - 5282K)	(5475K - 5830K)	(5829K - 5481K)	(6270K - 6765K)
73 (3 SDCM)	(4835K - 5215K)	(5490K - 5820K)	(5490K - 5820K)	(6250K - 6745K)
Center Point (x,y)	(0.3447, 0.3553)	(0.3293, 0.3423)	(0.3287, 0.3417)	(0.3123, 0.3282)

Note for Table 9:

1. Select configurations with a CCT of 5600K are available with center point targets at $T_c = 85^\circ\text{C}$ or $T_c = 25^\circ\text{C}$.

Packaging and Labeling

Figure 28: Vero SE Series Packaging and Labeling

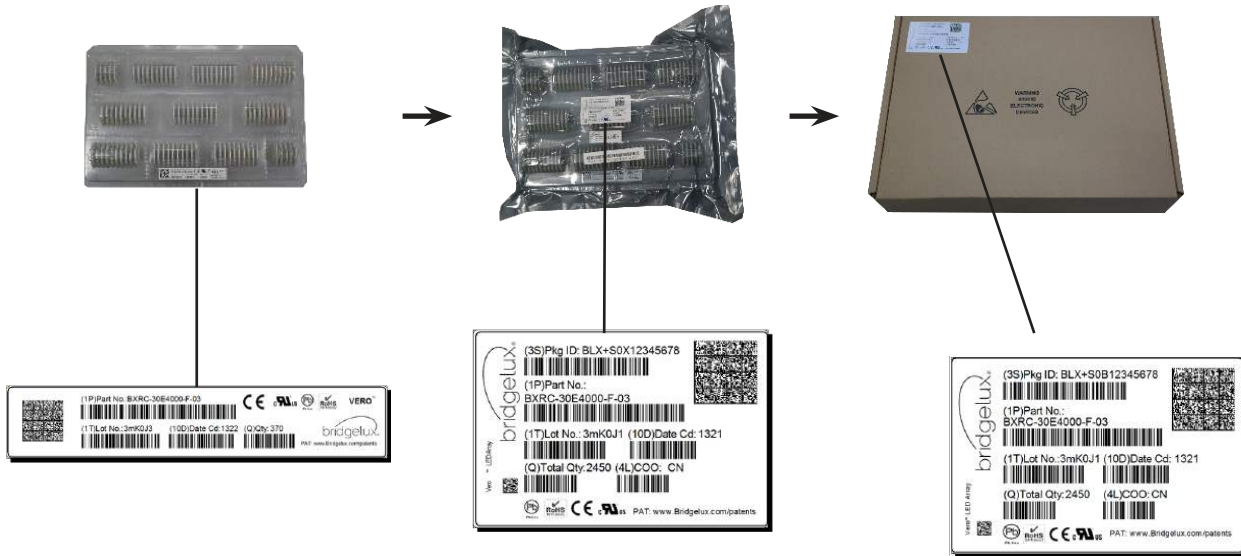

Notes for Figure 28:

1. Each tray holds 100 COBs.
2. Each tray is vacuum sealed in an anti-static bag and placed in its own box.
3. Each tray, bag and box is to be labeled as shown above.

Figure 29: Vero SE Product Labeling

Bridgelux COB arrays have laser markings on the back side of the substrate to help with product identification. In addition to the product identification markings, Bridgelux COB arrays also contain markings for internal Bridgelux manufacturing use only. The image below shows which markings are for customer use and which ones are for Bridgelux internal use only. The Bridgelux internal manufacturing markings are subject to change without notice, however these will not impact the form, function or performance of the COB array.



Customer Use- 2D Barcode
Scannable barcode provides product part number and other Bridgelux internal production information.

Customer Use- Product part number

30E4000C 73 2F

Customer Use- V_f Bin Code
included to enable greater luminaire design flexibility. Refer to ANg2 for bin definitions.

Design Resources

Application Notes

Bridgelux has developed a comprehensive set of application notes and design resources to assist customers in successfully designing with the Vero product family of LED array products. For all available application notes visit www.bridgelux.com.

Optical Source Models

Optical source models and ray set files are available for all Bridgelux products. For a list of available formats, visit www.bridgelux.com.

3D CAD Models

Three dimensional CAD models depicting the product outline of all Bridgelux Vero LED arrays are available in both IGS and STEP formats. Please contact your Bridgelux sales representative for assistance.

LM80

LM80 testing has been completed and the LM80 report is now available. Please contact your Bridgelux sales representative for LM-80 report.

Precautions

CAUTION: CHEMICAL EXPOSURE HAZARD

Exposure to some chemicals commonly used in luminaire manufacturing and assembly can cause damage to the LED array. Please consult Bridgelux Application Note AN121 for additional information.

CAUTION: RISK OF BURN

Do not touch the Vero LED array during operation. Allow the array to cool for a sufficient period of time before handling. The Vero LED array may reach elevated temperatures such that could burn skin when touched.

CAUTION

CONTACT WITH LIGHT EMITTING SURFACE (LES)

Avoid any contact with the LES. Do not touch the LES of the LED array or apply stress to the LES (yellow phosphor resin area). Contact may cause damage to the LED array.

Optics and reflectors must not be mounted in contact with the LES (yellow phosphor resin area). Optical devices may be mounted on the top surface of the plastic housing of the Vero LED array. Use the mechanical features of the LED array housing, edges and/or mounting holes to locate and secure optical devices as needed.

Disclaimers

MINOR PRODUCT CHANGE POLICY

The rigorous qualification testing on products offered by Bridgelux provides performance assurance. Slight cosmetic changes that do not affect form, fit, or function may occur as Bridgelux continues product optimization.

STANDARD TEST CONDITIONS

Unless otherwise stated, array testing is performed at the nominal drive current.

About Bridgelux: Bridging Light and Life™

At Bridgelux, we help companies, industries and people experience the power and possibility of light. Since 2002, we've designed LED solutions that are high performing, energy efficient, cost effective and easy to integrate. Our focus is on light's impact on human behavior, delivering products that create better environments, experiences and returns—both experiential and financial. And our patented technology drives new platforms for commercial and industrial luminaires.

For more information about the company, please visit
bridgelux.com
twitter.com/Bridgelux
facebook.com/Bridgelux
youtube.com/user/Bridgelux
linkedin.com/company/bridgelux-inc-_2
WeChat ID: BridgeluxInChina



46430 Fremont Boulevard
Fremont, CA 94538 U.S.A.
Tel (925) 583-8400
www.bridgelux.com

© 2016-2018 Bridgelux, Inc. All rights reserved 2018. Product specifications are subject to change without notice. Bridgelux, the Bridgelux stylized logo design, Vero, V Series and V Series HD are registered trademarks, and Decor Series is a trademark of Bridgelux, Inc. All other trademarks are the property of their respective owners.

Bridgelux Vero SE 18 Array Series Product Data Sheet DS122 Rev. K (11/2018)