



TND027SW

Excellent Power Device

Lowside Power Switch Lamp-, Solenoid-, and Motor-Driving, Dual SOIC8

ON Semiconductor®

<http://onsemi.com>

Features

- N-channel MOSFET built in
- Overheat protection (Self recovery type)
- Overcurrent protection (Self recovery type current limiting function)
- Overvoltage protection
- Incorporates two sets of circuit
- Halogen free compliance

Specifications

Absolute Maximum Ratings at Ta=25°C

Parameter	Symbol	Conditions	Ratings	Unit
Drain-to-Source Voltage	V _{DS}		60	V
Output Current	I _{O(DC)}		1.5	A
Input Voltage	V _{IN}		-0.3 to +10	V
Allowable Power Dissipation	P _D	When mounted on ceramic substrate (1200mm ² ×0.8mm) 1unit	1.3	W
		When mounted on ceramic substrate (1200mm ² ×0.8mm)	1.7	W
Operating Supply Voltage	V _{DS(opr)}		40	V
Operating Temperature	T _{opr}		-40 to +85	°C
Junction Temperature	T _j		150	°C
Storage Temperature	T _{stg}		-55 to +150	°C

Stresses exceeding Maximum Ratings may damage the device. Maximum Ratings are stress ratings only. Functional operation above the Recommended Operating Conditions is not implied. Extended exposure to stresses above the Recommended Operating Conditions may affect device reliability.

Package Dimensions

unit : mm (typ)

7072-003

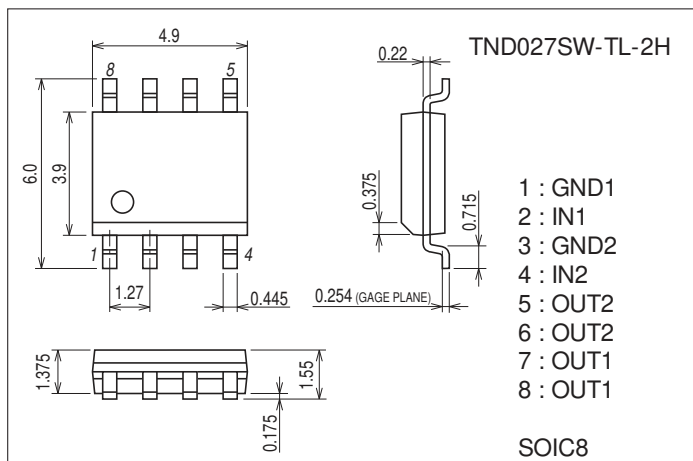

Product & Package Information

- Package : SOIC8
- JEITA, JEDEC : SC-87, SOT-96
- Minimum Packing Quantity : 2,500 pcs./reel

Packing Type: TL

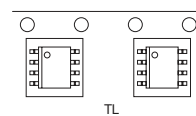

Marking

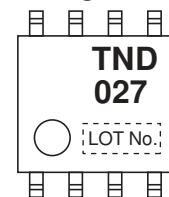

Block Diagram

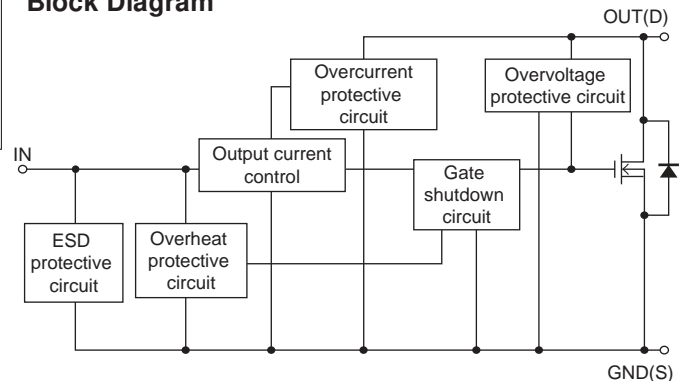

TND027SW

Electrical Characteristics at Ta=25°C

Parameter	Symbol	Conditions	Ratings			Unit
			min.	typ.	max.	
Drain-to-Source Clamp Voltage	$V_{DS, clamp}$	$V_{IN}=0V, I_O=1mA$	60			V
Output-OFF Current	I_{DSS1}	$V_{IN}=0V, V_{DS}=50V$			10	μA
	I_{DSS2}	$V_{IN}=0V, V_{DS}=12V$			5	μA
Input Threshold Voltage	$V_{IN(th)}$	$V_{DS}=5V, I_O=1mA$	1.0	1.5	2.0	V
Protection Circuit Operating Input Voltage	$V_{IN(opr)}$		4		10	V
Drain-to-Source ON Resistance	$R_{DS(on)}$	$V_{IN}=5V, I_O=1A$		0.3	0.4	Ω
Input Current (Output On)	I_{IN}	$V_{IN}=5V$			0.6	mA
Over-Heat Detecting Temperature	$T_{j(sd)}$	$V_{IN}=5V, I_O=1A$	120	150	190	$^{\circ}C$
Over-Current Detecting Current	I_s	$V_{IN}=5V$	3.0	6.0	9.0	A
Over-Current Limit (Peak)	I_{LMT}	$V_{IN}=5V$	3.0	6.0	9.0	A
Input Clamp Voltage	$V_{IN, clamp}$	$I_{IN}=1mA$	10			V

- Notes : 1. Overcurrent protection circuit limits the output current to the range of overcurrent limit value.
 2. During overheating protecting operation, output current is turned off.

Ordering Information

Devices	Package	Shipping	memo
TND027SW-TL-2H	SOIC8	2,500pcs./reel	Pb Free and Halogen Free

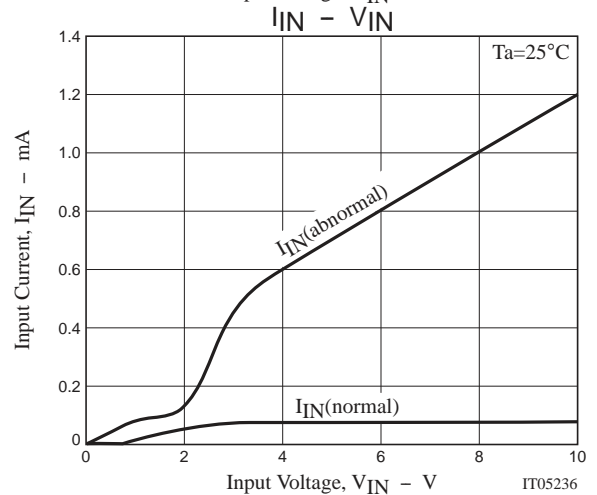
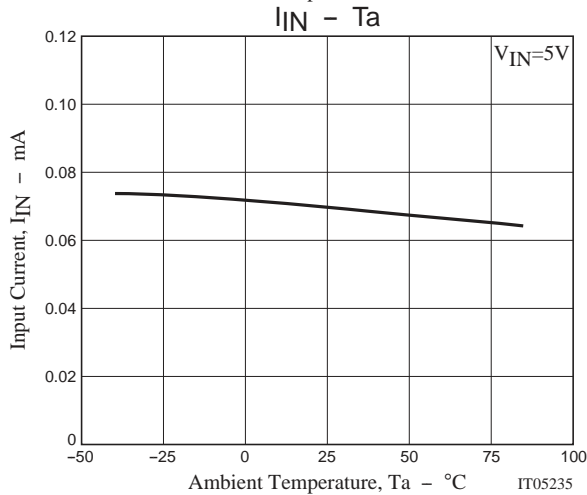
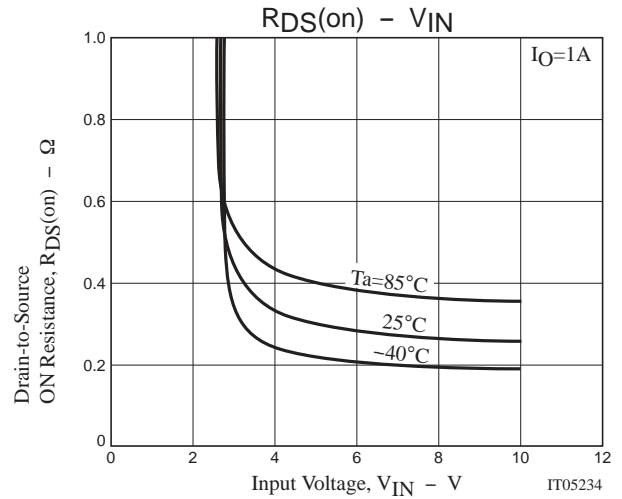
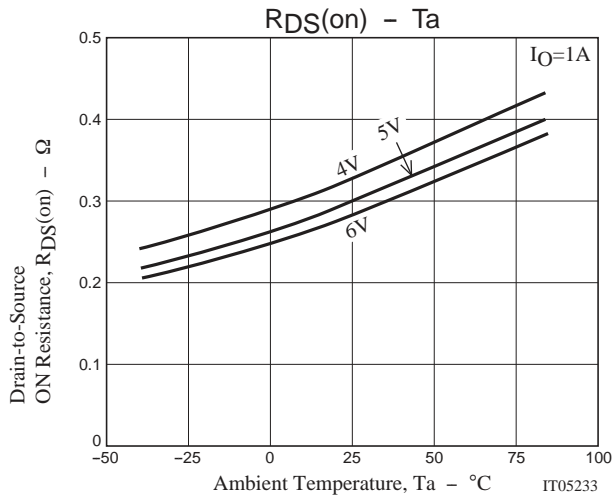

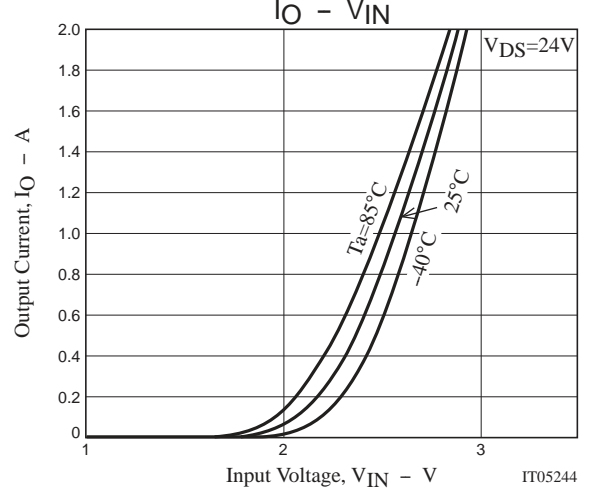
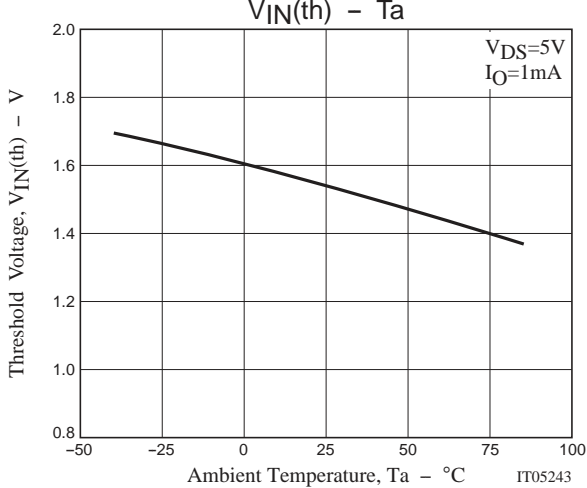
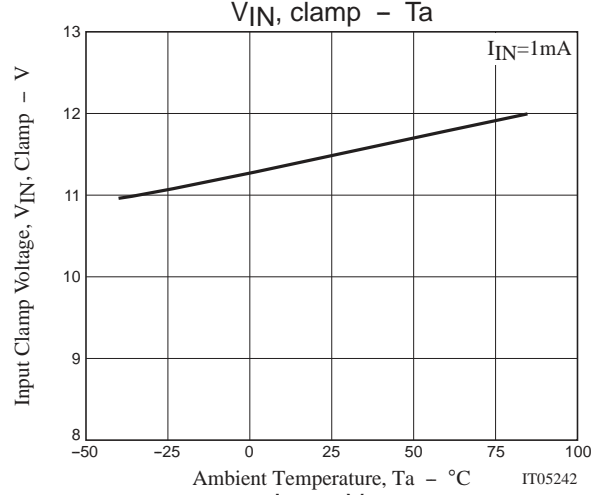
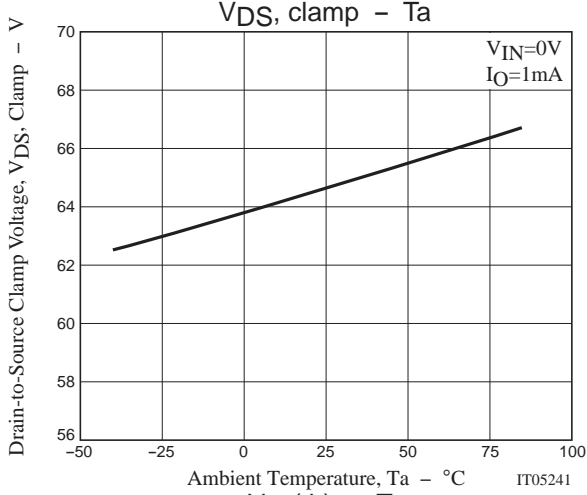
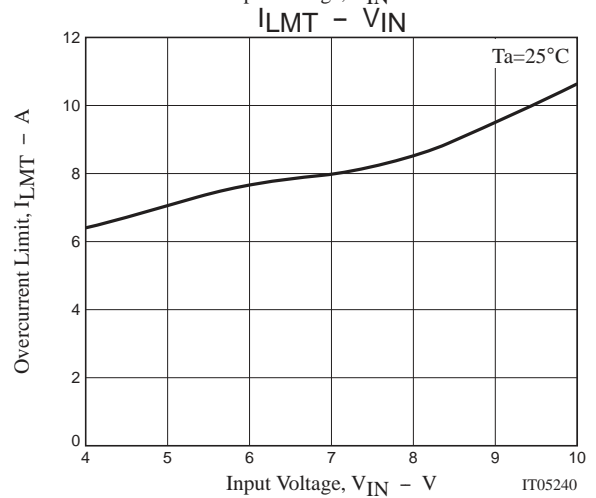
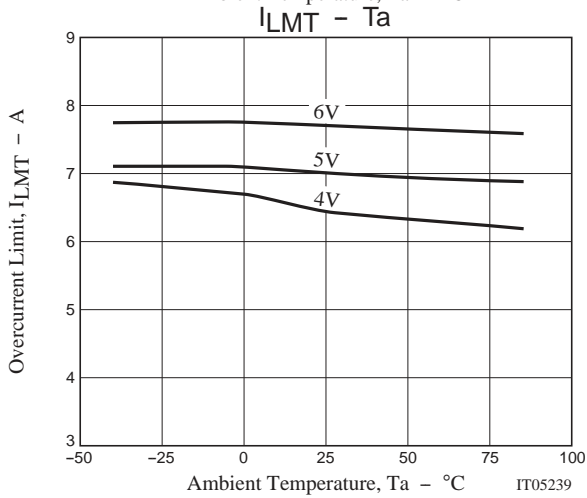
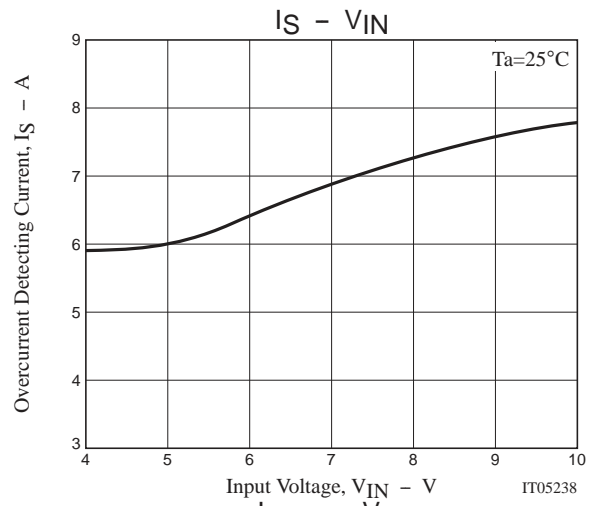
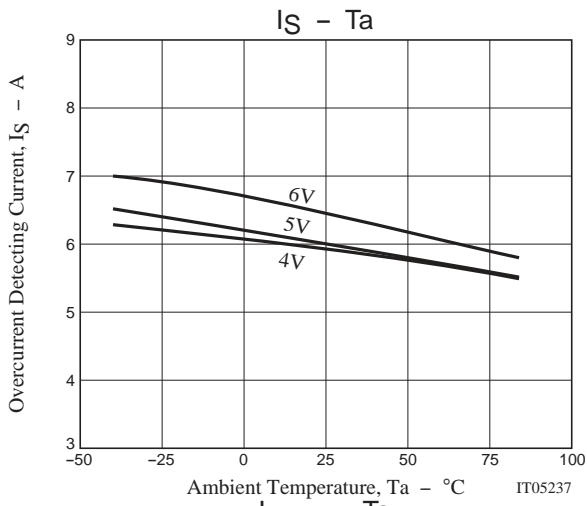

TND027SW

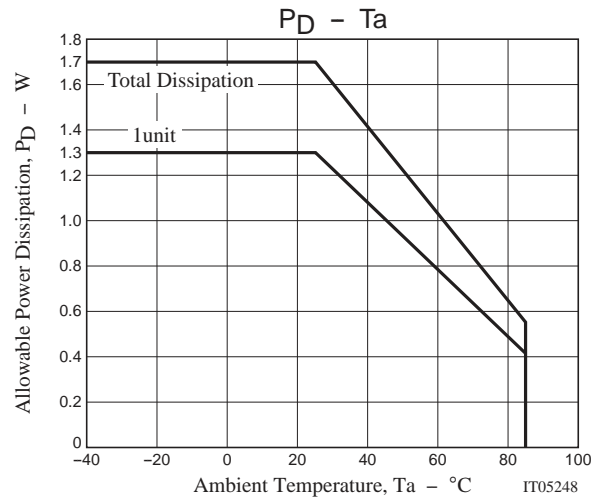
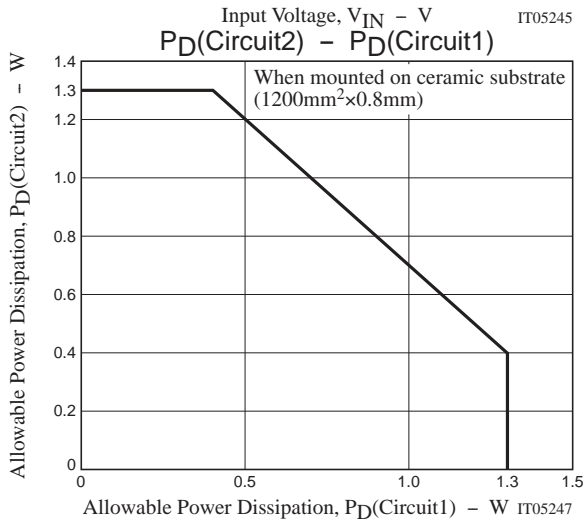
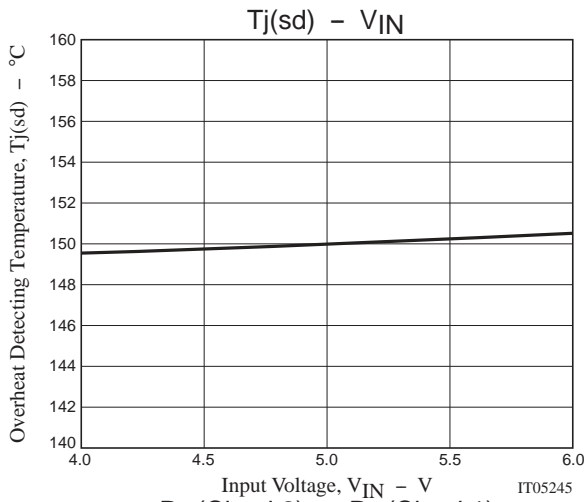

Sample Application Circuit

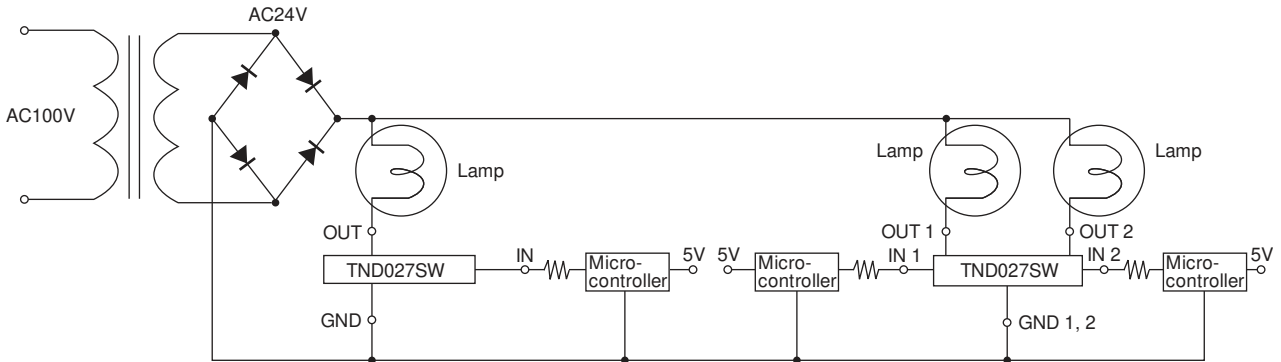

Another Sample Application Circuit (Solenoid drive)

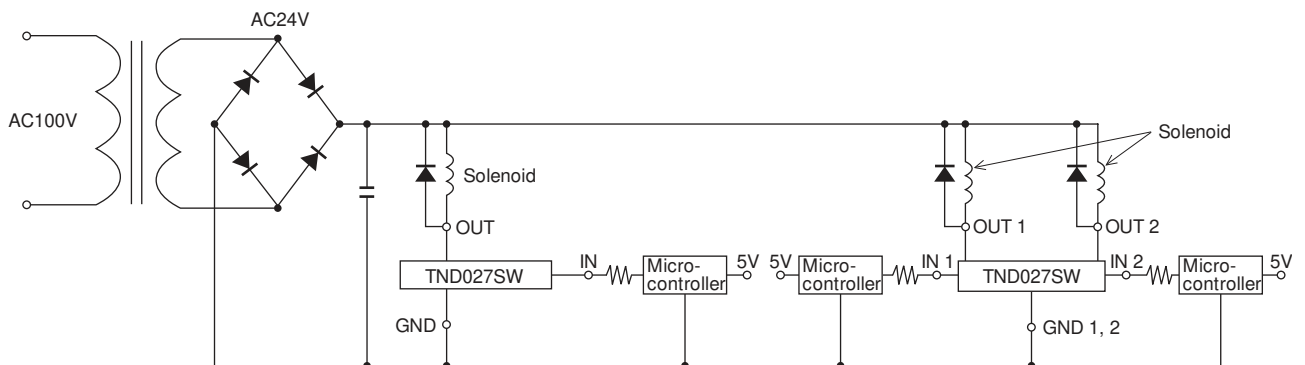

Operation Description

- The output power MOSFET will be turned on when the input voltage exceeds the input threshold voltage (4 to 6V is recommended), and then the lamp will be turned on by the current flowing to the lamp. Conversely, the output power MOSFET will be turned off when the input voltage goes below the input threshold voltage, and the lamp will be turned off.
- The inrush current that occurs during normal lamp operation is limited to a preset value by the built-in overcurrent protecting circuit, which makes the lamp life longer.
- The internal overcurrent protection function limits the current of output power MOSFET when output current of at least the overcurrent detecting current value flows at load short. Besides, if the device temperature exceeds the allowable power dissipation, overheat protection function protects the power switch from being broken down by turning off the current of output power MOSFET when T_j comes to 150°C (typical).
- As an example of application circuit, DC voltage can also be controlled as a solenoid drive.

Addition

- The diode between OUT and GND in the block diagram is parasitic diode of the MOSFET.
- Not apply a voltage on IN terminal during the period when OUT voltage is lower than GND voltage when driving a solenoid or a motor.
- Be sure connect a diode between OUT terminal and GND terminal when you want to apply a voltage on IN terminal under the above-stated state (that is, OUT Voltage < GND Voltage).

Taping Specification

TND027SW-TL-2H

1. Packing Format

Package Name	Carrier Tape Type	Maximum Number of devices contained (pcs)			Packing format	
		Reel	Inner box	Outer box	Inner BOX W206-112	Outer BOX W207-124
SOIC8	B202-101	2,500	12,500	25,000	5 reels contained Dimensions :mm(external) 340×95×340	2 inner boxes contained Dimensions :mm(external) 360×210×375

Packing method

Reel label, Inner box label
(unit: mm)

Outer box label

It is a label at the time of factory shipments.
The form of a label may change in physical distribution process.

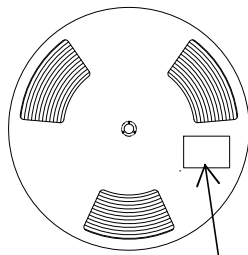

Type No. →
LOT No. →
Quantity →
Origin →

Reel label

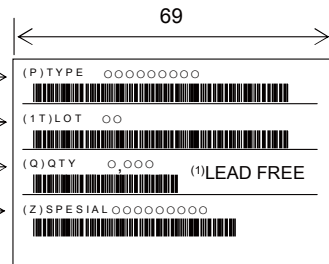

NOTE(1)

The LEAD FREE 4 description shows that it is complete lead free.

43
80

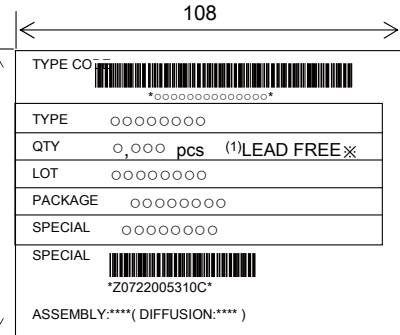

Label	JEITA Phase
LEAD FREE 4	JEITA Phase 3

2. Taping configuration

2-1. Carrier tape size (unit: mm)

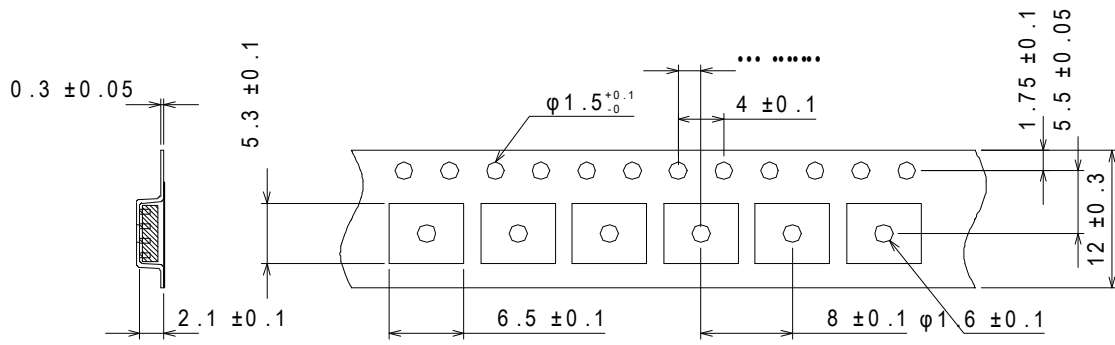

2-2. Device placement direction

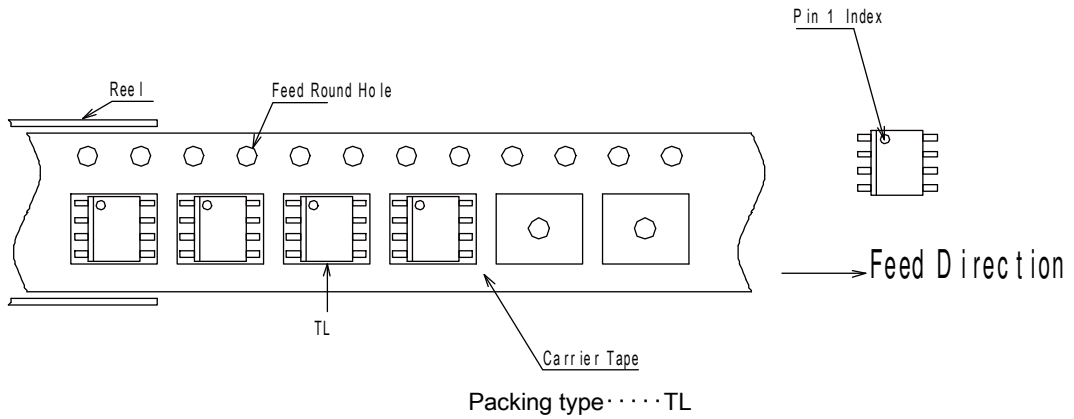

2-3. Leader portion and trailer portion (unit: mm)

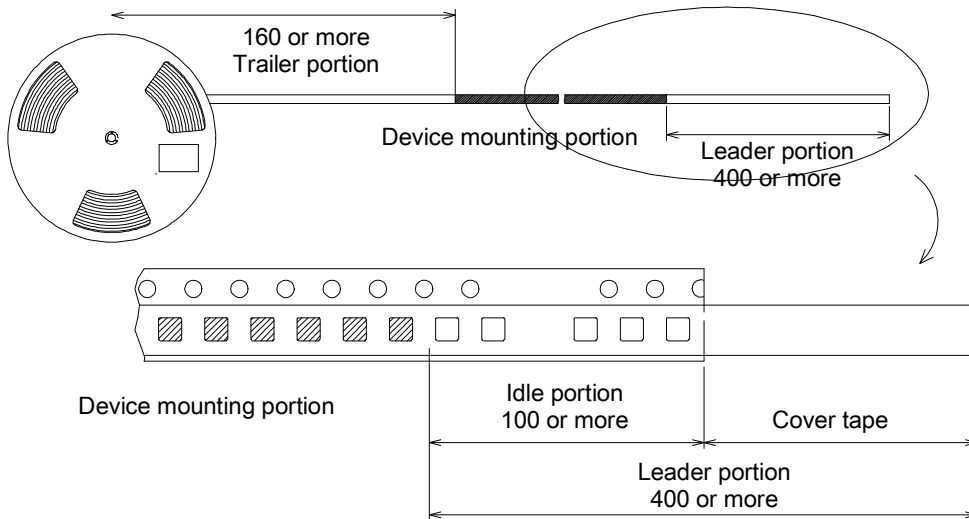

TND027SW

Outline Drawing

TND027SW-TL-2H

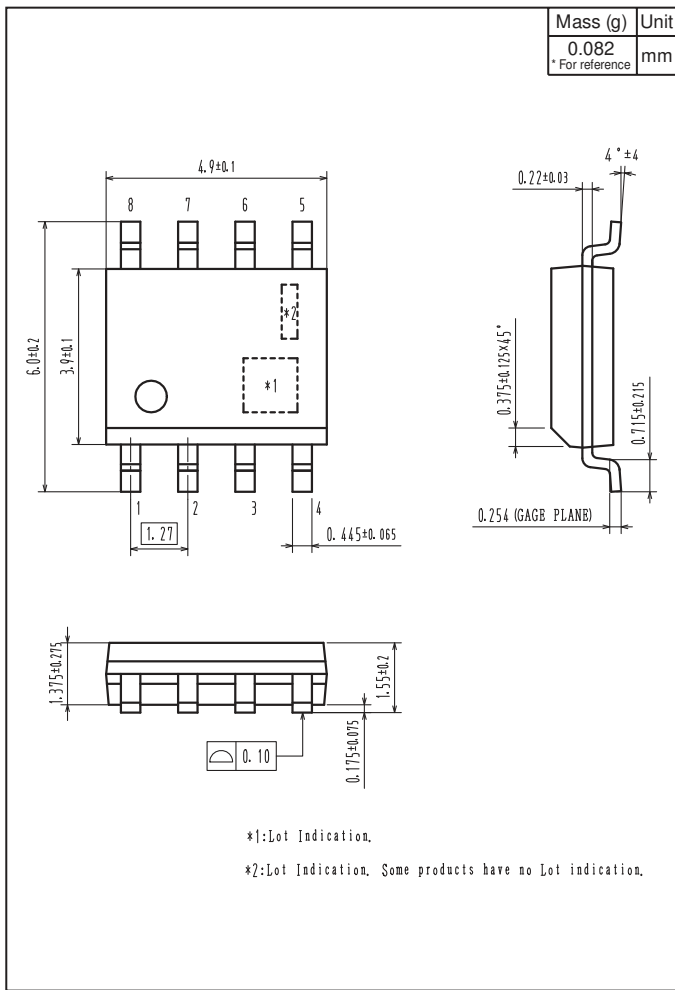

Land Pattern Example

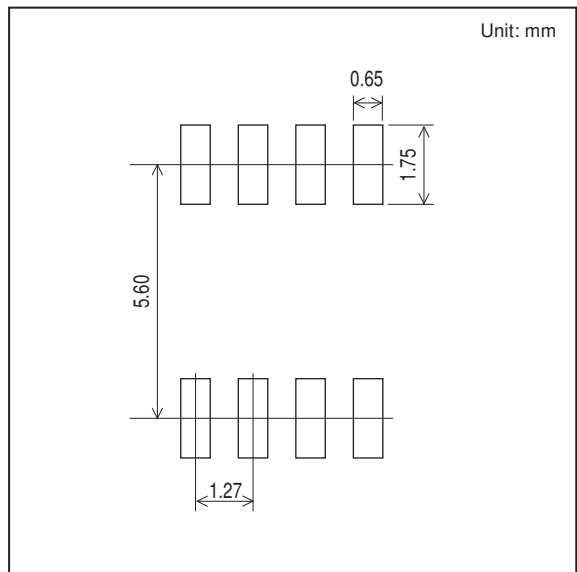

ON Semiconductor and the ON logo are registered trademarks of Semiconductor Components Industries, LLC (SCILLC). SCILLC owns the rights to a number of patents, trademarks, copyrights, trade secrets, and other intellectual property. A listing of SCILLC's product/patent coverage may be accessed at www.onsemi.com/site/pdf/Patent-Marking.pdf. SCILLC reserves the right to make changes without further notice to any products herein. SCILLC makes no warranty, representation or guarantee regarding the suitability of its products for any particular purpose, nor does SCILLC assume any liability arising out of the application or use of any product or circuit, and specifically disclaims any and all liability, including without limitation special, consequential or incidental damages. "Typical" parameters which may be provided in SCILLC data sheets and/or specifications can and do vary in different applications and actual performance may vary over time. All operating parameters, including "Typicals" must be validated for each customer application by customer's technical experts. SCILLC does not convey any license under its patent rights nor the rights of others. SCILLC products are not designed, intended, or authorized for use as components in systems intended for surgical implant into the body, or other applications intended to support or sustain life, or for any other application in which the failure of the SCILLC product could create a situation where personal injury or death may occur. Should Buyer purchase or use SCILLC products for any such unintended or unauthorized application, Buyer shall indemnify and hold SCILLC and its officers, employees, subsidiaries, affiliates, and distributors harmless against all claims, costs, damages, and expenses, and reasonable attorney fees arising out of, directly or indirectly, any claim of personal injury or death associated with such unintended or unauthorized use, even if such claim alleges that SCILLC was negligent regarding the design or manufacture of the part. SCILLC is an Equal Opportunity/Affirmative Action Employer. This literature is subject to all applicable copyright laws and is not for resale in any manner.