

OPB780-Kit

Color Sensor Evaluation Kit



- The OPB780-Kit is designed to provide the design engineer an easy way to evaluate the capability of the OPB780 Color Sensor.



The **OPB780Z** is a full color sensor with 4 different frequencies relating directly to a specific color seen by the sensor.

The **OPB780Z** color sensor uses a programmable light-to-frequency converter that combines 64 configurable silicon photodiodes (on a 144 um center array and measuring 120 um x 120 um each) and a current-to-frequency converter on a single monolithic CMOS integrated circuit, packaged in a small, lightweight package that makes it ideal for using in miniature applications.

The output is a square wave (50% duty cycle) with a frequency directly proportional to light chromaticity and irradiance from four filtered diode arrays.

The light-to-frequency converter reads an 8 x 8 array of photodiodes that consists of four groups of 16 photodiodes each, segregated by color: 16 photodiodes with red filters, 16 photodiodes with green filters, 16 photodiodes with blue filters and 16 photodiodes with clear filters. Each color's group of 16 photodiodes is interdigitated to minimize the effect of non-uniformity of incident irradiance. Each color's group is also connected in parallel. The type of photodiode used during operation is pin-selectable.

The internal photodiode used by the device is controlled by two logic inputs, S2 and S3.

Pin 4 (S2)	Pin 6 (S3)	Diode Filter
H	H	Green
H	L	Clear
L	L	Red
L	H	Blue

The output of the device is designed to drive a standard TTL or CMOS logic input over short distances.

Block

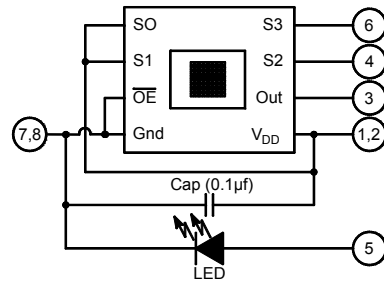
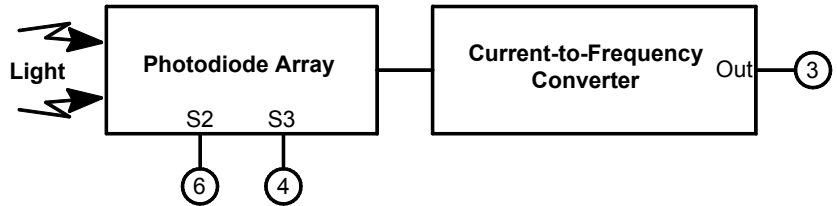

Pin Name	Pin #	Description
V _{DD}	1, 2	Supply voltage
OUT	3	Output Frequency (F _O)
S2	4	Photodiode type selection input
LED Anode	5	LED input
S3	6	Photodiode type selection input
GND/OE	7, 8	Sensor & LED Ground

DO NOT LOOK DIRECTLY AT LED WITH UNSHIELDED EYES OR DAMAGE TO RETINA MAY OCCUR.

The **OPB780Z** includes 10" [25.4cm] a Flat Flexible interface Cable. Custom lengths of the cable can be ordered either from OPTEK or most Flat Flexible Cable (FFC) manufactures. The FFC is designed to interface with an any standard 0.5mm spacing FFC connector similar to the AVX ELCO connector.
(part number 04 6249 0080 00 800+).

OPTEK reserves the right to make changes at any time in order to improve design and to supply the best product possible.

OPB780-Kit

Color Sensor Evaluation Kit



The **OPB780Z** consist of:

1. White LED for illumination of the target
2. Photodiode Array consisting of:
 - 16 Green Filter Diodes
 - 16 Clear Filter Diodes
 - 16 Red Filter Diodes
 - 16 Blue Filter Diodes
3. Current to Frequency Converter
4. TTL and CMOS Drive Circuitry
5. Plastic Package with 10: (25.4cm) FFC

All 16 photodiodes that have the same color filter are connected in parallel. Package pin numbers 4 (S2) and 6 (S3) can be used to select the desired photodiode/filter configuration to optimize color identification. All 64 photodiodes are 120µm x 120µm in size and are on 144µm centers.

The output frequency provided by the **OPB780Z** may vary from part to part and should be calibrated as required to meet each application. The more colors that are to be identified require more accurate calibration and longer sampling rate. A small amount of jitter will be present in the frequency provided for a color and must be taken into consideration depending on the accuracy required.

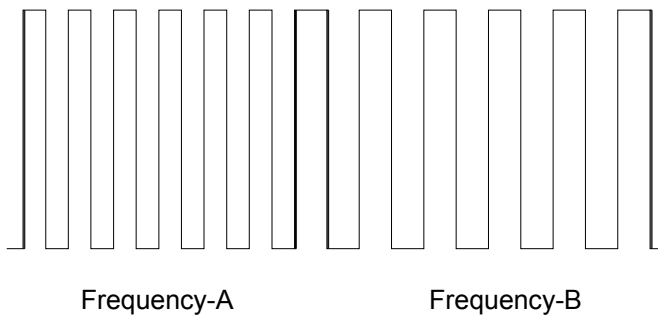

The internal scaling is preconfigured for the highest frequency output of typically 600kHz. The 600kHz frequency shortens the sampling time providing a small amount of jitter in the output frequency.

The user must take into consideration the luminance intensity (amount of light) that may be acknowledged by the human eye. As the luminance intensity decreases, the amount of color recognized is diminished. In order to consistently reproduce a specific color with the same output frequency, the luminance intensity must be the consistent. When critical identification of specific colors is required, the angle of view and distance may critical characteristics.

The **OPB780Z** photodiodes as provided are designed to recognize ultraviolet, visible as well as near infrared wavelengths (from 300 to 1,050 nanometers) The graphs below show the typical Spectral Response for each photodiode configuration. When a near infrared rejecting filter similar to the Hoya CM500 is placed in front of the sensor, the higher wavelengths (above 700 nm) are eliminated thus enhancing recognition of colors in the visible range.

Typical Spectral Response Full Wavelength Sensitivity

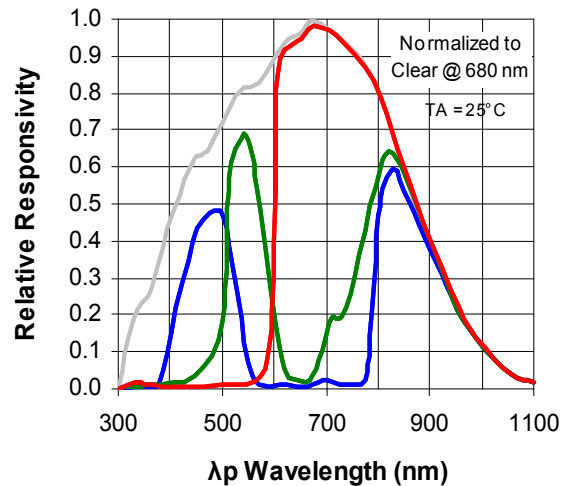

Spectral Response

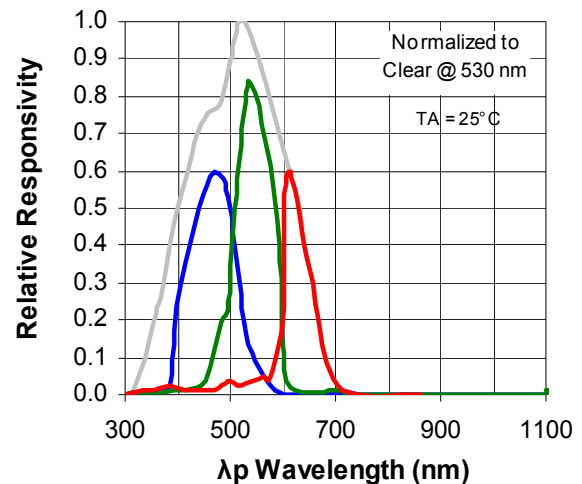

The standard product allows the **OPB780Z** to be used to recognize colors over the full wavelength of 300nm to 1100nm beyond those of the human visual range.

OPTEK reserves the right to make changes at any time in order to improve design and to supply the best product possible.

OPB780-Kit

Color Sensor Evaluation Kit



Below are the operating characteristics of the **OPB780Z**. As the ambient temperature or other environmental conditions change, the values noted may vary. The **OPB780Z** is designed to operate

between -40°C and $+85^{\circ}\text{C}$. The **OPB780Z** provides consistent recognition of a color given constant environmental conditions.

Operating Characteristics at $V_{DD} = 5\text{ V}$, $T_A = 25^{\circ}\text{C}$

Parameter	Test Conditions	Clear Diode			Blue Diode			Green Diode			Red Diode			Units
		S2 = H, S3 = L			S2 = L, S3 = H			S2 = H, S3 = H			S2 = L, S3 = L			
		Min	Typ	Max	Min	Typ	Max	Min	Typ	Max	Min	Typ	Max	
Output Frequency (f_o)	$E_e = 47.2\ \mu\text{W}/\text{cm}^2$ $\lambda_P = 470\ \text{nm}$	16.0	20.0	24.0	11.2	16.4	21.6	-	-	-	-	-	-	kHz
	$E_e = 40.4\ \mu\text{W}/\text{cm}^2$ $\lambda_P = 524\ \text{nm}$	16.0	20.0	24.0	-	-	-	8.0	13.6	19.2	-	-	-	kHz
	$E_e = 34.6\ \mu\text{W}/\text{cm}^2$ $\lambda_P = 640\ \text{nm}$	16.0	20.0	24.0	-	-	-	-	-	-	14.0	19.0	24.0	kHz
Dark Frequency	$E_e = 0$	-	2	12	-	2	12	-	2	12	-	2	12	Hz
Irradiance Responsivity (R_e) (See Note 1)	$\lambda_P = 470\ \text{nm}$	-	424	-	-	348	-	-	81	-	-	26	-	Hz / ($\mu\text{W}/\text{cm}^2$)
	$\lambda_P = 524\ \text{nm}$	-	495	-	-	163	-	-	337	-	-	35	-	
	$\lambda_P = 565\ \text{nm}$	-	532	-	-	37	-	-	309	-	-	91	-	
	$\lambda_P = 640\ \text{nm}$	-	578	-	-	17	-	-	29	-	-	550	-	
Saturation Irradiance (See Note 2)	$\lambda_P = 470\ \text{nm}$	-	1410	-	-	1720	-	-	-	-	-	-	-	($\mu\text{W}/\text{cm}^2$)
	$\lambda_P = 524\ \text{nm}$	-	1210	-	-	-	-	-	1780	-	-	-	-	
	$\lambda_P = 565\ \text{nm}$	-	1130	-	-	-	-	-	1940	-	-	-	-	
	$\lambda_P = 640\ \text{nm}$	-	1040	-	-	-	-	-	-	-	-	1090	-	
Illuminance Responsivity (R_v) (See Note 3)	$\lambda_P = 470\ \text{nm}$	-	565	-	-	464	-	-	108	-	-	35	-	Hz / Lux
	$\lambda_P = 524\ \text{nm}$	-	95	-	-	31	-	-	65	-	-	7	-	
	$\lambda_P = 565\ \text{nm}$	-	89	-	-	6	-	-	52	-	-	15	-	
	$\lambda_P = 640\ \text{nm}$	-	373	-	-	11	-	-	19	-	-	355	-	
Nonlinearity (See Note 4)	$(f_o) = 0$ to 5 kHz	-	± 0.1	-	-	± 0.1	-	-	± 0.1	-	-	± 0.1	-	% Full Scale
	$(f_o) = 0$ to 50 kHz	-	± 0.2	-	-	± 0.2	-	-	± 0.2	-	-	± 0.2	-	
	$(f_o) = 0$ to 500 kHz	-	± 0.5	-	-	± 0.5	-	-	± 0.5	-	-	± 0.5	-	

Notes:

1. Irradiance Responsivity (R_e) is measured over the range from Frequency 0 to 5 kHz.
2. Saturation Irradiance—(Full-Scale Frequency) / (Irradiance Responsivity)
3. Illuminance Responsivity is calculated from the Irradiance Responsivity using the appropriate wavelength LED.
4. Nonlinearity is defined as the deviation of the Output Frequency utilizing a straight line between 0 and full scale and is expressed as a percent of full scale.

OPTEK reserves the right to make changes at any time in order to improve design and to supply the best product possible.

OPB780-Kit

Color Sensor Evaluation Kit



One of the critical parts of the **OPB780Z** is the **LED**. It is very important to understand its characteristics relative to forward current and temperature. The below chart shows how the forward current of the LED changes the Chromatic coordinates.

As can be seen, increasing the forward current of the LED lowers the “Y” value while minimally changing the “X” value. The projected most optimum light (equivalent to sun light at 12 noon with no contaminates in the air) has both “X” and “Y” chromatic values of 1/3. Chromatic numbers below 1/3 consist of more Blue or Green wavelengths and numbers above 1/3 consist of more Red or Yellow wavelengths. As can be seen a forward current of approximately 4 mA would provide the most optimum “Y” value.

Forward Current vs Chromaticity Coordinate

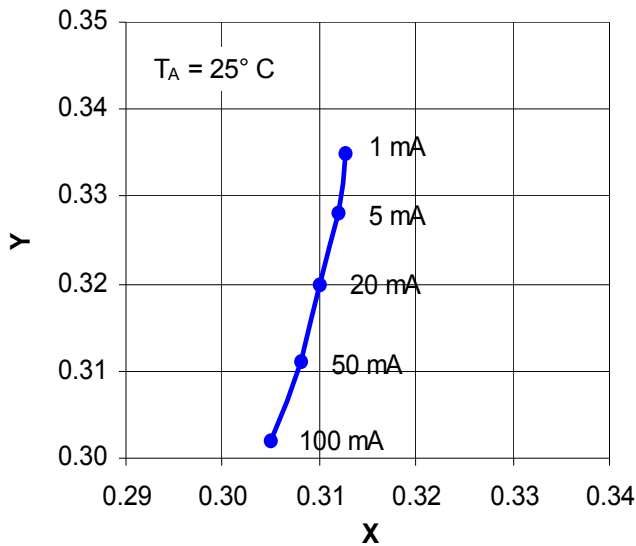

Ambient Temperature vs Chromaticity Coordinate

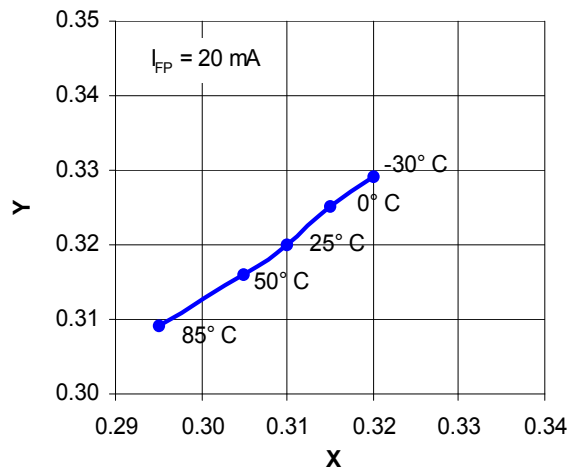

The graphs show the change in chromaticity vs temperature. As the temperature reduces the “X” value moves closer toward the optimum (1/3) value. In conclusion, the lower the forward current and the cooler the temperature, the closer the LED transmits to the optimum chromatic values of “X”=1/3 and “Y”=1/3.

In order to provide sufficient light levels and the best color resolution, the white LED should be driven with at least 20 mA of forward current and operated at room temperatures (approx. 25°C). These conditions result in chromatic ranges of about “X”=0.31 and “Y”=0.32.

The responsivity of the each diode group is dependent on the angular position of the device to the object. The graphs showing the typical variance of the Output frequency of the device vs both Azimuth (twist) and Zenith (bend) are shown in the two graphs.

OPTEK reserves the right to make changes at any time in order to improve design and to supply the best product possible.

OPB780-Kit

Color Sensor Evaluation Kit

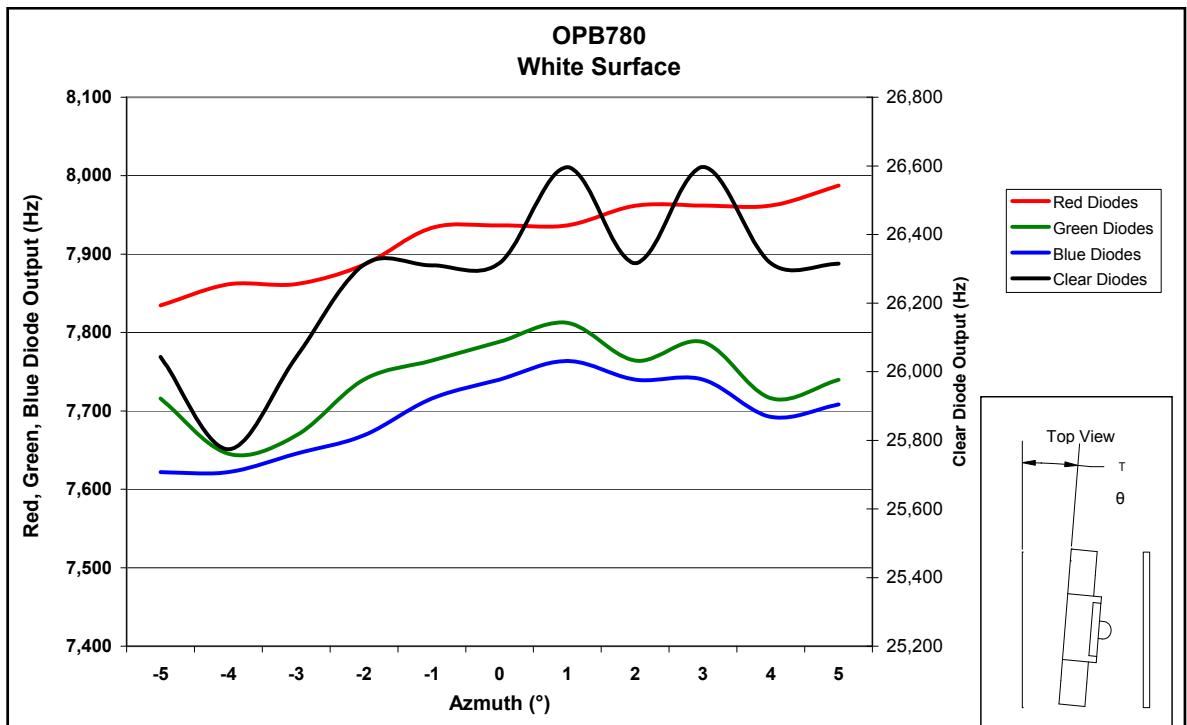
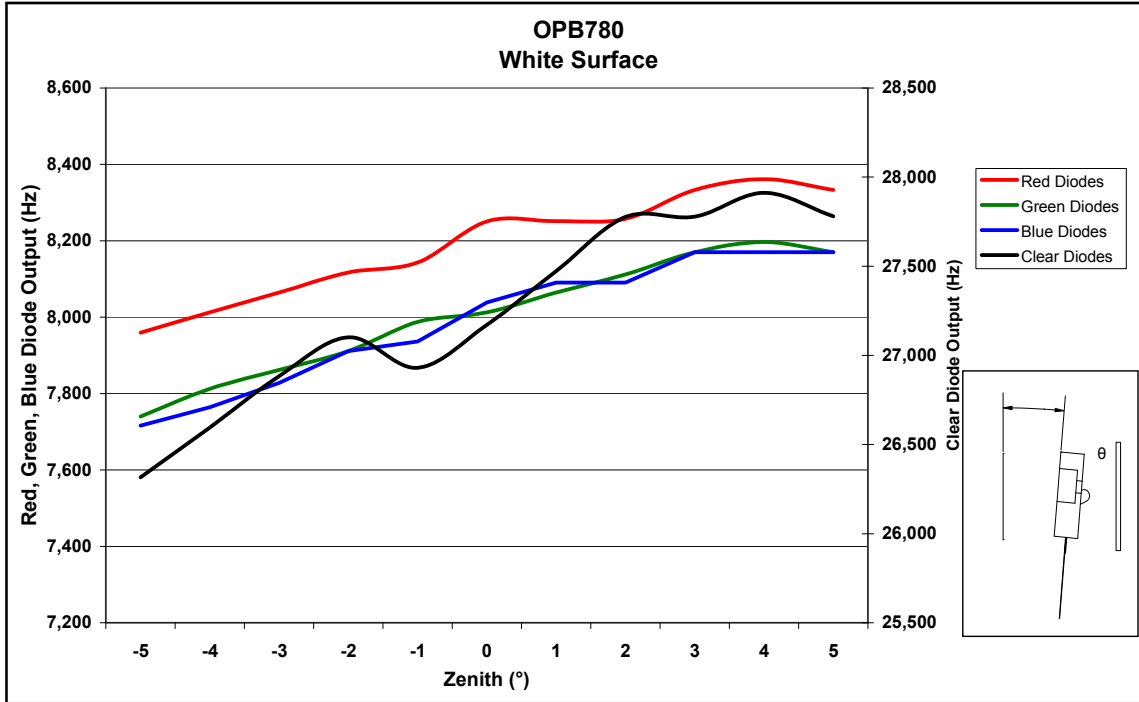

OPTEK reserves the right to make changes at any time in order to improve design and to supply the best product possible.

OPB780-Kit

Color Sensor Evaluation Kit



The distance of the object from the sensor is a critical parameter with typical frequency responses for each Diode and filter combination graphed below.

Clear Diode Filter Output Frequency vs Distance

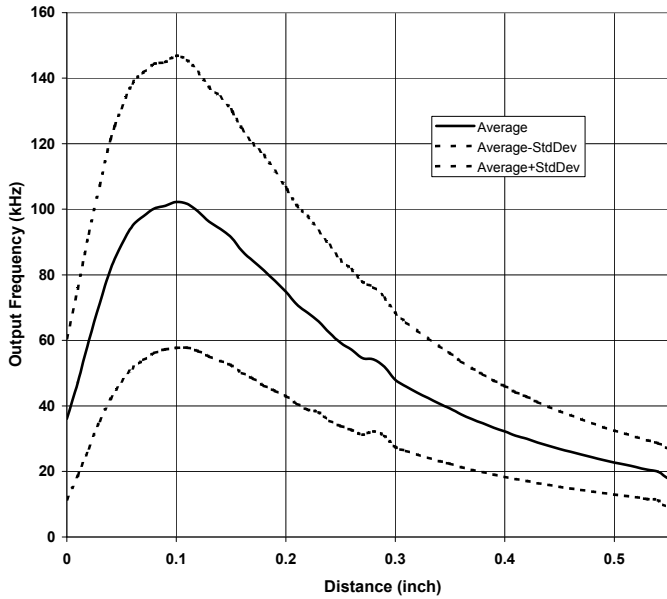

Red Diode Filters Output Frequency vs Distance

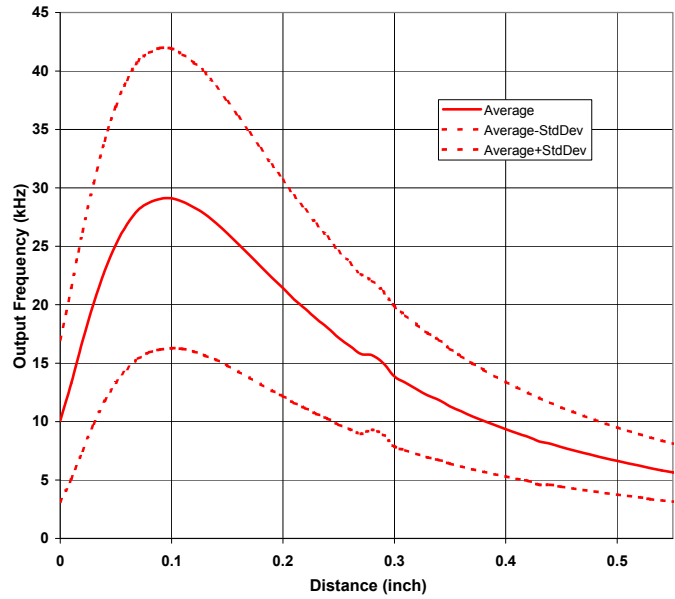

Blue Diode Filters Output Frequency vs Distance

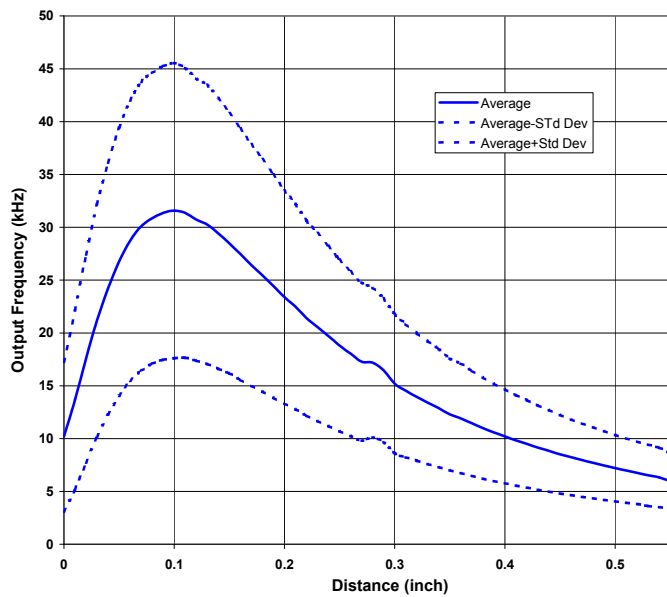

Green Diode Filter Output Frequency vs Distance

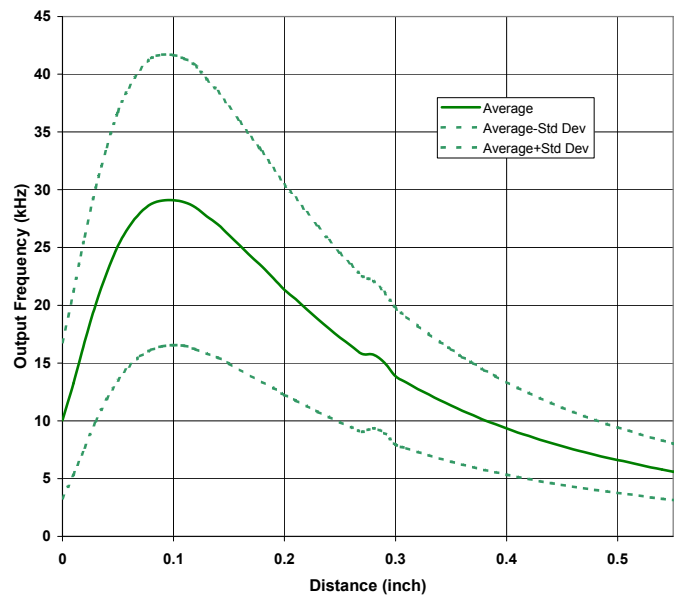

OPTEK reserves the right to make changes at any time in order to improve design and to supply the best product possible.

OPB780 Color Sensor.
(D=0.1 inches from lens tip, White Target)

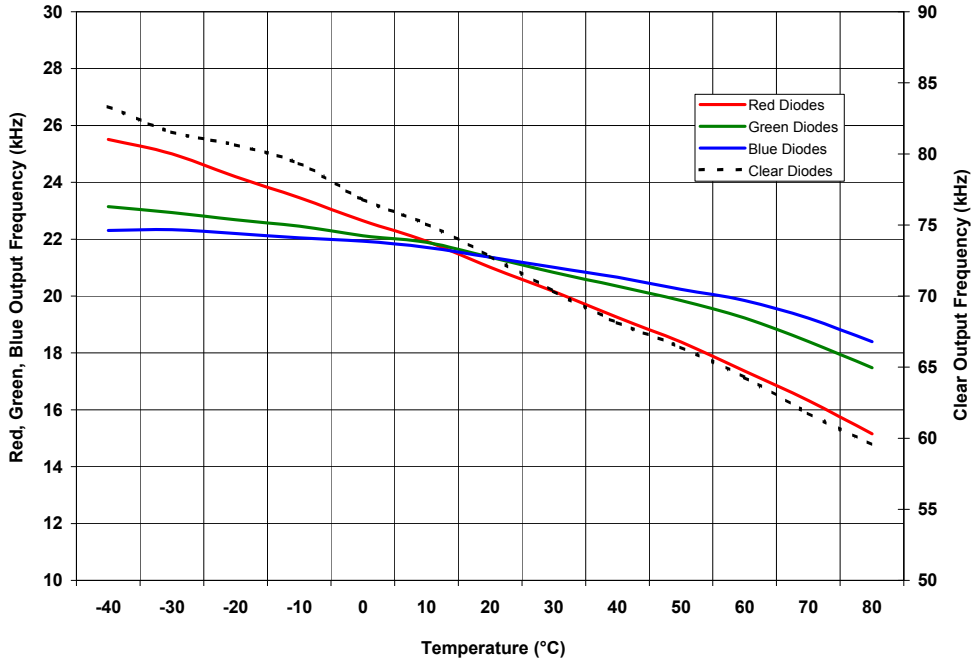

LED Relative Luminosity vs Ambient Temperature

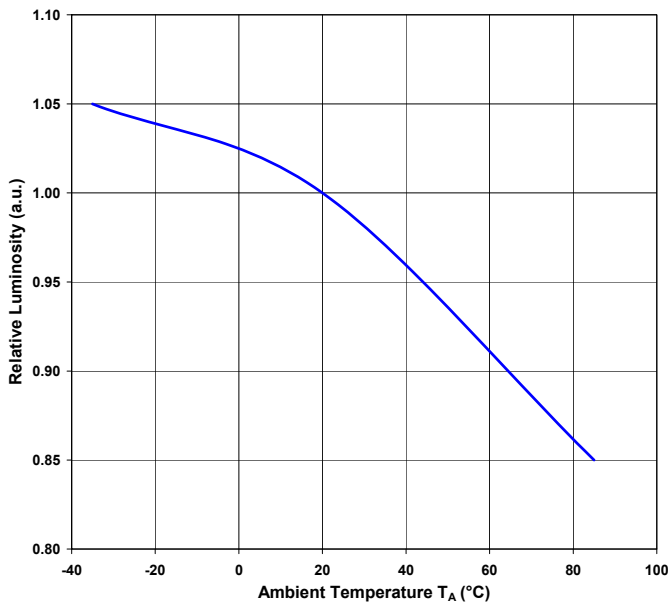

Ambient Temperature vs Forward Voltage

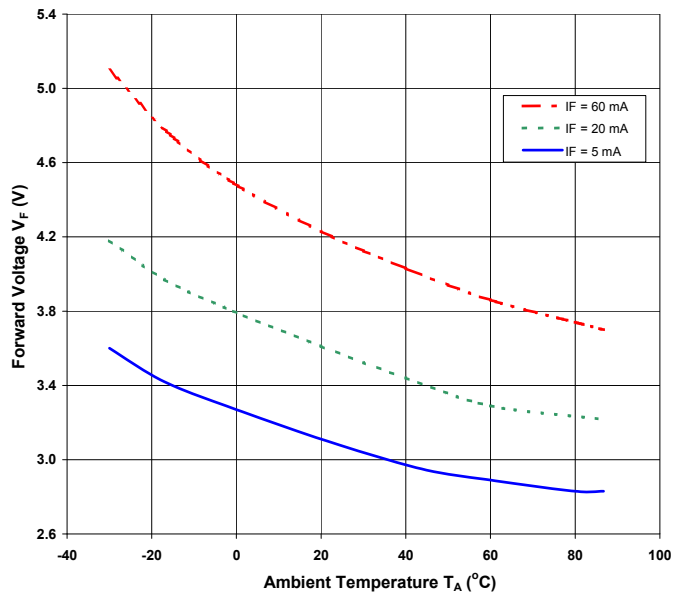

OPTEK reserves the right to make changes at any time in order to improve design and to supply the best product possible.

OPB780-Kit

Color Sensor Evaluation Kit

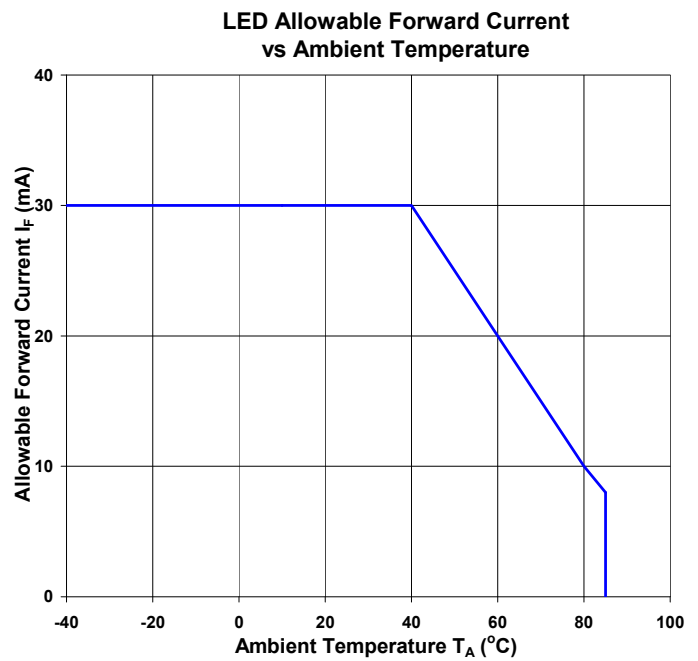
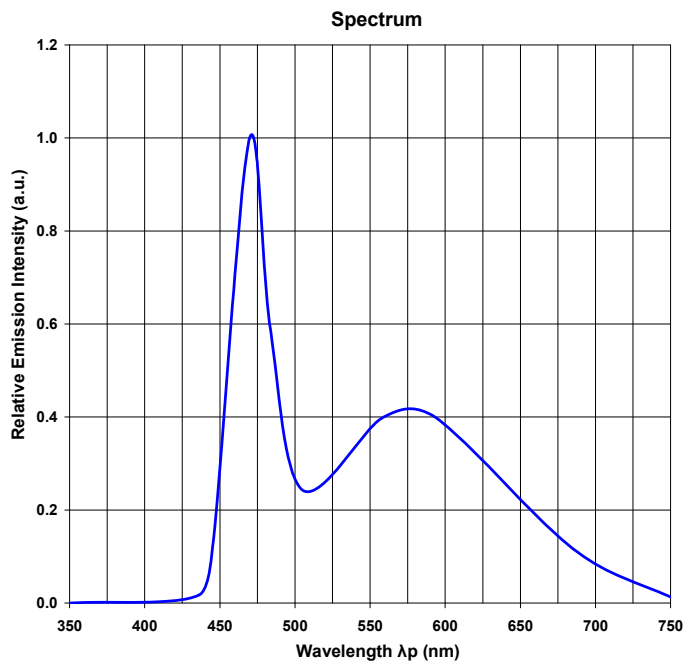
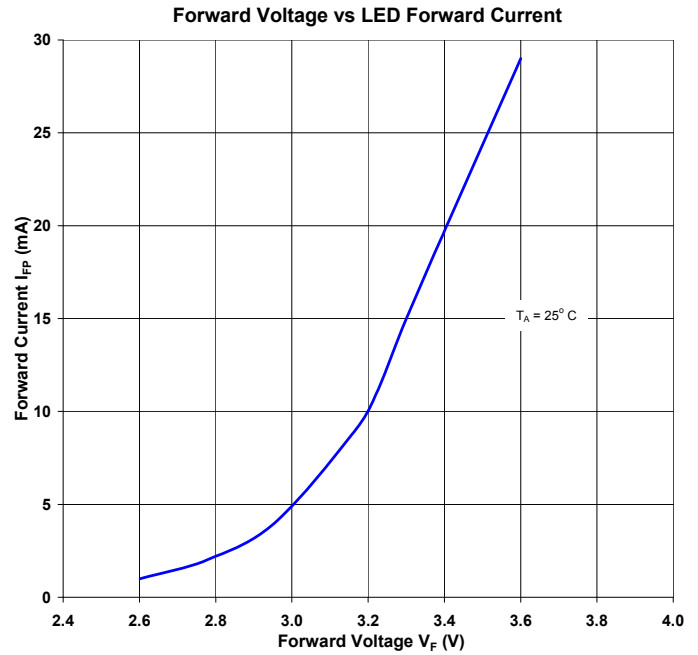
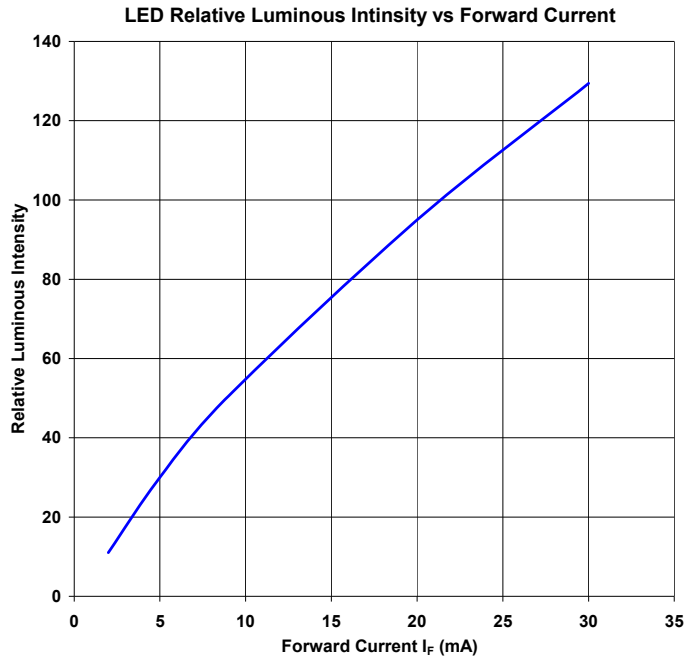

OPTEK reserves the right to make changes at any time in order to improve design and to supply the best product possible.

Power Regulation

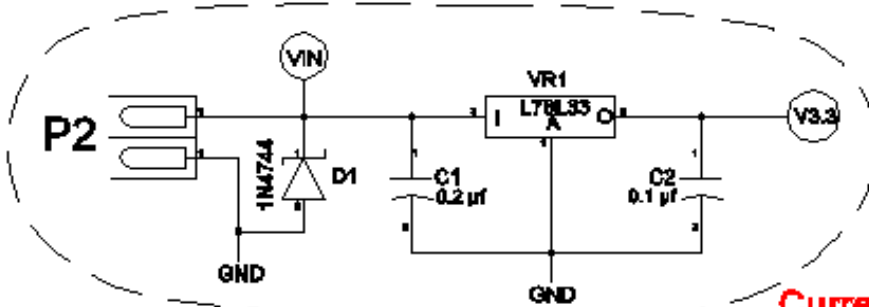

Possible Hook-up Schematic

Current Source

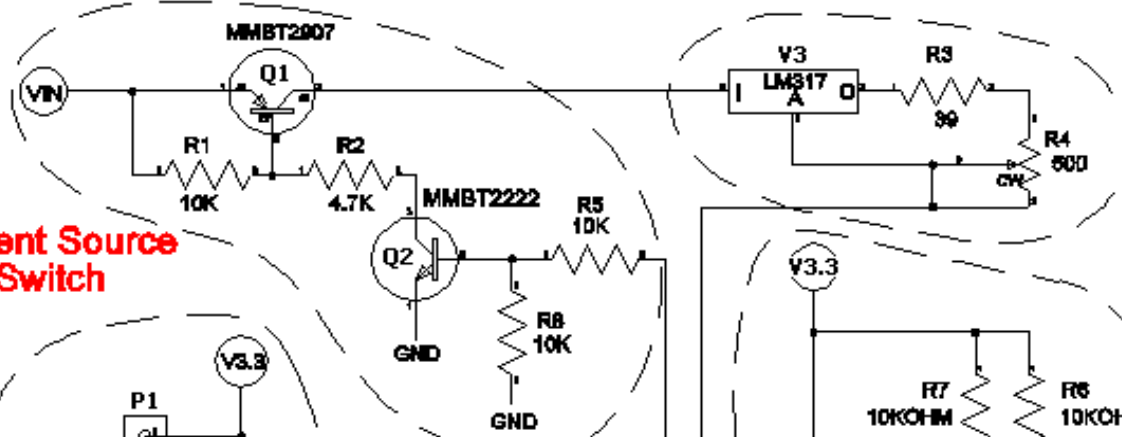

Current Source Switch

Programming Connection

OPB780 Connection

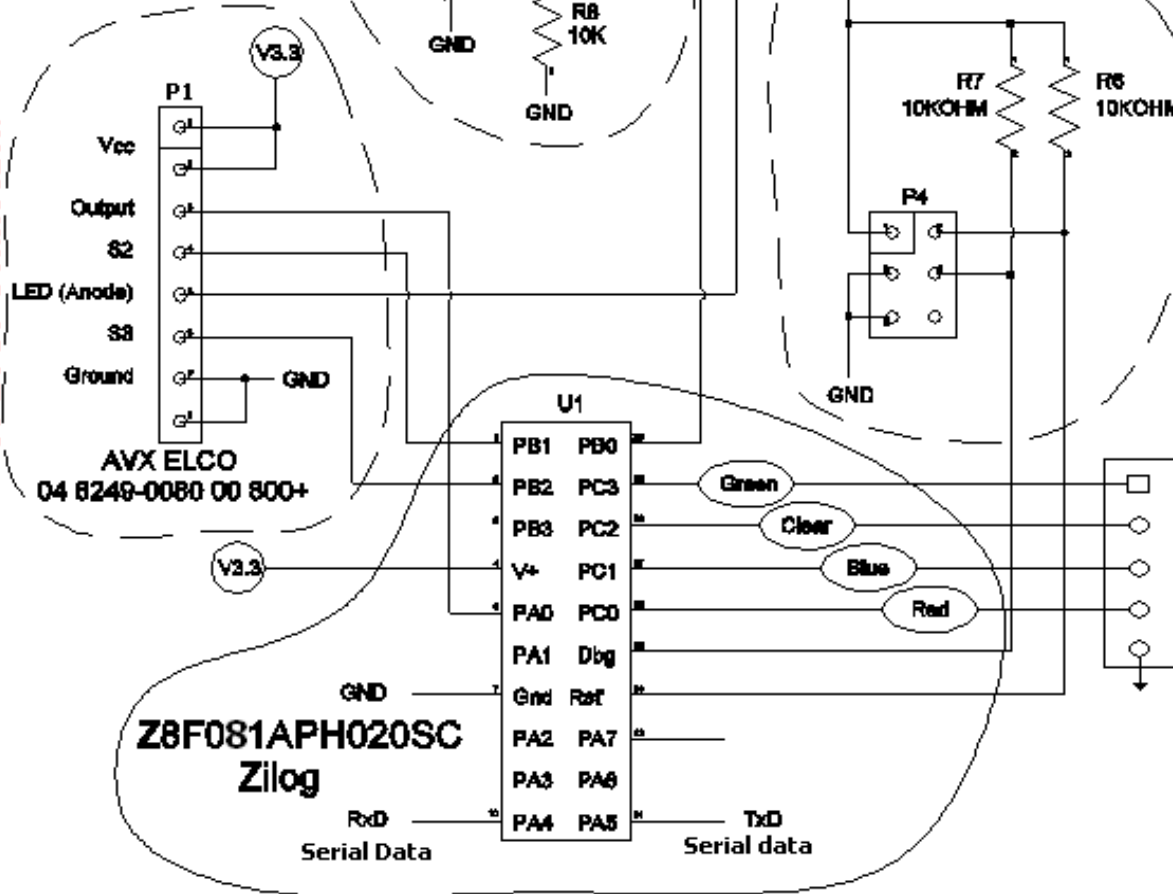

Micro-Controller

OPTEK Technology reserves the right to make changes at any time in order to improve design and to supply the best product possible.