



MM3Z series

Voltage regulator diodes

Rev. 2 — 21 February 2023

Product data sheet

1. General description

General-purpose Zener diodes in a very small SOD323 (SC-76) Surface-Mounted Device (SMD) plastic package.

2. Features and benefits

- Non-repetitive peak reverse power dissipation: ≤ 40 W
- Total power dissipation: ≤ 300 mW
- Tolerance series: Approximately $\pm 5\%$
- Wide working voltage range: nominal 2.4 V to 75 V
- Low differential resistance

3. Applications

- General regulation functions

4. Quick reference data

Table 1. Quick reference data

Symbol	Parameter	Conditions	Min	Typ	Max	Unit
V_F	forward voltage	$I_F = 100$ mA [1]	-	-	1.1	V
P_{ZSM}	non-repetitive peak reverse power dissipation	[2]	-	-	40	W

[1] Pulse test: $t_p \leq 300$ μ s; $\delta \leq 0.02$

[2] $t_p = 100$ μ s; square wave; $T_j = 25$ °C before surge

5. Pinning information

Table 2. Pinning

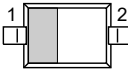
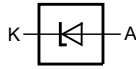
Pin	Symbol	Description	Simplified outline	Graphic symbol
1	K	cathode[1]		 006aaa152
2	A	anode		

[1] The marking bar indicates the cathode.

6. Ordering information

Table 3. Ordering information

Type number	Package		
	Name	Description	Version
MM3Z2V4T1G to MM3Z75VT1G ^[1]	SC-76	plastic surface-mounted package; 2 leads	SOD323

[1] The series consists of 37 types with nominal working voltages from 2.4 V to 75 V.

7. Marking

Table 4. Marking Codes

Type number	Marking Code	Type number	Marking Code
MM3Z2V4T1G	X8	MM3Z15VT1G	VV
MM3Z2V7T1G	X9	MM3Z16VT1G	VZ
MM3Z3V0T1G	XT	MM3Z18VT1G	X4
MM3Z3V3T1G	XW	MM3Z20VT1G	XC
MM3Z3V6T1G	XZ	MM3Z22VT1G	XG
MM3Z3V9T1G	ME	MM3Z24VT1G	XM
MM3Z4V3T1G	MM	MM3Z27VT1G	DK
MM3Z4V7T1G	MS	MM3Z30VT1G	DL
MM3Z5V1T1G	MW	MM3Z33VT1G	DM
MM3Z5V6T1G	LF	MM3Z36VT1G	DN
MM3Z6V2T1G	LL	MM3Z39VT1G	DP
MM3Z6V8T1G	LR	MM3Z43VT1G	DR
MM3Z7V5T1G	LV	MM3Z47VT1G	DS
MM3Z8V2T1G	LZ	MM3Z51VT1G	DT
MM3Z9V1T1G	CU	MM3Z56VT1G	DU
MM3Z10VT1G	VA	MM3Z62VT1G	DV
MM3Z11VT1G	VE	MM3Z68VT1G	DW
MM3Z12VT1G	VK	MM3Z75VT1G	DX
MM3Z13VT1G	VP	-	-

8. Limiting values

Table 5. Limiting values

In accordance with the Absolute Maximum Rating System (IEC 60134).

Symbol	Parameter	Conditions	Min	Max	Unit
I_F	forward current		-	200	mA
P_{ZSM}	non-repetitive peak reverse power dissipation	$t_p = 100 \mu\text{s}$; square wave; $T_{amb} = 25 \text{ }^\circ\text{C}$; prior to surge	-	40	W
P_{tot}	total power dissipation	$T_{amb} = 25 \text{ }^\circ\text{C}$	[1]	300	mW
T_j	junction temperature		-	150	$^\circ\text{C}$
T_{amb}	ambient temperature		-55	+150	$^\circ\text{C}$
T_{stg}	storage temperature		-65	+150	$^\circ\text{C}$

[1] Device mounted on an FR4 Printed-Circuit Board (PCB), single-sided copper, tin-plated and standard footprint.

9. Thermal characteristics

Table 6. Thermal characteristics

Symbol	Parameter	Conditions	Min	Typ	Max	Unit
$R_{th(j-a)}$	thermal resistance from junction to ambient	in free air [1]	-	-	415	K/W
$R_{th(j-sp)}$	thermal resistance from junction to solder point	[2]	-	-	110	K/W

[1] Device mounted on an FR4 Printed-Circuit Board (PCB), single-sided copper, tin-plated and standard footprint.

[2] Soldering point of cathode tab

10. Characteristics

Table 7. Electrical characteristics

$T_j = 25 \text{ }^\circ\text{C}$ unless otherwise specified.

Symbol	Parameter	Conditions	Max	Unit	
V_F	forward voltage	$I_F = 10 \text{ mA}$	[1]	0.9	V
		$I_F = 100 \text{ mA}$	[1]	1.1	V

[1] Pulse test: $t_p \leq 300 \mu\text{s}$; $\delta \leq 0.02$

Table 8. Electrical characteristics per type: MM3Z2V4T1G to MM3Z24VT1G

 $T_j = 25\text{ °C}$ unless otherwise specified.

MM3ZxxxT1G	Working voltage V_Z (V)		Reverse current I_R (μA)		Differential resistance r_{diff} (Ω)		Temperature coefficient S_Z (mV/K)		Diode capacitance C_d (pF)[1]
	$I_Z = 5\text{ mA}$		Max	V_R (V)	$I_Z = 0.5\text{ mA}$	$I_Z = 5\text{ mA}$	$I_Z = 5\text{ mA}$		
	Min	Max			Max	Max	Min	Max	
2V4	2.30	2.60	50.0	1.0	1000	100	-3.5	0	450
2V7	2.50	2.90	20.0	1.0	1000	100	-3.5	0	440
3V0	2.80	3.20	10.0	1.0	1000	95	-3.5	0	425
3V3	3.10	3.50	5.0	1.0	1000	95	-3.5	0	410
3V6	3.40	3.80	5.0	1.0	1000	90	-3.5	0	390
3V9	3.70	4.10	3.0	1.0	1000	90	-3.5	0	370
4V3	4.01	4.48	3.0	1.0	1000	90	-3.5	0	350
4V7	4.42	4.90	2.0	1.0	800	80	-3.5	0.2	325
5V1	4.84	5.37	2.0	1.5	250	60	-2.7	1.2	300
5V6	5.31	5.92	1.0	2.5	100	40	-2.0	2.5	275
6V2	5.86	6.53	0.5	3.0	80	30	0.4	3.7	250
6V8	6.47	7.14	0.5	3.5	60	20	1.2	4.5	215
7V5	7.06	7.84	0.5	4.0	60	10	2.5	5.3	170
8V2	7.76	8.64	0.5	5.0	60	10	3.2	6.2	150
9V1	8.56	9.55	0.5	6.0	60	10	3.8	7.0	120
10V	9.45	10.55	0.1	7.0	60	10	4.5	8.0	110
11V	10.44	11.56	0.1	8.0	60	10	5.4	9.0	108
12V	11.42	12.60	0.1	9.0	80	10	6.0	10.0	105
13V	12.47	13.96	0.1	10.0	80	10	7.0	11.0	103
15V	13.84	15.52	0.05	11.0	80	15	9.2	13.0	99
16V	15.37	17.09	0.05	12.0	80	20	10.4	14.0	97
18V	16.94	19.03	0.05	13.0	80	20	12.4	16.0	93
20V	18.86	21.08	0.05	15.0	100	20	14.4	18.0	88
22V	20.88	23.17	0.05	17.0	100	25	16.4	20.0	84
24V	22.93	25.57	0.05	19.0	120	30	18.4	22.0	80

[1] $f = 1\text{ MHz}$; $V_R = 0\text{ V}$

Table 9. Electrical characteristics per type: MM3Z27VT1G to MM3Z75VT1G

 $T_j = 25\text{ °C}$ unless otherwise specified.

MM3ZxxxT1G	Working voltage V_Z (V)		Reverse current I_R (μ A)		Differential resistance r_{diff} (Ω)		Temperature coefficient S_Z (mV/K)		Diode capacitance C_d (pF)[1]
	$I_Z = 2\text{ mA}$		Max	V_R (V)	$I_Z = 0.5\text{ mA}$	$I_Z = 2\text{ mA}$	$I_Z = 2\text{ mA}$		
	Min	Max			Max	Max	Min	Max	
27V	25.10	28.90	0.05	18.9	300	80	21.4	25.3	50
30V	28.00	32.00	0.05	21.0	300	80	24.4	29.4	50
33V	31.00	35.00	0.05	23.1	325	80	27.4	33.4	45
36V	34.00	38.00	0.05	25.2	350	90	30.4	37.4	45
39V	37.00	41.00	0.05	27.3	350	130	33.4	41.2	45
43V	40.00	46.00	0.05	30.1	375	150	37.6	46.6	40
47V	44.00	50.00	0.05	32.9	375	170	42.0	51.8	40
51V	48.00	54.00	0.05	35.7	400	180	46.6	57.2	40
56V	52.00	60.00	0.05	39.2	425	200	52.2	63.8	40
62V	58.00	66.00	0.05	43.4	450	215	58.8	71.6	35
68V	64.00	72.00	0.05	47.6	475	240	65.6	79.8	35
75V	70.00	79.00	0.05	52.5	500	255	73.4	88.6	35

[1] $f = 1\text{ MHz}$; $V_R = 0\text{ V}$

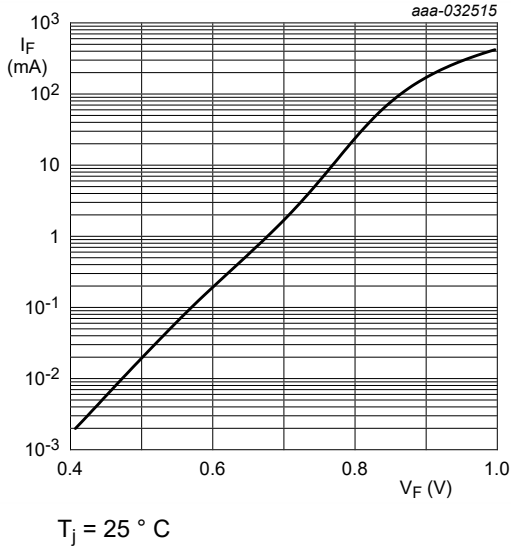

Fig. 1. Forward current as a function of forward voltage; typical values (MM3Z2V4T1G)

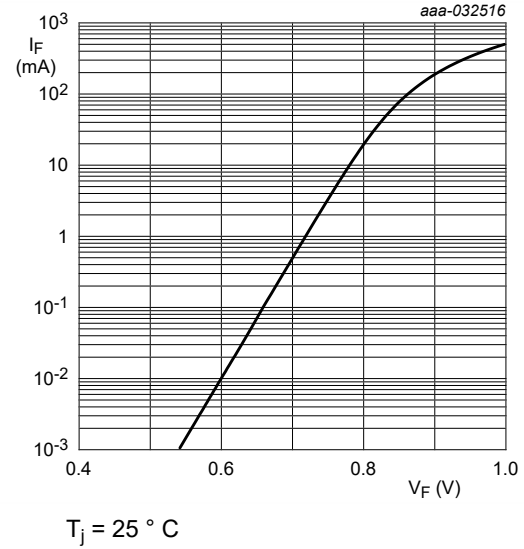

Fig. 2. Forward current as a function of forward voltage; typical values (MM3Z6V8T1G)

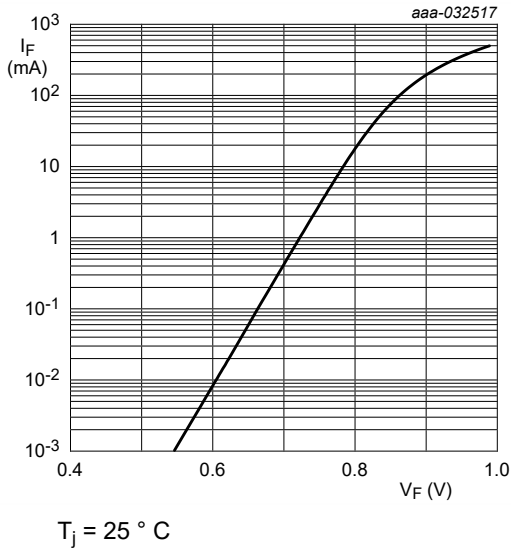

Fig. 3. Forward current as a function of forward voltage; typical values (MM3Z7V5T1G)

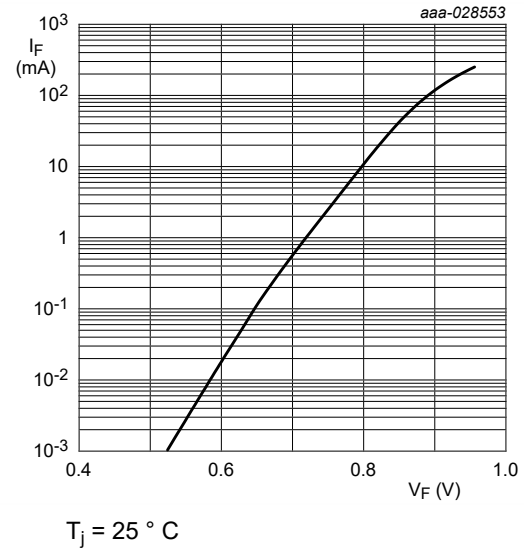
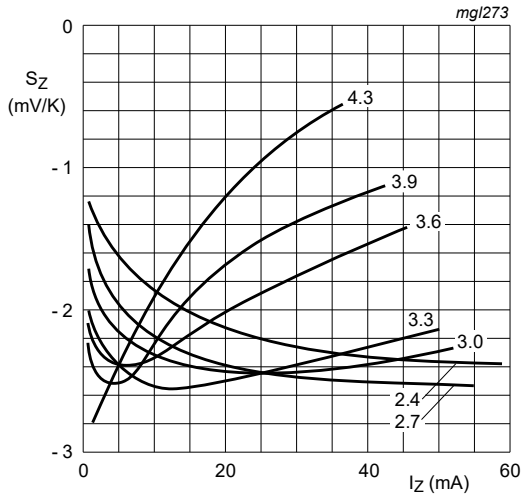
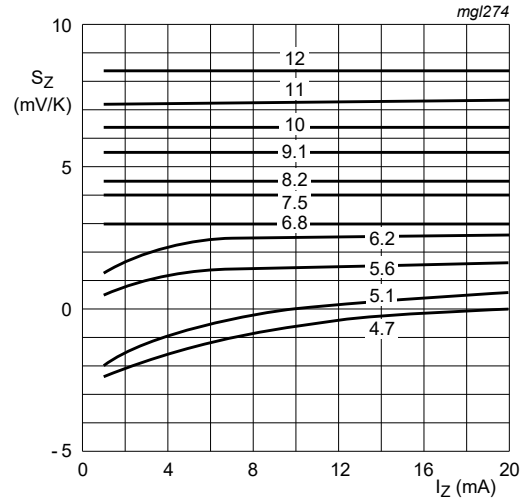

Fig. 4. Forward current as a function of forward voltage; typical values (MM3Z75VT1G)



$T_j = 25\text{ }^\circ\text{C}$ to $150\text{ }^\circ\text{C}$
 $V_Z = 2.4\text{ V}$ to 4.3 V

Fig. 5. Temperature coefficient as a function of working current; typical values (MM3Z2V4T1G to 4V3T1G)



$T_j = 25\text{ }^\circ\text{C}$ to $150\text{ }^\circ\text{C}$
 $V_Z = 4.7\text{ V}$ to 12 V

Fig. 6. Temperature coefficient as a function of working current; typical values (MM3Z4V7T1G to 12VT1G)

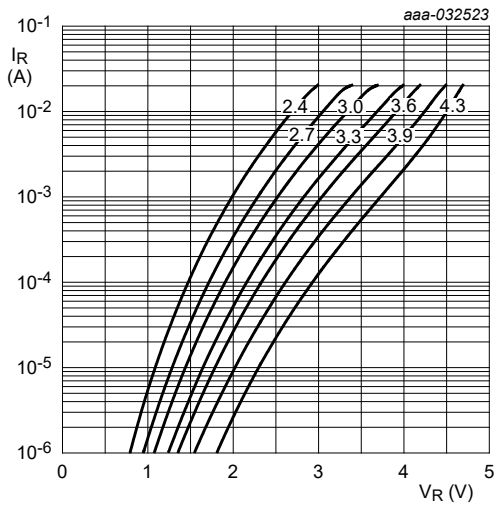

$T_j = 25\text{ }^\circ\text{C}$

Fig. 7. Reverse current as a function of reverse voltage; typical values (MM3Z2V4T1G to 4V3T1G)

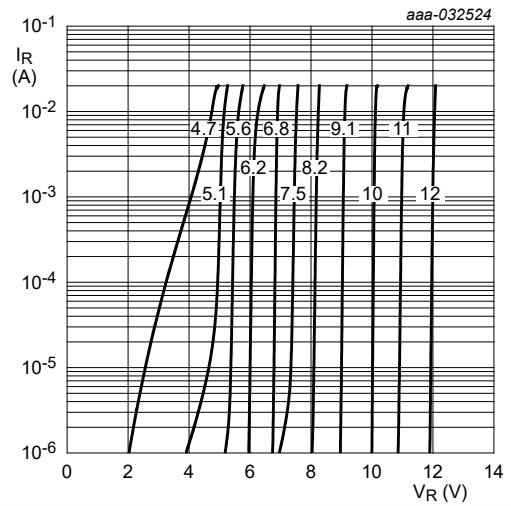

$T_j = 25\text{ }^\circ\text{C}$

Fig. 8. Reverse current as a function of reverse voltage; typical values (MM3Z4V7T1G to 12VT1G)

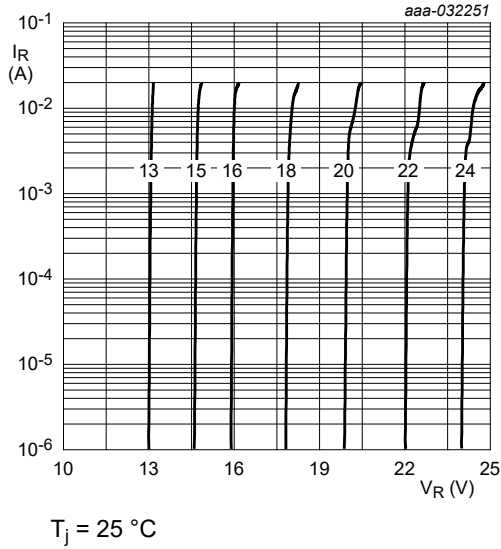

Fig. 9. Reverse current as a function of reverse voltage; typical values (MM3Z13VT1G to 24VT1G)

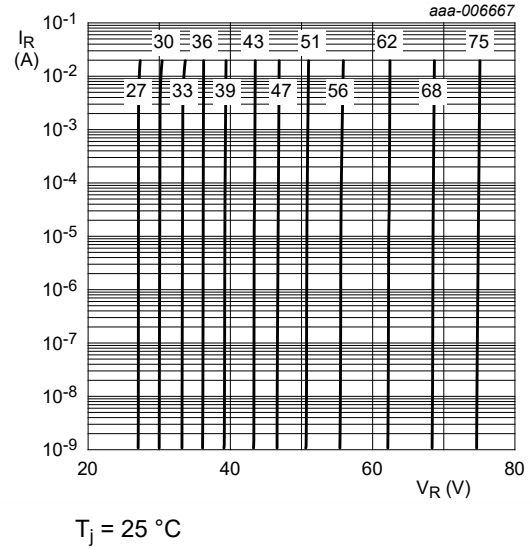

Fig. 10. Reverse current as a function of reverse voltage; typical values (MM3Z27VT1G to 75VT1G)

11. Package outline

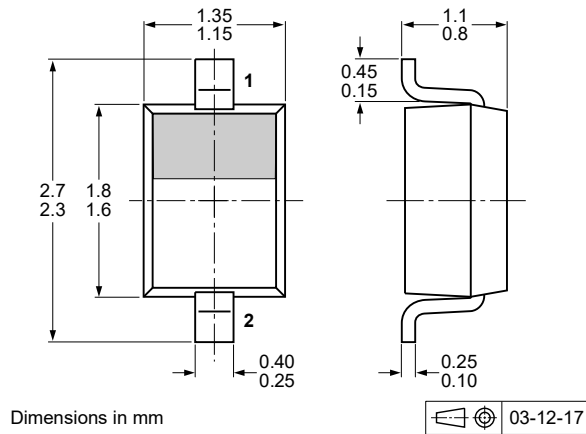
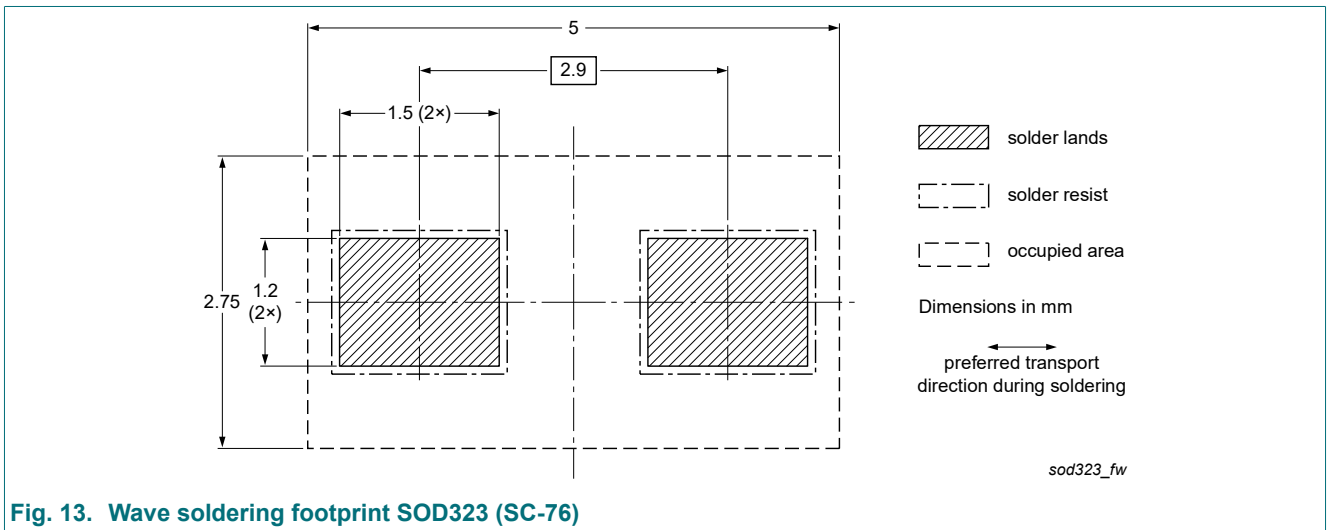
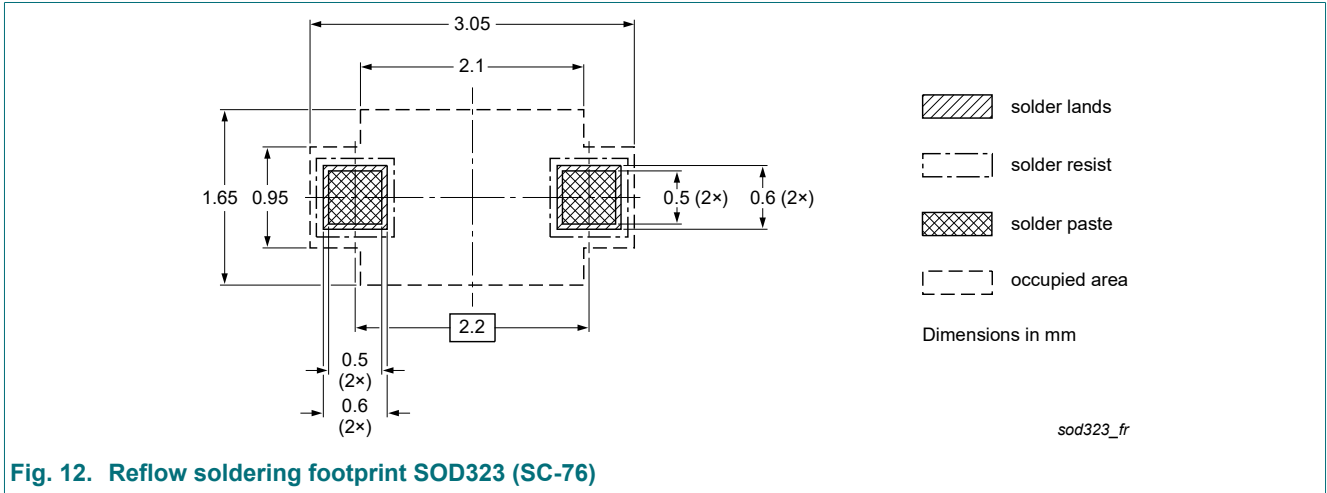

Fig. 11. Package outline SOD323 (SC-76)

12. Soldering



13. Revision history

Table 10. Revision history

Document ID	Release date	Data sheet status	Change notice	Supersedes
MM3Z_SER v.2	20230221	Product data sheet	-	MM3Z_SER v.1
Modifications:	• Limiting values: Tolerance changed			
MM3Z_SER v.1	20210407	Product data sheet	-	-

14. Legal information

Data sheet status

Document status [1][2]	Product status [3]	Definition
Objective [short] data sheet	Development	This document contains data from the objective specification for product development.
Preliminary [short] data sheet	Qualification	This document contains data from the preliminary specification.
Product [short] data sheet	Production	This document contains the product specification.

- [1] Please consult the most recently issued document before initiating or completing a design.
- [2] The term 'short data sheet' is explained in section "Definitions".
- [3] The product status of device(s) described in this document may have changed since this document was published and may differ in case of multiple devices. The latest product status information is available on the internet at <https://www.nexperia.com>.

Definitions

Draft — The document is a draft version only. The content is still under internal review and subject to formal approval, which may result in modifications or additions. Nexperia does not give any representations or warranties as to the accuracy or completeness of information included herein and shall have no liability for the consequences of use of such information.

Short data sheet — A short data sheet is an extract from a full data sheet with the same product type number(s) and title. A short data sheet is intended for quick reference only and should not be relied upon to contain detailed and full information. For detailed and full information see the relevant full data sheet, which is available on request via the local Nexperia sales office. In case of any inconsistency or conflict with the short data sheet, the full data sheet shall prevail.

Product specification — The information and data provided in a Product data sheet shall define the specification of the product as agreed between Nexperia and its customer, unless Nexperia and customer have explicitly agreed otherwise in writing. In no event however, shall an agreement be valid in which the Nexperia product is deemed to offer functions and qualities beyond those described in the Product data sheet.

Disclaimers

Limited warranty and liability — Information in this document is believed to be accurate and reliable. However, Nexperia does not give any representations or warranties, expressed or implied, as to the accuracy or completeness of such information and shall have no liability for the consequences of use of such information. Nexperia takes no responsibility for the content in this document if provided by an information source outside of Nexperia.

In no event shall Nexperia be liable for any indirect, incidental, punitive, special or consequential damages (including - without limitation - lost profits, lost savings, business interruption, costs related to the removal or replacement of any products or rework charges) whether or not such damages are based on tort (including negligence), warranty, breach of contract or any other legal theory.

Notwithstanding any damages that customer might incur for any reason whatsoever, Nexperia's aggregate and cumulative liability towards customer for the products described herein shall be limited in accordance with the Terms and conditions of commercial sale of Nexperia.

Right to make changes — Nexperia reserves the right to make changes to information published in this document, including without limitation specifications and product descriptions, at any time and without notice. This document supersedes and replaces all information supplied prior to the publication hereof.

Suitability for use — Nexperia products are not designed, authorized or warranted to be suitable for use in life support, life-critical or safety-critical systems or equipment, nor in applications where failure or malfunction of an Nexperia product can reasonably be expected to result in personal

injury, death or severe property or environmental damage. Nexperia and its suppliers accept no liability for inclusion and/or use of Nexperia products in such equipment or applications and therefore such inclusion and/or use is at the customer's own risk.

Quick reference data — The Quick reference data is an extract of the product data given in the Limiting values and Characteristics sections of this document, and as such is not complete, exhaustive or legally binding.

Applications — Applications that are described herein for any of these products are for illustrative purposes only. Nexperia makes no representation or warranty that such applications will be suitable for the specified use without further testing or modification.

Customers are responsible for the design and operation of their applications and products using Nexperia products, and Nexperia accepts no liability for any assistance with applications or customer product design. It is customer's sole responsibility to determine whether the Nexperia product is suitable and fit for the customer's applications and products planned, as well as for the planned application and use of customer's third party customer(s). Customers should provide appropriate design and operating safeguards to minimize the risks associated with their applications and products.

Nexperia does not accept any liability related to any default, damage, costs or problem which is based on any weakness or default in the customer's applications or products, or the application or use by customer's third party customer(s). Customer is responsible for doing all necessary testing for the customer's applications and products using Nexperia products in order to avoid a default of the applications and the products or of the application or use by customer's third party customer(s). Nexperia does not accept any liability in this respect.

Limiting values — Stress above one or more limiting values (as defined in the Absolute Maximum Ratings System of IEC 60134) will cause permanent damage to the device. Limiting values are stress ratings only and (proper) operation of the device at these or any other conditions above those given in the Recommended operating conditions section (if present) or the Characteristics sections of this document is not warranted. Constant or repeated exposure to limiting values will permanently and irreversibly affect the quality and reliability of the device.

Terms and conditions of commercial sale — Nexperia products are sold subject to the general terms and conditions of commercial sale, as published at <http://www.nexperia.com/profile/terms>, unless otherwise agreed in a valid written individual agreement. In case an individual agreement is concluded only the terms and conditions of the respective agreement shall apply. Nexperia hereby expressly objects to applying the customer's general terms and conditions with regard to the purchase of Nexperia products by customer.

No offer to sell or license — Nothing in this document may be interpreted or construed as an offer to sell products that is open for acceptance or the grant, conveyance or implication of any license under any copyrights, patents or other industrial or intellectual property rights.

Export control — This document as well as the item(s) described herein may be subject to export control regulations. Export might require a prior authorization from competent authorities.

Non-automotive qualified products — Unless this data sheet expressly states that this specific Nexperia product is automotive qualified, the product is not suitable for automotive use. It is neither qualified nor tested in accordance with automotive testing or application requirements. Nexperia accepts no liability for inclusion and/or use of non-automotive qualified products in automotive equipment or applications.

In the event that customer uses the product for design-in and use in automotive applications to automotive specifications and standards, customer (a) shall use the product without Nexperia's warranty of the product for such automotive applications, use and specifications, and (b) whenever customer uses the product for automotive applications beyond Nexperia's specifications such use shall be solely at customer's own risk, and (c) customer fully indemnifies Nexperia for any liability, damages or failed product claims resulting from customer design and use of the product for automotive applications beyond Nexperia's standard warranty and Nexperia's product specifications.

Translations — A non-English (translated) version of a document is for reference only. The English version shall prevail in case of any discrepancy between the translated and English versions.

Trademarks

Notice: All referenced brands, product names, service names and trademarks are the property of their respective owners.

Contents

1. General description.....	1
2. Features and benefits.....	1
3. Applications.....	1
4. Quick reference data.....	1
5. Pinning information.....	1
6. Ordering information.....	2
7. Marking.....	2
8. Limiting values.....	3
9. Thermal characteristics.....	3
10. Characteristics.....	3
11. Package outline.....	8
12. Soldering.....	9
13. Revision history.....	10
14. Legal information.....	11

© Nexperia B.V. 2023. All rights reserved

For more information, please visit: <http://www.nexperia.com>

For sales office addresses, please send an email to: salesaddresses@nexperia.com

Date of release: 21 February 2023
