

THDB-HDMI

Terasic HDMI Video Daughter Board

User Manual



Chapter 1 Introduction	2
1.1 About the KIT	2
1.2 Assemble the HDMI Board.....	3
1.3 Getting Help.....	3
Chapter 2 HDMI Board.....	4
2.1 Features	4
2.2 Layout and Componets	7
2.3 Block Diagram of HDMI Signal Transmission.....	8
2.4 Block Diagram of HDMI Signal Receiving.....	10
2.5 Generate Pin Assignments	11
2.6 Pin Definition of HSTC Connector.....	13
Chapter 3 Demonstration	21
3.1 Introduction.....	21
3.2 System Requirements.....	21
3.3 Setup the Demonstration.....	22
3.4 Operation.....	23
Chapter 4 Case Study	27
4.1 Overview	27
4.2 System Function Block.....	27
4.3 NIOS Program	31
Chapter 5 Appendix	35
5.1 Revision History	35
5.2 Always Visit THDB-HDMI Webpage for Update.....	35

Chapter 1

Introduction

THDB-HDMI is a HDMI transmitter/receiver daughter board with HSTC (High Speed Terasic Connector) interface. Host boards, supporting HSTC-compliant connectors, can control the HDMI daughter board through the HSTC interface.

This THDB-HDMI kit contains complete reference designs with source code written in Verilog and C, for HDMI signal transmitting and receiving. Based on reference designs, users can easily and quickly develop their applications.

1.1 About the KIT

This section describes the package content.

The THDB-HDMI package, as shown in **Figure 1-1**, contains:

- THDB-HDMI board x 1
- System CD-ROM x 1

The CD contains technical documents of the HDMI receiver and transmitter, and one reference design for HDMI transmitting and receiving with source code.



Figure 1-1 THDB-HDMI Package

1.2 Assemble the HDMI Board

This section describes how to connect the HDMI daughter board to a main board, and use DE3 as an example.

The HDMI board connects to main boards through the HSTC interface. For DE3, the HDMI daughter board can be connected to any one of four HSTC connectors on DE3.

Figure 1-2 shows a HDMI daughter board connected to the HSTC connector of DE3. Due to high speed data rate in between, users are strongly recommended to screw the two boards together.

Note. Do not attempt to connect/remove the HDMI daughter board to/from the main board when the power is on, or the hardware could be damaged.



Figure 1-2 Connect HDMI daughter board to DE3 board

1.3 Getting Help

Here are some places to get help if you encounter any problem:

- Email to support@terasic.com
- Taiwan: +886-3-570-0880
- China : +86-27-8774-5390

Chapter 2

HDMI Board

This chapter will illustrate technical details of HDMI board. Users may modify the reference designs for various purposes accordingly.

2.1 Features

This section describes the major features of the HDMI board.

■ Board Features:

- One HSTC interface for connection purpose
- One HDMI transmitter with single transmitting port
- One HDMI receiver with dual receiving ports
- Two 2K EEPROM for storing EDID of two receiver ports separately
- Powered from 3.3V pins of HSTC connector

■ HDMI Transmitter Features:

1. HDMI 1.4 transmitter
2. Compliant with HDMI 1.3, HDMI1.4a 3D,HDCP 1.4 and DVI 1.1 specifications
3. Supporting link speeds of up to 2.25 Gbps (link clock rate of 225MHZ)
4. Supporting diverse 3D formats which are compliant with HDMI 1.4a 3D specification.
 - Supporting 3D video up to 1080P@23.98/24/30Hz,1080i@50/59.94/60/Hz
 - Supporting formats: framing packing, side-by-side(half),top-and-bottom
5. Various video input interface supporting digital video standards such as:
 - 24/30/36-bit RGB/YCbCr 4:4:4
 - 16/20/24-bit YCbCr 4:2:2
 - 8/10/12-bit YCbCr 4:2:2 (CCIR-656)
6. Bi-direction Color Space Conversion (CSC) between RGB and YCbCr color space with programmable coefficients

7. Up/down sampling between YCbCr 4:4:4 and YCbCr 4:2:2
8. Either for conversion from 12-bit/10-bit to component to 8-bit
9. Support Gammat Metadata packet
10. Digital audio input interface supporting:
 - Up to four I2S interface supporting 8-channel audio, with sample rates of 32~192 kHz and sample sizes of 16~24 bits
 - S/PDIF interface supporting PCM, Dolby Digital, DTS digital audio at up to 192kHz frame rate
 - Support for high-bit-rate (HBR) audio such as DTS-HD and Dolby TrueHD through the four I2S interface or the S/PDIF interface, with frame rates as high as 768kHz
 - Support for 8-channel DSD audio through dedicated inputs
 - Compatible with IEC 60958 and IEC 61937
 - Audio down-sampling of 2X and 4X
11. Software programmable, auto-calibrated TMDS source terminations provide for optimal source signal quality
12. Software programmable HDMI output current level
13. MCLK input is optional for audio operation. Users could opt to implement audio input interface with or without MCLK
14. Integrated pre-programmed HDCP keys
15. Purely hardware HDCP engine increasing the robustness and security of HDCP operation
16. Monitor detection through Hot Plug Detection and Receiver Termination Detection
17. Embedded full-function pattern generator
18. Intelligent, programmable power management

Table 2-1 lists supported input video format:

Table 2-1 Input video formats supported by the HDMI board

Color space	Video Format	Bus Width	Hsync/Vsync	Input Pixel Clock Frequency(MHz)							
				480i	480p	XGA	720p	1080i	SXGA	1080p	UXGA
RGB	4:4:4	24	Separate	13.5	27	65	74.25	74.25	108	148.5	162
		30/36		13.5	27	65	74.25	74.25	108	148.5	
		12/15/18	Separate	13.5	27	65	74.25	74.25			
YCbCr	4:4:4	24	Separate	13.5	27	65	74.25	74.25	108	148.5	162
		30/36		13.5	27	65	74.25	74.25	108	148.5	
		12/15/18	Separate	13.5	27	65	74.25	74.25			
	4:2:2	16/20/24	Separate	13.5	27		74.25	74.25		148.5	
			Embedded	13.5	27		74.25	74.25		148.5	

		12/15/18	Separate	27	54		148.5	148.5			
			Embedded	27	54		148.5	148.5			

■ HDMI Receiver Features:

1. Dual-Port HDMI 1.4 receiver
2. Compliant with HDMI 1.3, HDMI1.4a 3D,HDCP 1.4 and DVI 1.1 specifications
3. Supporting link speeds of up to 2.25 Gbps (link clock rate of 225MHZ)
4. Supporting diverse 3D formats which are compliant with HDMI 1.4a 3D specification.
 - Supporting 3D video up to 1080P@23.98/24/30Hz,1080i@50/59.94/60/Hz
 - Supporting formats: framing packing, side-by-side(half),top-and-bottom
5. Various video input interface supporting digital video standards such as:
 - 24/30/36-bit RGB/YCbCr 4:4:4
 - 16/20/24-bit YCbCr 4:2:2
 - 8/10/12-bit YCbCr 4:2:2 (ITU BT-656)
 - 12/15/18-bit double data rate interface (data bus width halved, clocked with both rising and falling edges) for RGB/YCbCr 4:4:4
 - 24/30/36-bit double data rate interface (full bus width, pixel clock rate halved, clocked with both rising and falling edges)
 - Input channel swap
 - MSB/LSB swap
6. Bi-direction Color Space Conversion (CSC) between RGB and YCbCr color space with programmable coefficients
7. Up/down sampling between YCbCr 4:4:4 and YCbCr 4:2:2
8. Dither for conversion from 12-bit/10-bit to component to 10-bit/8-bit
9. Support Gammat Metadata packet
10. Digital audio output interface supporting:
 - Up to four I2S interface supporting 8-channel audio, with sample rates of 32~192 kHz and sample sizes of 16~24 bits
 - S/PDIF interface supporting PCM, Dolby Digital, DTS digital audio at up to 192kHz frame rate
 - Optional support for 8-channel DSD audio up to 8 channels at 88.2kHz sample rate
 - Support for high-bit-rate (HBR) audio such as DTS-HD and Dolby TrueHD through the four I2S interface or the S/PDIF interface, with frame rates as high as 768kHz
 - Automatic audio error detection for programmable soft mute, preventing annoying harsh output sound due to audio error or hot-unplug
11. Auto-calibrated input termination impedance provides process-, voltage- and

temperature-invariant matching to the input transmission lines.

12. Integrated pre-programmed HDCP keys
13. Intelligent, programmable power management

Table 2-2 lists the supported output video formats:

Table 2-2 Output video formats supported by the HDMI board

Color space	Video Format	Bus Width	Hsync/ Vsync	Output Pixel Clock Frequency(MHz)							
				480i	480p	XGA	720p	1080i	SXGA	1080p	UXGA
RGB	4:4:4	24	Separate	13.5	27	65	74.25	74.25	108	148.5	162
		30/36		13.5	27	65	74.25	74.25	108	148.5	
		12/15/18	Separate	13.5	27	65	74.25	74.25			
YCbCr	4:4:4	24	Separate	13.5	27	65	74.25	74.25	108	148.5	162
		30/36		13.5	27	65	74.25	74.25	108	148.5	
		12/15/18	Separate	13.5	27	65	74.25	74.25			
	4:2:2	16/20/24	Separate	13.5	27		74.25	74.25		148.5	
			Embedded	13.5	27		74.25	74.25		148.5	
		12/15/18	Separate	27	54		148.5	148.5			
Embedded	27		54		148.5	148.5					

2.2 Layout and Components

The photo of the HDMI board is shown in Figure 2-1 and Figure 2-2. It indicates the location of the connectors and key components.

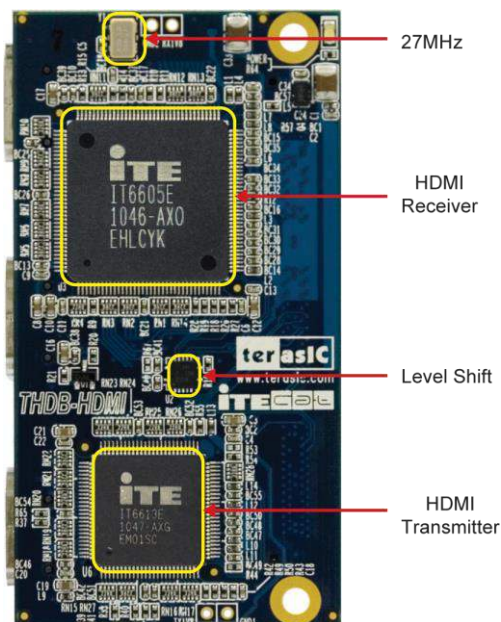

Figure 2-1 HDMI transmitter and receiver on the front of the HDMI board

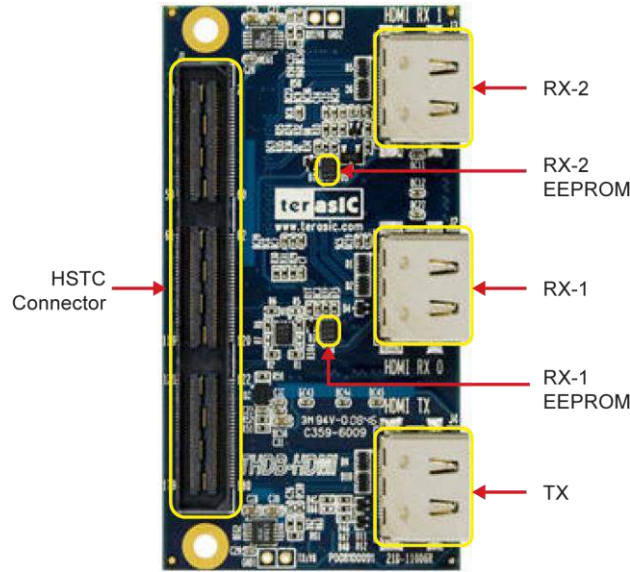

Figure 2-2 On the back of the HDMI board with HSTC connector and HDMI ports

■ **The THDB-HDMI board includes the following key components:**

- Receiver (U3)
- Receiver port 1/2 (J2/J3)
- Transmitter (U6)
- Transmitter port (J4)
- 27MHZ OSC (Y1)
- HSTC expansion connector (J1)
- Receiver I2C EEPROM (U4/U5)
- RX Regulator (REG1)
- TX Regulator (REG2)
- Level shifter (U2)

2.3 Block Diagram of HDMI Signal Transmission

This section describes the block diagram of HDMI signal transmission.

Figure 2-3 shows the block diagram of HDMI signal transmission. Please refer to the schematic included in the CD for more details. The HDMI transmitter is controlled through I2C interface, where the host works as master and the transmitter works as a slave. Because the pin PCADR is pulled low, the transmitter I2C device address is set to 0x98. Through the I2C interface, the host board can access the internal registers of transmitter to control its behavior.

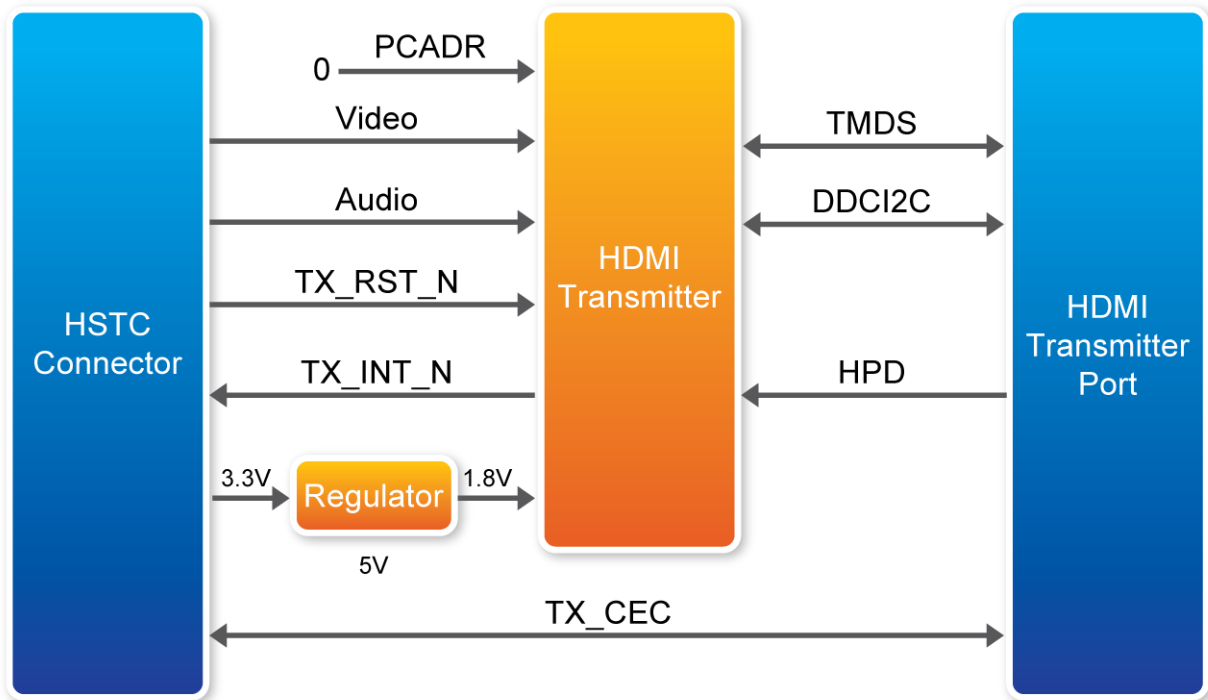

Figure 2-3 The block diagram of the HDMI signal transmission

The host can use reset pin TX_RST_N to reset the transmitter, and listen to the interrupt pin TX_INT_N to detect change of the transmitter status. When interrupt happens, the host needs to read the internal register to find out which event is triggered and perform proper actions for the interrupt.

Here are the steps 1-2-3 to control the transmitter:

1. Reset the transmitter from the TX_RST_N pin
 2. Initialize the transmitter through the I2C interface
 3. Polling the interrupt pin INT_N continuously.
- If a HDMI sink device is detected (HDP flag is on):
 - Read and parse EDID to determine the capacity of the attached HDMI sink device.
 - Configure desired output video/audio, including color space and color depth.
 - Perform HDCP authentication
 - Output video/audio signals to the Video/Audio bus.
 - Stop video output if a video sink device is removed (HPD flag is off).
 - Perform proper actions according to various interrupt events.

2.4 Block Diagram of HDMI Signal Receiving

This section describes the block diagram of HDMI signal receiving.

Figure 2-4 shows the block diagram of HDMI signal receiving. Please refer to the schematic included in the CD for more details. The HDMI receiver is controlled through the I2C interface, where the host works as master and the transmitter works as a slave. Because the pin PCADR is pulled low, the transmitter I2C device address is set to 0x90. Through the I2C interface, the host board can access the internal registers of receiver to control its behavior. The receiver can support two receiving ports, but only one port can be activated at the same time.

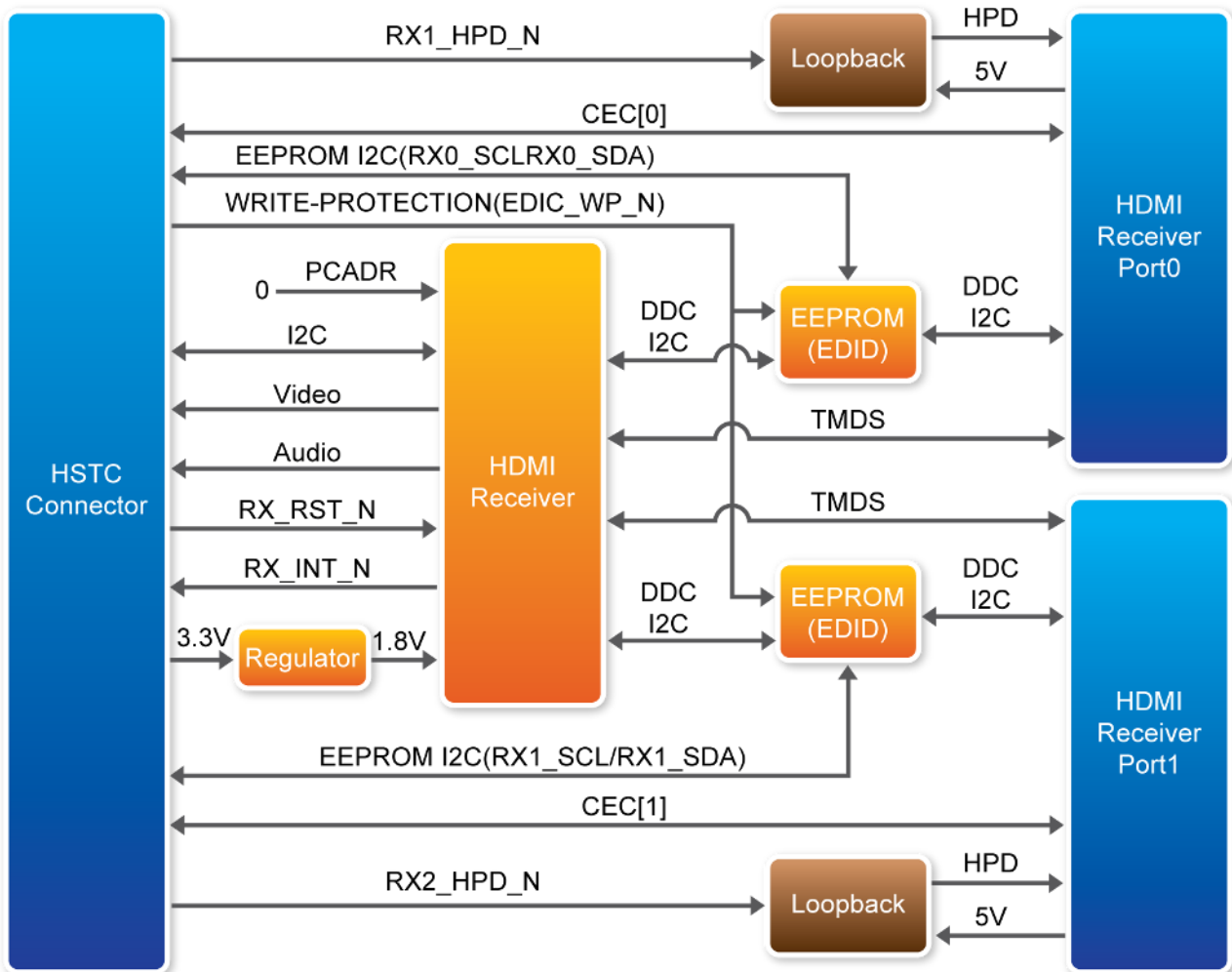

Figure 2-4 The block diagram of HDMI signal receiving

The host can use the reset pin RX_RST_N to reset the receiver, and listen to the interrupt pin RX_INT_N to detect change of the receiver status. When interrupt happens, the host needs to read the internal register to find out which event is triggered and perform proper actions for the interrupt.

Here are the steps to control the receiver:

1. Reset the receiver from the RX_RST_N pin
 2. Read the EEPROM (EDID) to check whether the EEPROM contents need to be updated. When writing data to EEPROM, remember to pull-low the EEPROM write protection pin EDID_WP. Finally, make sure EDID_WP is pulled high and configure the both I2C pins as input pins, so the attached HSTC source device can read the EDID successfully.
 3. Initialize the receiver through the I2C interface
 4. Pull-Low the RX1_HPDP_N and RX2_PHDP_N pins to enable HPD pins of receiving ports.
 5. Set receiver port 1 as active port.
 6. Polling the interrupt pin RX_INT_N. Switch to another receiver port every three seconds and activate it if no HDMI source device found on the current active port.
- If a HDMI source device is detected:
 - Perform HDCP authentication.
 - Read the input video format, including color space and color depth.
 - Configure input and output color space.
 - Perform proper actions according to various interrupt events.

2.5 Generate Pin Assignments

This section describes how to automatically generate a top-level project, including HDMI pin assignments.

Users can easily create the HDMI board pin assignments by utilizing the DE3_System Builder V 1.3.1 or later. Here are the procedures to generate a top-level project for THDB-HDMI.

1. Launch DE3-System Builder
2. Add a DE3 board. Enable the HSTC-C connector and type desired pin pre-fix name in the dialog of DE3 Configuration.

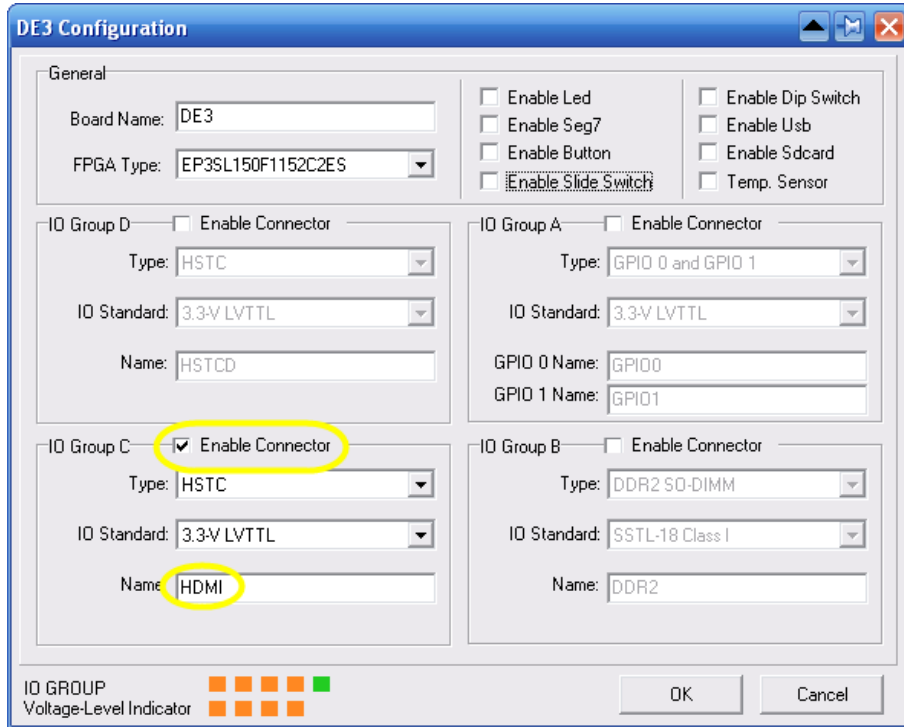

3. Add HDMI Board.

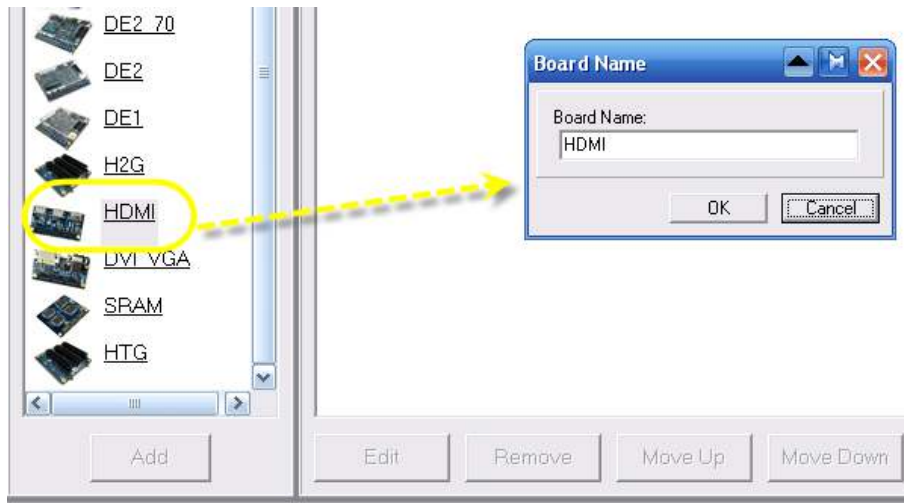

4. Connect DE3 and HDMI Board by drag-and-drop the mouse.

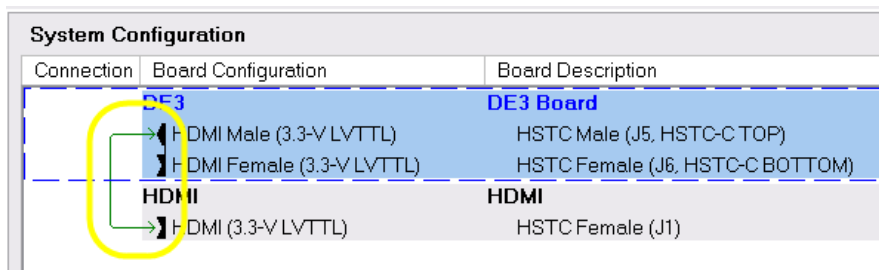

5. Click “Generate” to generate the desired top-level and pin assignments for a HDMI project.

2.6 Pin Definition of HSTC Connector

This section describes pin definition of the HSTC interface onboard.

All the control and data signals of HDMI transmitter and receiver are connected to the HSTC connector, so users can fully control the HDMI daughter board through the HSTC interface. Power is derived from 3.3V and 5V pins of the HSTC connector. **Figure 2-4** shows the physical pin location and signal name on the HSTC connector.

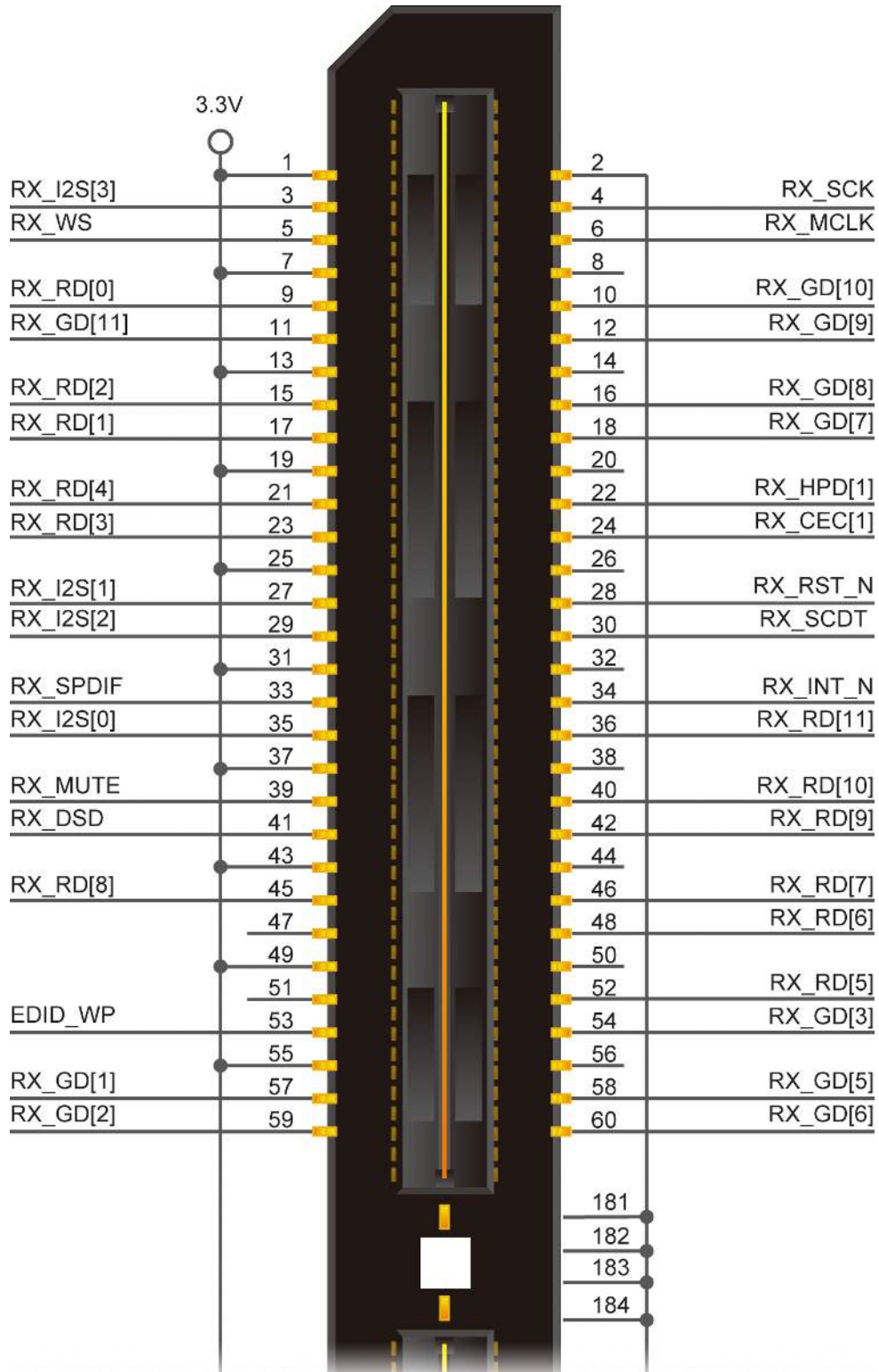

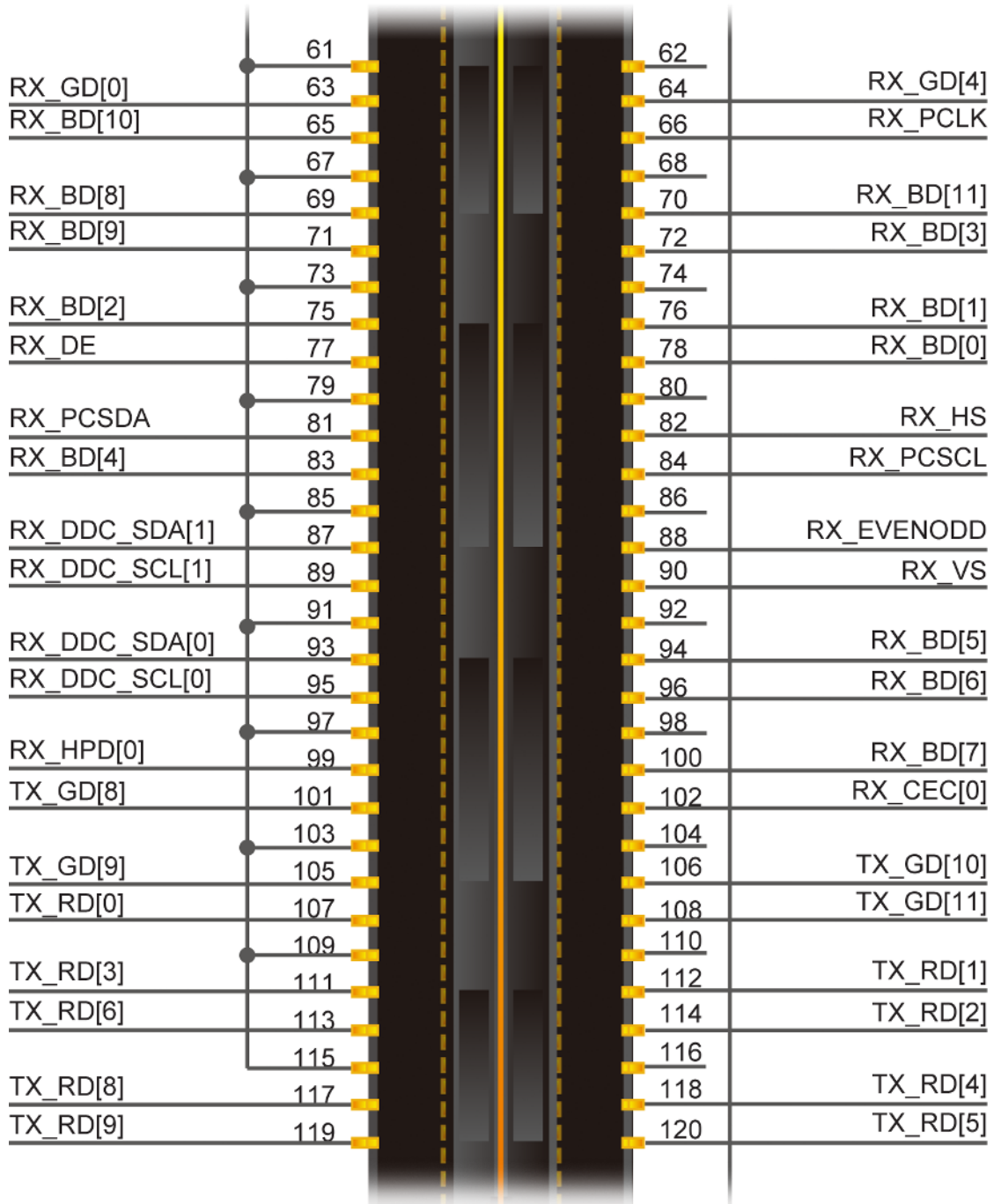

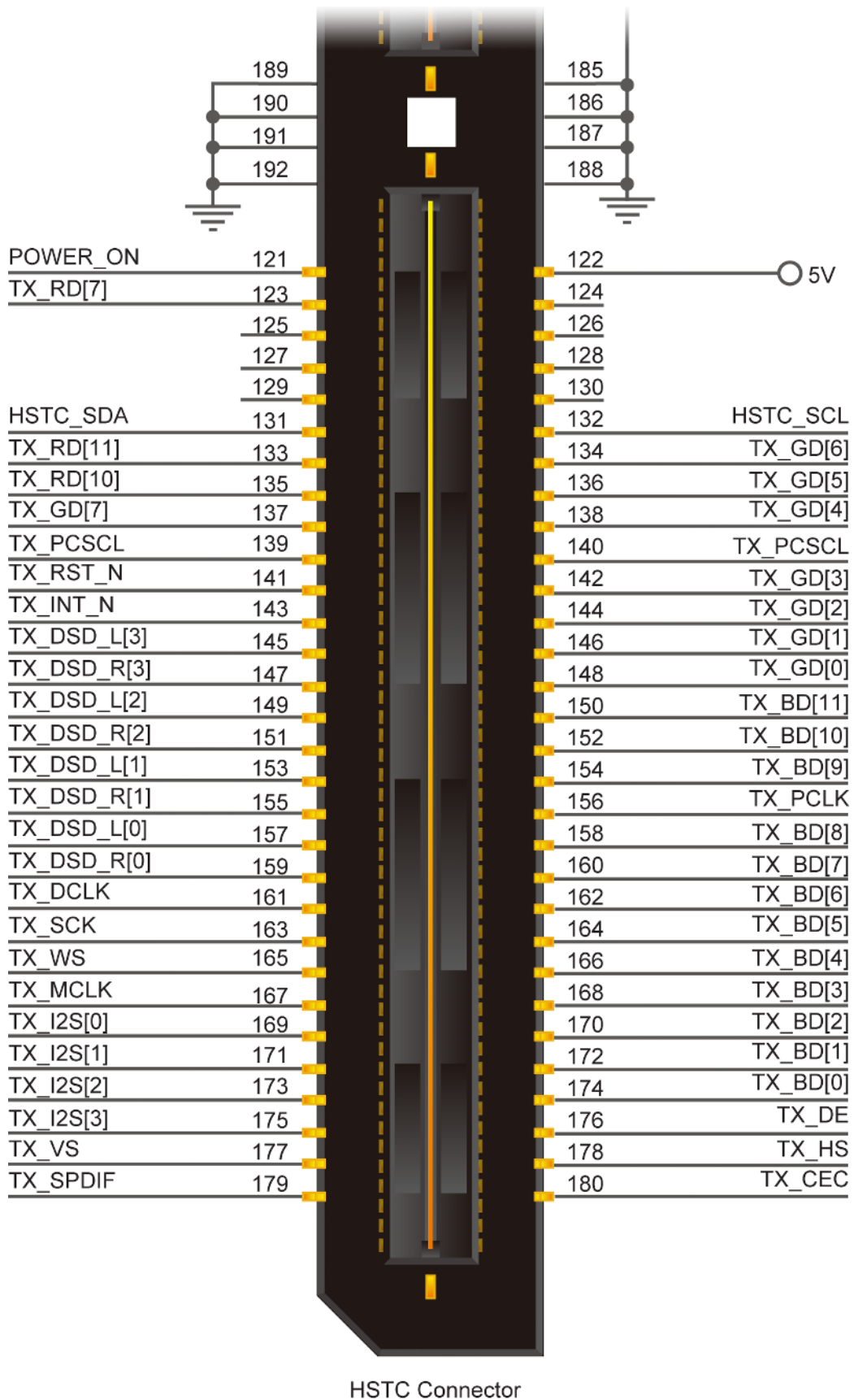

Figure 2-5 HSTC Connector of HDMI board

The table below lists the HSMC signal direction and description.

Note. The power pins are not shown in the table.

Table 2-3 The HSTC pin definition of the THDB-HDMI board

Signal Name	Pin Number	Direction (FPGA View)	Description
RX_I2S[3]	3	input	I2S serial data output, doubles as DSD Serial Right CH2 data output
RX_SCK	4	input	I2S serial clock output, doubles as DSD clock
RX_WS	5	input	I2S word select output, doubles as DSD Serial Right CH0 data output
RX_MCLK	6	input	Audio master clock
RX_RD[0]	9	input	Digital Video Output Pins.
RX_GD[10]	10	input	Digital Video Output Pins.
RX_GD[11]	11	input	Digital Video Output Pins.
RX_GD[9]	12	input	Digital Video Output Pins.
RX_RD[2]	15	input	Digital Video Output Pins.
RX_GD[8]	16	input	Digital Video Output Pins.
RX_RD[1]	17	input	Digital Video Output Pins.
RX_GD[7]	18	input	Digital Video Output Pins.
RX_RD[4]	21	input	Digital Video Output Pins.
RX_HPD[1]	22	output	Enable Hardware Plug Detection for HDMP Port 1, Low Active
RX_RD[3]	23	input	Digital Video Output Pins.
RX_CEC[1]	24	inout	CEC (Consumer Electronics Control) for HDMI Port 1
RX_I2S[1]	27	input	I2S serial data output, doubles as DSD Serial Right CH1 data output
RX_RST_N	28	input	Hardware reset pin. Active LOW
RX_I2S[2]	29	input	I2S serial data output, doubles as DSD Serial Left CH2 data output
RX_SCDT	30	input	Indication for active HDMI signal at input port
RX_SPDIF	33	input	S/PDIF audio output, doubles as DSD Serial Left CH2 data output
RX_INT_N	34	input	Interrupt output. Default active-low
RX_I2S[0]	35	input	I2S serial data output, doubles as DSD Serial Left CH0 data output
RX_RD[11]	36	input	Digital Video Output Pins.

RX_MUTE	39	input	Mute output, doubles as DSD Serial Right CH3 data output
RX_RD[10]	40	input	Digital Video Output Pins.
RX_DSD	41	input	DSD Serial Left CH3 data output
RX_RD[9]	42	input	Digital Video Output Pins.
RX_RD[8]	45	input	Digital Video Output Pins.
RX_RD[7]	46	input	Digital Video Output Pins.
RX_RD[6]	48	input	Digital Video Output Pins.
RX_RD[5]	52	input	Digital Video Output Pins.
EDID_WP	53	output	EEPROM Write Protection
RX_GD[3]	54	input	Digital Video Output Pins.
RX_GD[1]	57	input	Digital Video Output Pins.
RX_GD[5]	58	input	Digital Video Output Pins.
RX_GD[2]	59	input	Digital Video Output Pins.
RX_GD[6]	60	input	Digital Video Output Pins.
RX_GD[0]	63	input	Digital Video Output Pins.
RX_GD[4]	64	input	Digital Video Output Pins.
RX_BD[10]	65	input	Digital Video Output Pins.
RX_PCLK	66	input	Output data clock.
RX_BD[8]	69	input	Digital Video Output Pins.
RX_BD[11]	70	input	Digital Video Output Pins.
RX_BD[9]	71	input	Digital Video Output Pins.
RX_BD[3]	72	input	Digital Video Output Pins.
RX_BD[2]	75	input	Digital Video Output Pins.
RX_BD[1]	76	input	Digital Video Output Pins.
RX_DE	77	input	Data enable
RX_BD[0]	78	input	Digital Video Output Pins.
RX_PCSDA	81	inout	Serial Programming Data for chip programming
RX_HS	82	output	Horizontal sync. signal
RX_BD[4]	83	input	Digital Video Output Pins.
RX_PCSCSCL	84	inout	Serial Programming Clock for chip programming
RX_DDC_SDA[1]	87	inout	DDC I2C Data for HDMI Port 1
RX_EVENODD	88	input	Indicates whether the current field is Even or Odd for interlaced format
RX_DDC_SCL[1]	89	inout	DDC I2C Clock for HDMI Port 1
RX_VS	90	output	Vertical sync. signal
RX_DDC_SDA[0]	93	Inout	DDC I2C Data for HDMI Port 0
RX_BD[5]	94	Input	Digital Video Output Pins.
RX_DDC_SCL[0]	95	Inout	DDC I2C Clock for HDMI Port 0
RX_BD[6]	96	input	Digital Video Output Pins.
RX_HPD[0]	99	output	Enable Hardware Plug Detection for HDMP Port 0, Low Active
RX_BD[7]	100	Input	Digital Video Output Pins.
TX_GD[8]	101	output	Digital video input pins.
RX_CEC[0]	102	inout	CEC (Consumer Electronics Control) for

			HDMI Port 0
TX_GD[9]	105	output	Digital video input pins.
TX_GD[10]	106	output	Digital video input pins.
TX_RD[0]	107	output	Digital video input pins.
TX_GD[11]	108	output	Digital video input pins.
TX_RD[3]	111	output	Digital video input pins.
TX_RD[1]	112	output	Digital video input pins.
TX_RD[6]	113	output	Digital video input pins.
TX_RD[2]	114	output	Digital video input pins.
TX_RD[8]	117	output	Digital video input pins.
TX_RD[4]	118	output	Digital video input pins.
TX_RD[9]	119	output	Digital video input pins.
TX_RD[5]	120	output	Digital video input pins.
TX_RD[7]	123	output	Digital video input pins.
SDA	131	inout	I2S serial data for on-board EEPROM
SCL	132	output	I2S serial clock for on-board EEPROM
TX_RD[11]	133	output	Digital video input pins.
TX_GD[6]	134	output	Digital video input pins.
TX_RD[10]	135	output	Digital video input pins.
TX_GD[5]	136	output	Digital video input pins.
TX_GD[7]	137	output	Digital video input pins.
TX_GD[4]	138	output	Digital video input pins.
TX_PCSC	139	output	I ² C Clock for DDC
TX_PCSDA	140	inout	I ² C Data for DDC
TX_RST_N	141	output	Hardware reset pin. Active LOW
TX_GD[3]	142	output	Digital video input pins.
TX_INT_N	143	input	Interrupt output. Default active-low
TX_GD[2]	144	output	Digital video input pins.
TX_DSD_L[3]	145	output	DSD Serial Left CH3 data input
TX_GD[1]	146	output	Digital video input pins.
TX_DSD_R[3]	147	output	DSD Serial Right CH3 data input
TX_GD[0]	148	output	Digital video input pins.
TX_DSD_L[2]	149	output	DSD Serial Left CH2 data input
TX_BD[11]	150	output	Digital video input pins.
TX_DSD_R[2]	151	output	DSD Serial Right CH2 data input
TX_BD[10]	152	output	Digital video input pins.
TX_DSD_L[1]	153	output	DSD Serial Left CH1 data input
TX_BD[9]	154	output	Digital video input pins.
TX_DSD_R[1]	155	output	DSD Serial Right CH1 data input
TX_PCLK	156	output	Input data clock
TX_DSD_L[0]	157	output	DSD Serial Left CH0 data input
TX_BD[8]	158	output	Digital video input pins.
TX_DSD_R[0]	159	output	Digital video input pins.
TX_BD[7]	160	output	Digital video input pins.
TX_DCLK	161	output	DSD Serial audio clock input
TX_BD[6]	162	output	Digital video input pins.
TX_SCK	163	output	I2S serial clock input

TX_BD[5]	164	output	Digital video input pins.
TX_WS	165	output	I2S word select input
TX_BD[4]	166	output	Digital video input pins.
TX_MCLK	167	output	Audio master clock input
TX_BD[3]	168	output	Digital video input pins.
TX_I2S[0]	169	output	I2S serial data input
TX_BD[2]	170	output	Digital video input pins.
TX_I2S[1]	171	output	I2S serial data input
TX_BD[1]	172	output	Digital video input pins.
TX_I2S[2]	173	output	I2S serial data input
TX_BD[0]	174	output	Digital video input pins.
TX_I2S[3]	175	output	I2S serial data input
TX_DE	176	output	Data enable
TX_VS	177	output	Vertical sync. signal
TX_HS	178	output	Horizontal sync. signal
TX_SPDIF	179	output	S/PDIF audio input
TX_CEC	180	inout	CEC (Consumer Electronics Control)

Chapter 3

Demonstration

This chapter illustrates the video/audio demonstration for the HDMI board.

3.1 Introduction

This section describes the functionality of the demonstration briefly.

This demonstration shows how to use DE3 to control the HDMI board. The demonstration includes two parts:

■ **Transmission-Only:**

Generate HDMI Video/Audio signal for transmission, including various video formats and color space. There are 11 video formats available. The color space includes RGB444, YUV422, and YUV444.

■ **Loopback:**

Loopback (Internal bypass) the HDMI Video/Audio Signals. The audio and video output pins of the receiver are directly connected to the input audio and video pins of the transmitter.

3.2 System Requirements

The following items are required for transmission-only and loopback demonstrations.

■ **Transmission-Only**

- THDB-HDMI x 1
- DE3 Board x 1
- LCD monitor with at least one HDMI input x 1

- HDMI Cable x 1

■ Loopback

- THDB-HDMI x 1
- DE3 Board x 1
- LCD monitor with at least one HDMI input x 1
- HDMI Source Device x 1
- HDMI Cable x 2

3.3 Setup the Demonstration

Figure 3-1 and Figure 3-2 show how to setup hardware for transmission and loop-back demonstrations, respectively.

■ Transmission Only

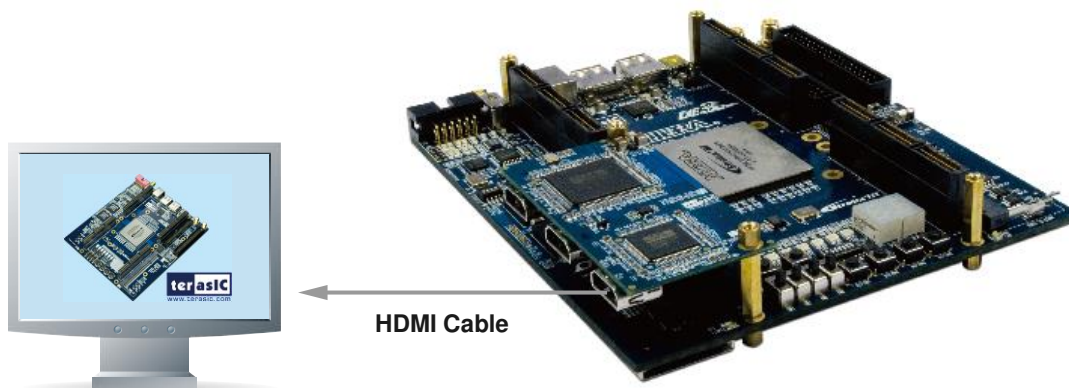

Figure 3-1 HDMI Transmission-Only Demonstration Setup

■ Loopback

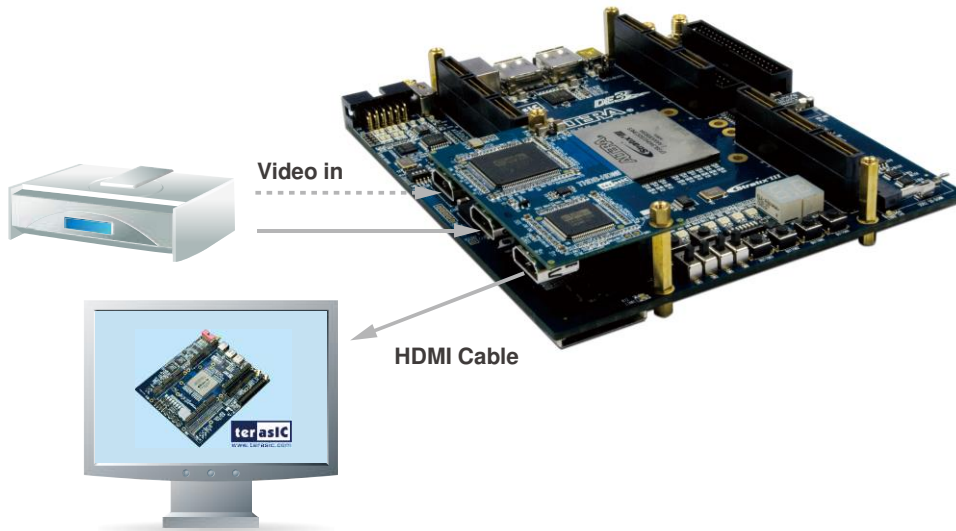

Figure 3-2 HDMI Loopback Demonstration Setup

3.4 Operation

This section describes the procedures of running the demonstration.

■ FPGA Configuration

Please follow the steps below to configure the FPGA.

- Make sure hardware setup is completed.
- Connect PC and DE3 with a USB cable.
- Power on DE3.
- Make sure Quartus II is installed on your PC.
- Execute the batch file `hdmi_demo.bat` under the folder “`examples\DE3_xxx_TX_RX\demo batch`”.

■ HDMI Transmission-Only

After FPGA is configured, please follow the steps below to run the HDMI transmission-only demonstration.

- Connect the HDMI LCD monitor and the HDMI transmitting port with a HDMI cable.
- Power on the LCD monitor and make sure the LCD monitor is set to the mode where HDMI input is the source. Please refer to the user manual of your HDMI Display for more details.

- When LCD monitor is detected, the LED2 of DE3 will be turned on.
- After approximately 10 seconds, a test pattern will be displayed on the LCD monitor. The first displayed pattern is 480p (720x480p60) pattern.
- Press “BUTTON0” to change test patterns. Please refer to **Table 4-2** for built-in test patterns. There are eleven built-in test patterns available in this demonstration. You will not be able to see all the test patterns if your LCD monitor doesn’t support such resolution.
- Press “BUTTON1” to change the color space of pattern source. The color space includes RGB444, YUV422, and YUV444.

Figure 3-3 and **Figure 3-4** show the test pattern of FULL HD (1920x1080p60) in RGB and YUV color space, respectively.

It will take approximately 10 seconds to display a new pattern on the LCD when users change test pattern or color space.



Figure 3-3 FULL HD in RGB444 Color Space

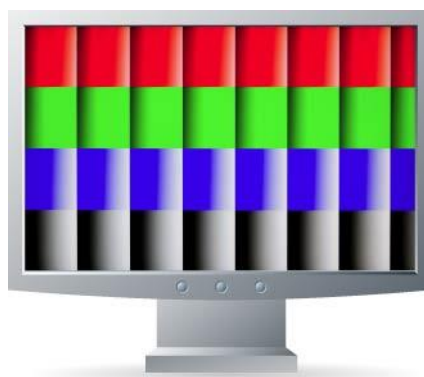

Figure 3-4 FULL HD in YUV Color Space

Figure 3-5 shows the NIOS program trace log when a HDMI LCD monitor is detected. It indicates the LCD monitor in use supports color space YUV444 and YUV422, but not RGB444. Various video formats supported are listed according to Video Identify Code (VIC). The format of input and

output color of the transmitter is RGB444 and RGB444, respectively. It implies there is no change of color format in between.

```
[TERASIC-00000.001]
===== HDMI Demo =====
[TERASIC-00000.002]TX hardware Reset
TX Chip Revision ID: 1
[TERASIC-00000.755][I2S]register callback success
[TERASIC-00000.756][I2S]register button callback success
[TERASIC-00000.758]RX hardware Reset
[TERASIC-00003.111]RX hardware Reset
[TERASIC-00004.541]RX Chip Revision ID: A1h
[TERASIC-00004.543]+++++++ RX HW Reset ++++++
[TERASIC-00004.546]RX hardware Reset
[TERASIC-00007.694][RX] Active Port: A
[TERASIC-00007.808]HPDChange
[TERASIC-00007.809]HPD=ON
[TERASIC-00010.577]Support Color: YUV444
[TERASIC-00010.578]Support Color: YUV422
[TERASIC-00010.581]HDMI Sink VIC(Video Identify Code)=3
[TERASIC-00010.583]HDMI Sink VIC(Video Identify Code)=18
[TERASIC-00010.585]HDMI Sink VIC(Video Identify Code)=4
[TERASIC-00010.588]HDMI Sink VIC(Video Identify Code)=19
[TERASIC-00010.590]HDMI Sink VIC(Video Identify Code)=5
[TERASIC-00010.592]HDMI Sink VIC(Video Identify Code)=20
[TERASIC-00010.595]HDMI Sink VIC(Video Identify Code)=16
[TERASIC-00010.597]HDMI Sink VIC(Video Identify Code)=31
[TERASIC-00010.599]HDMI Sink VIC(Video Identify Code)=9
[TERASIC-00010.601]HDMI Sink VIC(Video Identify Code)=1
[TERASIC-00010.604]HDMI Display found
[TERASIC-00010.605]HDMITX_SetOutput
[TERASIC-00010.653]===> Pattern Generator Mode: 0 (720x480p60 VIC=3)
[TERASIC-00010.702]Set Tx Color Depth: 24 bits
[TERASIC-00010.704]Set Tx Color Convert:RGB444->RGB444
[TERASIC-00011.441]ConfigAVIInfoFrame, VIC=3
```

Figure 3-5 NIOS program trace log of transmitting-only demonstration

■ HDMI Internal Loopback

After FPGA is configured, please follow the steps below to run the HDMI loopback demonstration.

- Connect the HDMI LCD and the HDMI TX port with a HDMI Cable.
- Power on the LCD monitor and make sure the LCD monitor is set to the mode where HDMI input is the source.
- Connect the HDMI source device and HDMI RX port with a HDMI Cable.
- Power on the HDMI source device and make sure its HDMI port is selected as the output.
- Users will be able to see the video displayed on the LCD monitor and hear the sound, if there is a speaker built-in.
- Users can change the RX port connected to the HDMI source device. The demonstration can automatically detect the RX port and activate it.

Figure 3-6 shows the NIOS program trace log when a HDMI LCD source device is detected. It indicates the input video resolution is 1280 x 720 (VIC=4) with color space RGB444 and 36-bits color depth.

Both input color and output color of the receiver and transmitter are configured as RGB444. In another words, the color format doesn't change from the source to the LCD monitor during the loopback process. The output color depth of the transmitter is configured as 24-bits.

```
[TERASIC-00016.656]+++++++ RX HW Reset ++++++
[TERASIC-00016.658]RX hardware Reset
[TERASIC-00016.815]Revision of Receiver:A2h
[TERASIC-00016.907]InitCAT6023(): reg07 = 1C, ucCurrentHDMIPort = 1
[TERASIC-00019.882][RX]Active Port: B
[TERASIC-00022.950]+++++++ RX HW Reset ++++++
[TERASIC-00022.953]RX hardware Reset
[TERASIC-00023.109]Revision of Receiver:A2h
[TERASIC-00023.200]InitCAT6023(): reg07 = 0C, ucCurrentHDMIPort = 0
[TERASIC-00026.175][RX]Active Port: A
[TERASIC-00027.256]CDR_RESET, reg10 = 01
[TERASIC-00027.521][RX] VState = 1, VSTATE_SyncWait
[TERASIC-00027.970]RXINT_VideoMode_Chg, -> VSTATE_SyncWait
[TERASIC-00028.059][RX] VState = 3, VSTATE_SyncChecking
[TERASIC-00028.334][RX] VState = 6, VSTATE_ModeDetecting
[TERASIC-00028.506]RXINT_VideoMode_Chg, -> VSTATE_SyncWait
[TERASIC-00028.558][RX] VState = 3, VSTATE_SyncChecking
[TERASIC-00028.620][RX] VState = 6, VSTATE_ModeDetecting
[TERASIC-00028.847]==== RX Video On ====
[TERASIC-00029.488][RX] VState = 7, VSTATE_VideoOn
[TERASIC-00029.490][RX] AState = 4, ASTATE_AudioOn
[TERASIC-00029.523]==== Input Display Res.: 1920 x 1080 @36bps =====
[TERASIC-00029.539]==== Input Audio: Rate=48000, Valid-Channel Mask=01h =====
[TERASIC-00029.551]H_Total = 2200
[TERASIC-00029.553]H_Display = 1920
[TERASIC-00029.563]H_FPorch = 88
[TERASIC-00029.573]H_Sync = 44
[TERASIC-00029.614]H_BPorch = 148
[TERASIC-00029.629]V_Total = 1125
[TERASIC-00029.631]V_Display = 1080
[TERASIC-00029.650]V_FPorch = 4
[TERASIC-00029.661]V_Sync = 44
[TERASIC-00029.707]V_BPorch = 5
[TERASIC-00029.713]V_SyncToDE = 41
[TERASIC-00029.776]VIC: 16 (1920x1080p@60)
[TERASIC-00029.778]Aspect Ratio = 16:9
[TERASIC-00029.779]ITU709 = No
[TERASIC-00029.781]Color Space = RGB444
[TERASIC-00029.782]=====
[TERASIC-00029.783][RX]Video On:Yes
[TERASIC-00029.990]HDMITX_SetOutput
[TERASIC-00030.717]ConfigAVIInfoFrame, VIC=16
[TERASIC-00033.109]Set Rx Color Convert:RGB444->RGB444
[TERASIC-00033.156]Set Tx Color Depth: 24 bits
[TERASIC-00033.158]Set Tx Color Convert:RGB444->RGB444
[TERASIC-00033.886]ConfigAVIInfoFrame, VIC=16
```

Figure 3-6 NIOS program trace log of loopback demonstration

Chapter 4

Case Study

This chapter describes the design concepts for the HDMI demonstration in the previous chapter.

4.1 Overview

This section describes the overview of the reference design.

This reference design shows how to use DE3 to control HDMI board. Please refer to the pervious chapter for the demonstration of this reference design.

The source code of the reference design can be found in the THDB-HDMI CD under the directory of Examples folder. The demonstration includes the following two major functions:

■ **Transmission only:**

Generate HDMI Video/Audio signals for transmission, including various video formats and color space. There are 11 video formats available. The color space includes RGB444, YUV422, and YUV444.

■ **Loopback:**

Loopback (internal bypass) the HDMI Video/Audio Signals. The audio and video output pins of the receiver are directly connected to the input audio and video pins of the transmitter.

4.2 System Function Block

This section will describe the system behavior in function blocks.

Figure 4-1 shows the system function block diagram of this demonstration. In the design, SOPC is included because NIOS II processor is used to control both transmitter and receiver through I2C interface.

The NIOS program is designed to run on the on-chip memory. A customized I2S controller is designed to generate I2S 48K stereo audio for the HDMI transmitting-only mode. The audio data is stored in the on-chip memory and sent to the HDMI transmitter by NIOS II processor.

The video pattern generator is designed to generate test patterns for HDMI transmitter-only mode. It provides eleven video formats in three color spaces. The source selector circuit is designed to select the desired video source between the video pattern generator and the video from the receiver. Four LEDs and two BUTTONs on DE3 are used for human interface. BUTTONs are designed to change the test pattern and associated color space for transmission. LEDs are designed to indicate the HDMI status, which is illustrated in [Table 4-1](#). BUTTONs are designed to change the video format and color space of the build-in video pattern generator, which is illustrated in [Table 4-2](#).

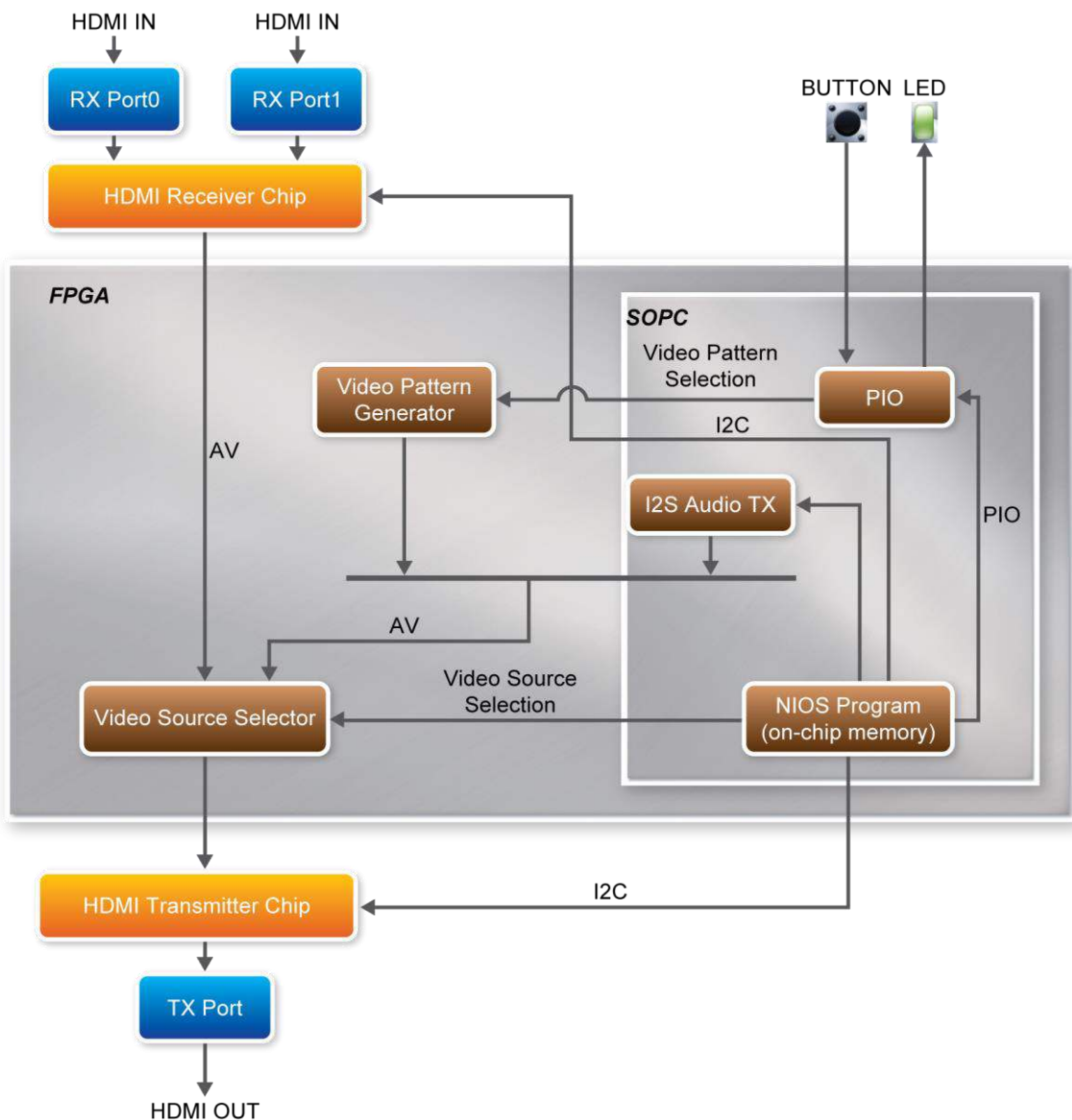

Figure 4-1 System Function Block Diagram

Table 4-1 LED Indications





LED	Description
 <p>LED1 LED0 LED1 LED0</p>	System is running.
 <p>LED2</p>	HDMI sink device is detected and synchronized.
 <p>LED3</p>	HDMI source device is detected and synchronized.

Table 4-2 Button Operation Definition

BUTTON	Description
 <p>BUTTON0</p>	Press to change active video format of the built-in video pattern generator.
 <p>BUTTON1</p>	Press to change active video color space of the built-in video pattern generator.

■ **Transmitter Controlled by NIOS II Processor**

The transmitter is controlled by NIOS program through I2C interface. Based on I2C protocol, the NIOS program can read/write the internal registers of the transmitter, and control the behavior of the transmitter. The NIOS program controls the transmitter to perform the following procedures step by step:

- Initialize the HDMI chip.
- Detect if a HDMI sink device is attached or detached, e.g. LCD Display.
- Read and parse the EDID content to find the capability of the HDMI sink device. The capability includes supported color space, video format (VIC code), and color depth etc.
- Perform HDCP authentication.
- Configure the color space of input and output. The transmitter offers color space transformation and outputs RGB444, YUV422, or YUV444
- Configure the color depth of output video.
- Send VIC to the video sink device.
- Configure the audio interface and format of output video.

■ Receiver Controlled by NIOS II Processor

The receiver is controlled by NIOS program through I2C interface. Based on I2C protocol, the NIOS program can read/ write the internal registers of the receiver, and control the behavior of the receiver. The revision number of receiver is either A1 or A2, which can be determined by querying the register 4 of receiver.

The major differences between both revisions are:

1. Receiver initialization process
2. Video synchronization process.

Please search the global variable “Is_A2” in it6605.c for detail information.

The NIOS program controls the receiver to perform the following procedures step by step:

- Initialize the HDMI receiver chip.
- Detect if a HDMI source device is attached or detached.
- Select one of the receiving ports and activate it.
- Read and parse the EDID content to find the capability of the HDMI source device. The capability includes supported color space, video format (VIC code), and color depth etc.
- Perform HDCP authentication.
- Report the input video (VIC) and audio format of the attached HDMI source device.
- Configure the color space of input and output. The receiver can provide color space transformation.

■ Video Pattern Generator

The video pattern generator is designed to generate test pattern for HDMI transmitting-only mode. The supported video formats are listed in [Table 4-2](#).

<i>Video Format</i>	<i>VIC</i>	<i>PCLK (MHZ)</i>
720x480p60	3	27
1024x76pP60	-	65
1280x720p50	19	74.25
1280x720p60	4	74.25
1280x1024	-	108
1920x1080i60	5	74.25
1920x1080i50	20	74.25
1920x1080p60	16	148.5
1920x1080p50	31	148.5

1600x1200p5	-	162
1920x1080i120	46	148.5

It also supports three color spaces, which are RGB444, YUV422, and YUV444.

The required PCLK is generated from Megafunction ALTPLL and ALTPLL_RECONFIG IP. The required PLL-reconfigure data is stored in on-chip ROMs.

■ Video Source Selector

The source selector is implemented using Megafunction LPM_MUX.

4.3 NIOS Program

This section describes the design flow and how Nios II processor controls transmitter and receiver.

Figure 4-2 shows the software stack of the NIOS program. The I2C block implements the I2C read/write functions based on GPIO system call. The HDMI transmitter block and receiver block are referred as the HDMI driver. The HDMI transmitter chip and receiver chip are managed and controlled through the I2C protocol. The I2S driver block is in charge of sending audio data to the transmitter.

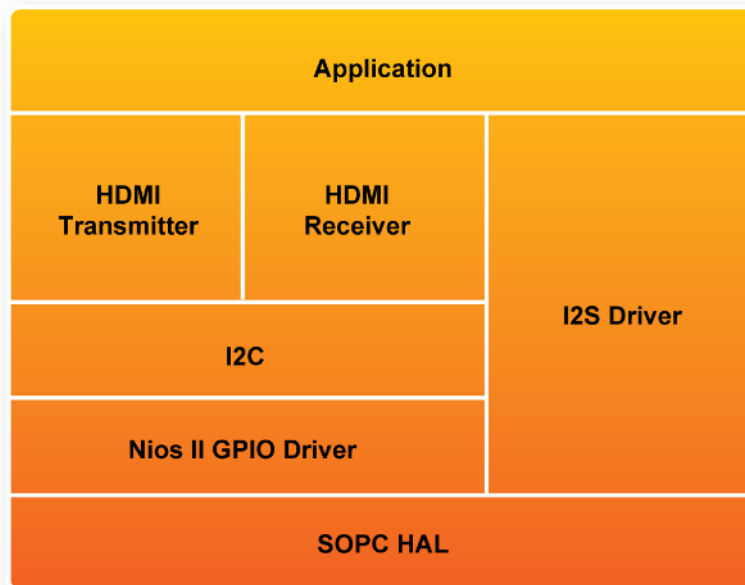

Figure 4-2 Software Stack

Figure 4-3 shows the file list of the NIOS program. The control center is located in main.c. The

beep.c includes audio raw data for generating a tone sound. The folder named terasic_lib includes the I2C driver. The folder named HDMI_Lib includes transmitter and receiver drivers. The platform-dependent functions are located in mcu.c under HDMI_Lib.

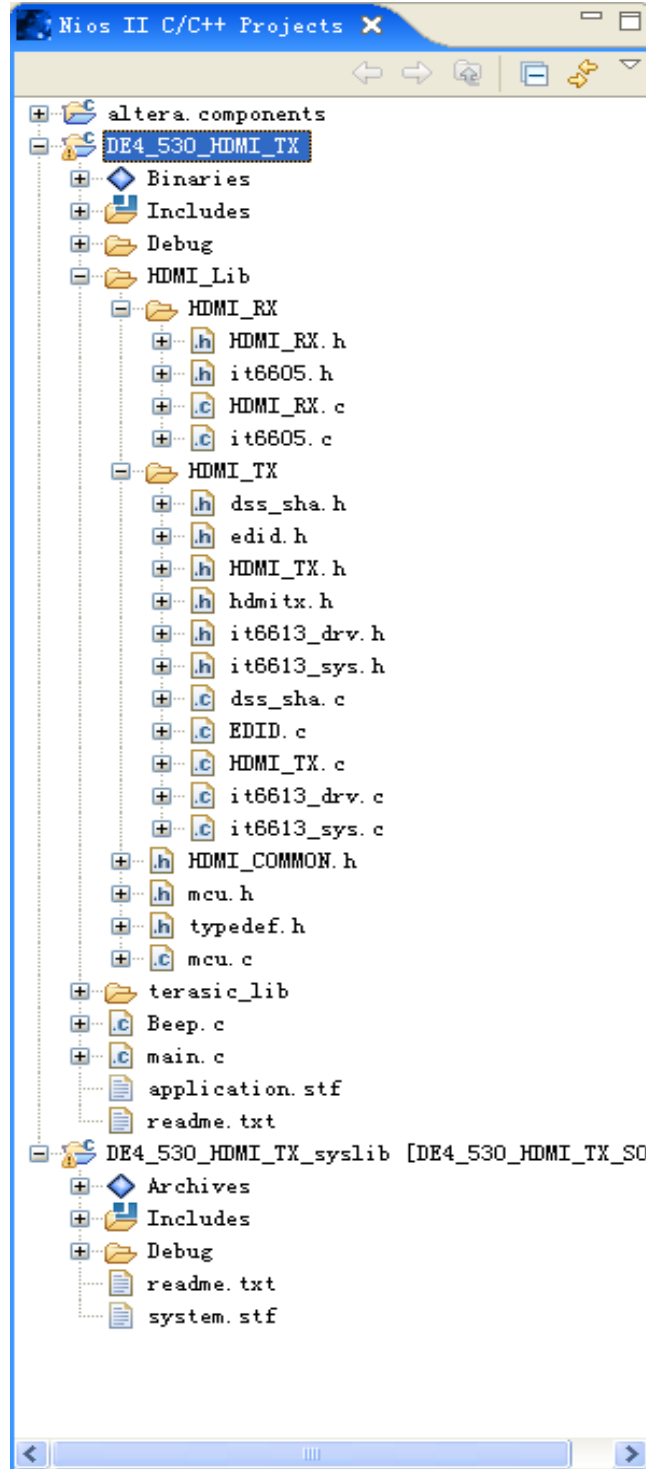

Figure 4-3 NIOS Program File List

■ System Configuration

To use the HDMI library in NIOS II, the const `_MCU_` should be defined in the configuration settings, as shown in **Figure 4-4**. Two on-chip memories are created to store the NIOS program and data separately. The size of each on-chip memory is 128 K bytes. One on-chip memory is used to store program and the other one is used to store data. The option “Small C Library” must be enabled to reduce the size of the program. The associated configuration is shown in **Figure 4-5**

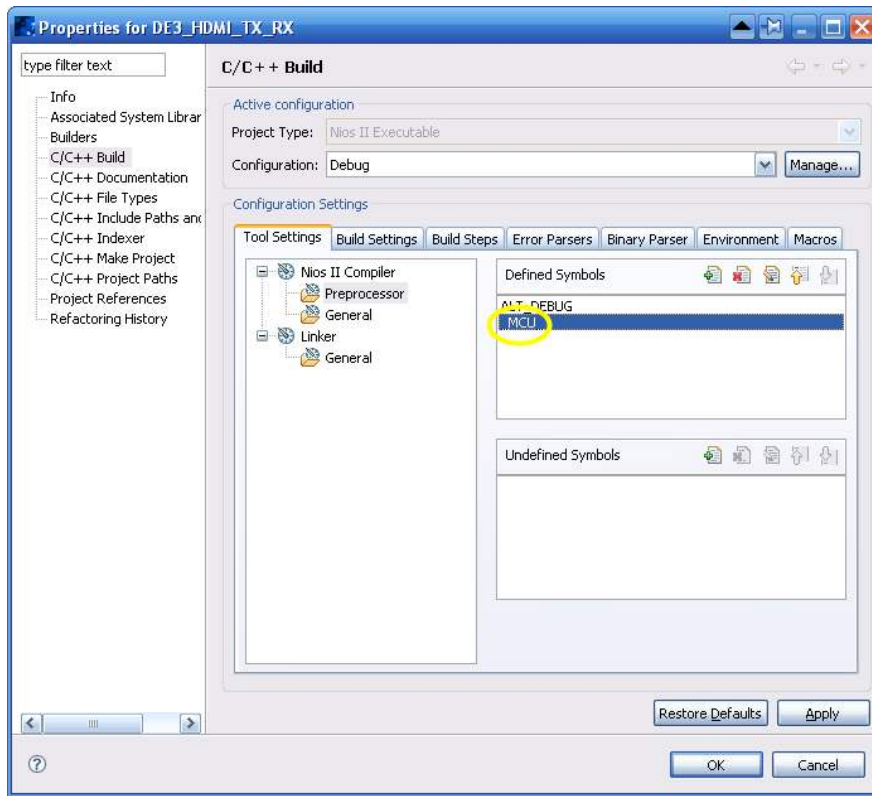

Figure 4-4 Define `_MCU_` constant

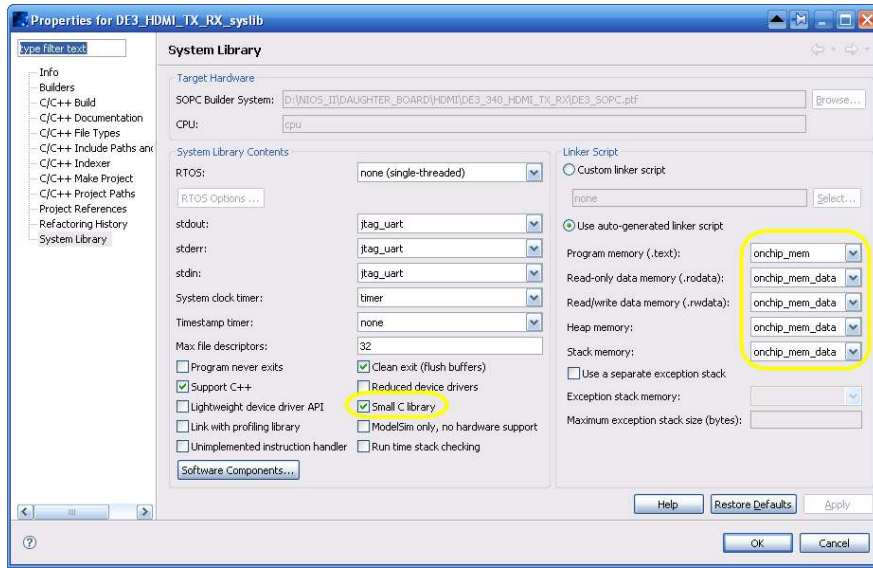

Figure 4-5 Configuration of System Library

■ Audio Test

If users would like to test audio during HDMI transmitting-only mode, please remove the constant definition `TX_VPG_COLOR_CTRL_DISABLED` from `main.c`. Users will hear a tone sound from the built-in speaker of HDMI LCD monitor when pressing `BUTTON1` of DE3 board.

5.1 Revision History

<i>Revision</i>	<i>Date</i>	<i>Change Log</i>
1.0	DEC 02 2008	Initial Version
1.1	APR 06 2009	Support Receiver Revision A2
1.2	JAN 04 2010	Figure 2-1 Corrected
1.3	MAR 09 2011	Support HDMI 1.4
1.4	AUG 01 2017	Contact Information

5.2 Always Visit THDB-HDMI Webpage for Update

We will be continuing providing interesting examples and labs on our THDB-HDMI web page. Please visit www.altera.com or hdmi.terasic.com for more information.