

70MHz, High Slew Rate, High Output Current Operational Amplifier

November 1996

Features

- Stable at Gains of 2 or Greater
- Gain Bandwidth 70MHz
- High Slew Rate 300V/μs (Min)
- High Output Current 100mA (Min)
- Power Bandwidth 5.5MHz (Typ)
- Output Voltage Swing ±10V (Min)
- Monolithic Bipolar Dielectric Isolation Construction

Applications

- Pulse and Video Amplifiers
- Wideband Amplifiers
- Coaxial Cable Drivers
- Fast Sample-Hold Circuits
- High Frequency Signal Conditioning Circuits

Ordering Information

PART NUMBER	TEMP. RANGE (°C)	PACKAGE	PKG. NO.
HA1-2542-2	-55 to 125	14 Ld CERDIP	F14.3
HA1-2542-5	0 to 75	14 Ld CERDIP	F14.3
HA2-2542-2	-55 to 125	12 Pin Metal Can	T12.C
HA2-2542-5	0 to 75	12 Pin Metal Can	T12.C
HA3-2542-5	0 to 75	14 Ld PDIP	E14.3

Description

The HA-2542 is a wideband, high slew rate, monolithic operational amplifier featuring an outstanding combination of speed, bandwidth, and output drive capability.

Utilizing the advantages of the Harris D.I. technology this amplifier offers 350V/μs slew rate, 70MHz gain bandwidth, and ±100mA output current. Application of this device is further enhanced through stable operation down to closed loop gains of 2.

For additional flexibility, offset null and frequency compensation controls are included in the HA-2542 pinout.

The capabilities of the HA-2542 are ideally suited for high speed coaxial cable driver circuits where low gain and high output drive requirements are necessary. With 5.5MHz full power bandwidth, this amplifier is most suitable for high frequency signal conditioning circuits and pulse video amplifiers. Other applications utilizing the HA-2542 advantages include wideband amplifiers and fast sample-hold circuits.

For more information on the HA-2542, please refer to Application Note AN552 (Using the HA-2542), or Application Note AN556 (Thermal Safe-Operating-Areas for High Current Op Amps).

For a lower power version of this product, please see the HA-2842 data sheet.

Pinouts

HA-2542
(PDIP, CERDIP)
TOP VIEW

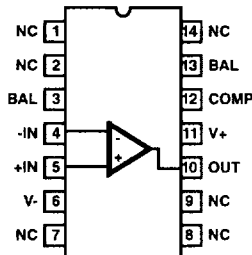

HA-2542
(METAL CAN)
TOP VIEW

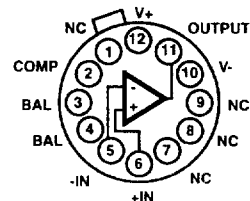

HA-2542

Absolute Maximum Ratings

Supply Voltage (Between V+ and V- Terminals)	35V
Differential Input Voltage	6V
Output Current	50mA Continuous, 125mAPEAK

Thermal Information

Thermal Resistance (Typical, Note 2)	θ_{JA} (°C/W)	θ_{JC} (°C/W)
CERDIP Package	75	20
PDIP Package	100	N/A
Metal Can Package	65	34
Maximum Junction Temperature (Note 1, Hermetic Packages)	175°C	
Maximum Junction Temperature (Plastic Package)	150°C	
Maximum Storage Temperature Range	-65°C to 150°C	
Maximum Lead Temperature (Soldering 10s)	300°C	

Operating Conditions

Temperature Range	
HA-2542-2	-55°C to 125°C
HA-2542-5	0°C to 75°C

CAUTION: Stresses above those listed in "Absolute Maximum Ratings" may cause permanent damage to the device. This is a stress only rating and operation of the device at these or any other conditions above those indicated in the operational sections of this specification is not implied.

NOTES:

- Maximum power dissipation with load conditions must be designed to maintain the maximum junction temperature below 175°C for ceramic and can packages, and below 150°C for plastic packages. By using Application Note AN556 on Safe Operating Area equations along with the thermal resistances, proper load conditions can be determined. Heatsinking will be required in many applications. See the "Application Information" section to determine if heat sinking is required for your application.
- θ_{JA} is measured with the component mounted on an evaluation PC board in free air.

Electrical Specifications $V_{SUPPLY} = \pm 15V$, $R_L = 1k\Omega$, $C_L \leq 10pF$, Unless Otherwise Specified

PARAMETER	TEST CONDITIONS	TEMP. (°C)	HA-2542-2 -55°C to 125°C			HA-2542-5 0°C to 75°C			UNITS
			MIN	TYP	MAX	MIN	TYP	MAX	
INPUT CHARACTERISTICS									
Offset Voltage		25	-	5	10	-	5	10	mV
		Full	-	8	20	-	8	20	mV
Average Offset Voltage Drift		Full	-	14	-	-	14	-	$\mu V/^\circ C$
Bias Current		25	-	15	35	-	15	35	μA
		Full	-	26	50	-	26	50	μA
Average Bias Current Drift		Full	-	66	-	-	45	-	$nA/^\circ C$
Offset Current		25	-	1	7	-	1	7	μA
		Full	-	-	9	-	-	9	μA
Input Resistance		25	-	100	-	-	100	-	$k\Omega$
Input Capacitance		25	-	1	-	-	1	-	pF
Common Mode Range		Full	± 10	-	-	± 10	-	-	V
Input Noise Voltage	0.1Hz to 100Hz	25	-	2.2	-	-	2.2	-	μV_{p-p}
Input Noise Density	$f = 1kHz$, $R_G = 0\Omega$	25	-	10	-	-	10	-	nV/\sqrt{Hz}
Input Noise Current Density	$f = 1kHz$, $R_G = 0\Omega$	25	-	3	-	-	3	-	pA/\sqrt{Hz}
TRANSFER CHARACTERISTICS									
Large Signal Voltage Gain	$V_O = \pm 10V$	25	10	30	-	10	30	-	kV/V
		Full	5	15	-	5	20	-	kV/V
Common Mode Rejection Ratio	$V_{CM} = \pm 10V$	Full	70	100	-	70	100	-	dB
Minimum Stable Gain		25	2	-	-	2	-	-	V/V
Gain Bandwidth Product	$A_V = 100$	25	-	70	-	-	70	-	MHz
OUTPUT CHARACTERISTICS									
Output Voltage Swing		Full	± 10	± 11	-	± 10	± 11	-	V
Output Current (Note 3)		25	100	-	-	100	-	-	mA
Output Resistance		25	-	5	-	-	5	-	Ω

3

OPERATIONAL AMPLIFIERS

HA-2542

Electrical Specifications $V_{SUPPLY} = \pm 15V$, $R_L = 1k\Omega$, $C_L \leq 10pF$, Unless Otherwise Specified (Continued)

PARAMETER	TEST CONDITIONS	TEMP. (°C)	HA-2542-2 -55°C to 125°C			HA-2542-5 0°C to 75°C			UNITS
			MIN	TYP	MAX	MIN	TYP	MAX	
Full Power Bandwidth (Note 4)	$V_{PEAK} = 10V$	25	4.7	5.5	-	4.7	5.5	-	MHz
Differential Gain (Note 5)		25	-	0.1	-	-	0.1	-	%
Differential Phase (Note 5)		25	-	0.2	-	-	0.2	-	Degree
Harmonic Distortion (Note 7)		25	-	<0.04	-	-	<0.04	-	%
TRANSIENT RESPONSE (Note 6)									
Rise Time		25	-	4	-	-	4	-	ns
Overshoot		25	-	25	-	-	25	-	%
Slew Rate		25	300	350	-	300	350	-	V/ μ s
Settling Time	10V Step to 0.1%	25	-	100	-	-	100	-	ns
	10V Step to 0.01%	25	-	200	-	-	200	-	ns
POWER SUPPLY CHARACTERISTICS									
Supply Current		25	-	30	-	-	30	-	mA
		Full	-	31	34.5	-	31	40	mA
Power Supply Rejection Ratio	$V_S = \pm 5V$ to $\pm 15V$	Full	70	79	-	70	79	-	dB

NOTES:

- $R_L = 50\Omega$, $V_O = \pm 5V$. Output duty cycle must be reduced for $I_{OUT} > 50mA$ (e.g. $\leq 50\%$ duty cycle for 100mA).
- Full Power Bandwidth guaranteed based on slew rate measurement using: $FPBW = \frac{\text{Slew Rate}}{2\pi V_{PEAK}}$
- Differential gain and phase are measured at 5MHz with a 1V differential input voltage
- Refer to Test Circuits section of this data sheet.
- $V_{IN} = 1V_{RMS}$; $f = 10kHz$; $A_V = 10$.

Test Circuits and Waveforms

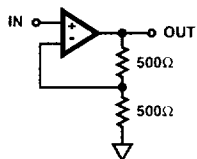

NOTES:

- $V_S = \pm 15V$.
- $A_V = +2$.
- $C_L \leq 10pF$.

TEST CIRCUIT

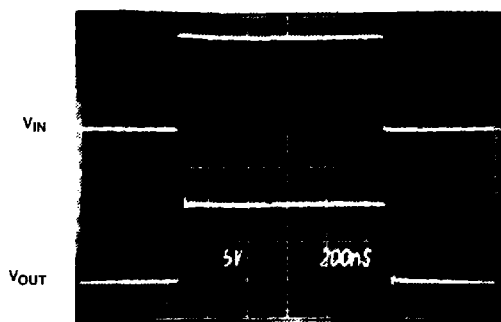

Vertical Scale: $V_{IN} = 2.0V/Div.$, $V_{OUT} = 5.0V/Div.$
Horizontal Scale: 200ns/Div.

LARGE SIGNAL RESPONSE

Test Circuits and Waveforms (Continued)

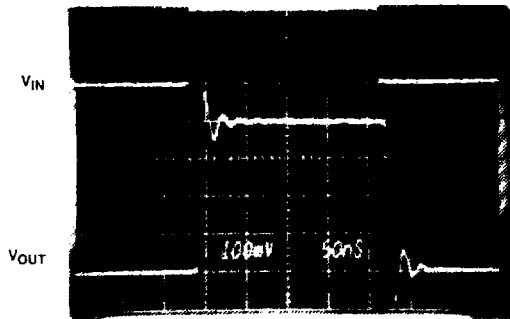

Vertical Scale: 100mV/Div.
Horizontal Scale: 50ns/Div.

SMALL SIGNAL RESPONSE

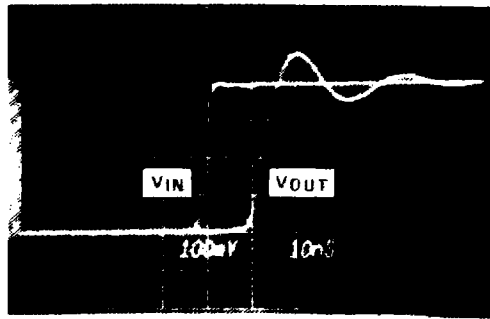

Vertical Scale: 100mV/Div.
Horizontal Scale: 10ns/Div.
 $V_S = \pm 15V$, $R_L = 1k\Omega$. Propagation delay variance is negligible over full temperature range.

PROPAGATION DELAY

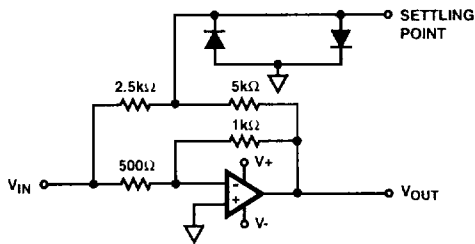

SETTLING TIME TEST CIRCUIT (See Notes 11 - 15.)

NOTES:

11. $A_V = -2$.
12. Feedback and summing resistors must be matched (0.1%).
13. HP5082-2810 clipping diodes recommended.
14. Tektronix P6201 FET probe used at settling point.
15. For 0.01% settling time, heat sinking is suggested to reduce thermal effects and an analog ground plane with supply decoupling is suggested to minimize ground loop errors.

Schematic Diagram

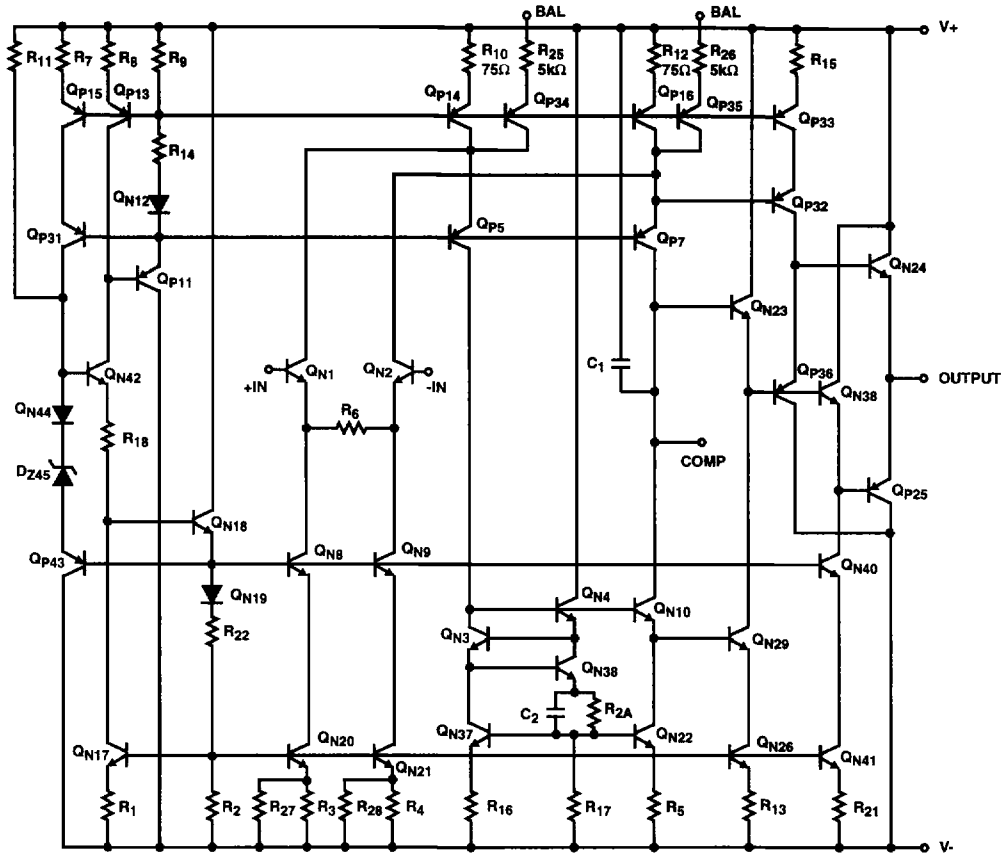
**Application Information** (Refer to Application Note AN552 for Further Information)

The Harris HA-2542 is a state of the art monolithic device which also approaches the "ALL-IN-ONE" amplifier concept. This device features an outstanding set of AC parameters augmented by excellent output drive capability providing for suitable application in both high speed and high output drive circuits.

Primarily intended to be used in balanced 50Ω and 75Ω coaxial cable systems as a driver, the HA-2542 could also be used as a power booster in audio systems as well as a power amp in power supply circuits. This device would also be suitable as a small DC motor driver.

The applications shown in Figures 2 through Figure 4 demonstrate the HA-2542 at gains of +100 and +2 and as a video cable driver for small signals.

Power Dissipation Considerations

At high output currents, especially with the PDIP package, care must be taken to ensure that the Maximum Junction Temperature (T_J , see "Absolute Maximum Ratings" table) is not exceeded. As an example consider the HA-2542 in the PDIP package, with a required output current of 20mA at $V_{OUT} = 5V$. The power dissipation is the quiescent power ($1.2W = 30V \times 40mA$) plus the power dissipated in the output stage ($P_{OUT} = 200mW = 20mA \times (15V - 5V)$), or a total of 1.4W. The thermal resistance (θ_{JA}) of the PDIP package is $100^\circ C/W$, which increases the junction temperature by $140^\circ C$ over the ambient temperature (T_A). Remaining below T_{JMAX} requires that T_A be restricted to $\leq 10^\circ C$ ($150^\circ C - 140^\circ C$). Heatsinking would be required for operation at ambient temperatures greater than $10^\circ C$.

Note that the problem isn't as severe with either the CERPDP or Can packages due to their lower thermal resistances, and higher T_{JMAX} . Nevertheless, it is recommended that Figure 1 be used to ensure that heat sinking is not required.

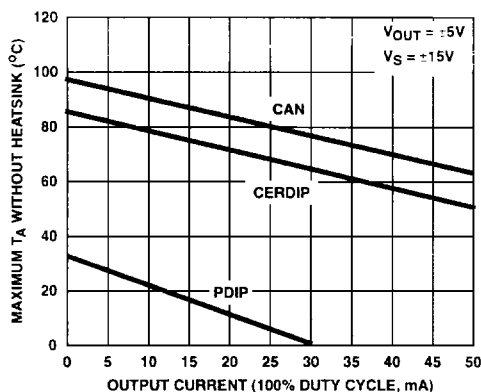

FIGURE 1. MAXIMUM OPERATING TEMPERATURE vs OUTPUT CURRENT

Allowable output power can be increased by decreasing the quiescent dissipation via lower supply voltages.

For more information please refer to Application Note AN556, "Thermal Safe Operating Areas for High Current Op Amps".

Prototyping Guidelines

For best overall performance in any application, it is recommended that high frequency layout techniques be used. This should include: 1) mounting the device through a ground plane; 2) connecting unused pins (NC) to the ground; 3) mounting feedback components on Teflon standoffs and or locating these components as close to the device as possible; 4) placing power supply decoupling capacitors from device supply pins to ground.

As a result of speed and bandwidth optimization, the HA-2542 can's case potential, when powered-up, is equal to the V- potential. Therefore, contact with other circuitry or ground should be avoided.

Frequency Compensation

The HA-2542 may be externally compensated with a single capacitor to ground. This provides the user the additional flexibility in tailoring the frequency response of the amplifier. A guideline to the response is demonstrated on the typical performance curve showing the normalized AC parameters versus compensation capacitance. It is suggested that the user check and tailor the accurate compensation value for each application. As shown additional phase margin is achieved at the loss of slew rate and bandwidth.

For example, for a voltage gain of +2 (or -1) and a load of 500pF/2kΩ 20pF is needed for compensation to give a small signal bandwidth of 30MHz with 40° of phase margin. If a full power output voltage of ±10V is needed, this same configuration will provide a bandwidth of 5MHz and a slew rate of 200V/μs.

If maximum bandwidth is desired and no compensation is needed, care must be given to minimize parasitic capacitance at the compensation pin. In some cases where minimum gain applications are desired, bending up or totally removing this pin may be the solution. In this case, care must also be given to minimize load capacitance.

For wideband positive unity gain applications, the HA-2542 can also be over-compensated with capacitance greater than 30pF to achieve bandwidths of around 25MHz. This over-compensation will also improve capacitive load handling or lower the noise bandwidth. This versatility along with the ±100mA output current makes the HA-2542 an excellent high speed driver for many power applications.

3
OPERATIONAL AMPLIFIERS

Typical Applications

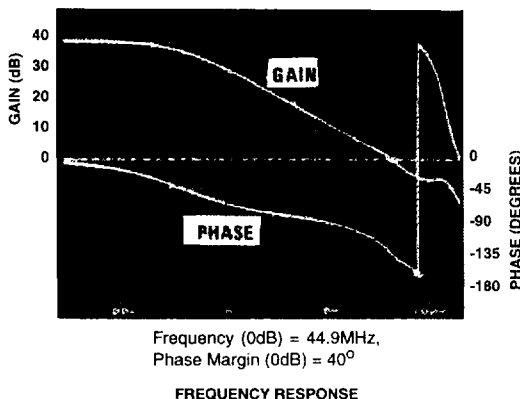
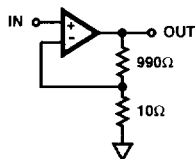
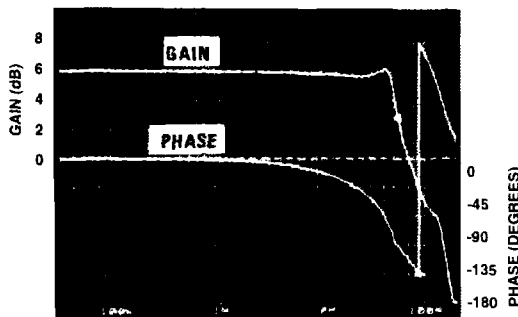
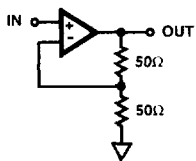

FIGURE 2. NONINVERTING CIRCUIT (AVCL = 100)

Typical Applications (Continued)



Frequency (dB) = 56MHz. Phase Margin (3dB) = 40°

FREQUENCY RESPONSE

FIGURE 3. NONINVERTING CIRCUIT ($A_{VCL} = 2$)

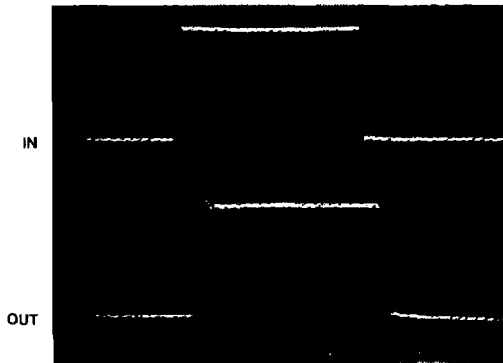
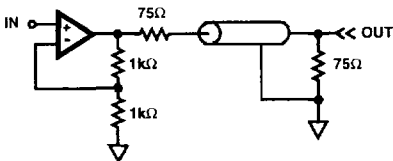

1V/Div.; 100ns/Div.

PULSE RESPONSE

FIGURE 4. VIDEO CABLE DRIVER ($A_{VCL} = 2$)

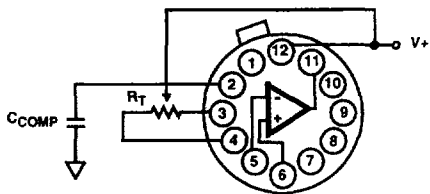

NOTES:

- 16. Suggested compensation scheme 5pF - 20pF.
- 17. Tested Offset Adjustment Range is $IV_{OS} + 1mV$ minimum referred to output.
- 18. Typical range is $\pm 20mV$ with $R_T = 5k\Omega$.

FIGURE 5. SUGGESTED OFFSET VOLTAGE ADJUSTMENT AND FREQUENCY COMPENSATION

Typical Performance Curves

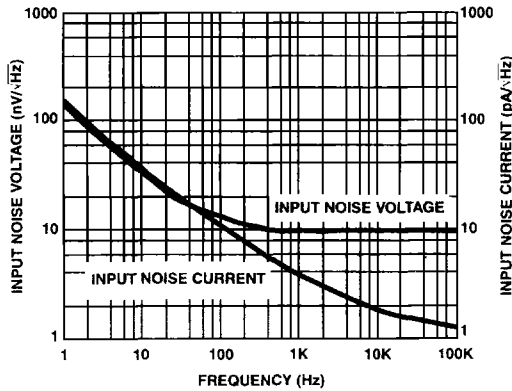

FIGURE 6. INPUT NOISE VOLTAGE AND INPUT NOISE CURRENT vs FREQUENCY

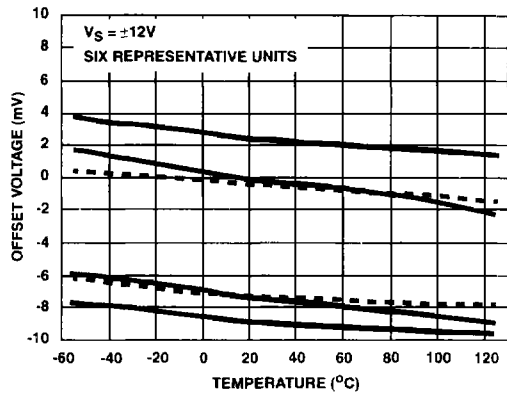

FIGURE 7. OFFSET VOLTAGE vs TEMPERATURE

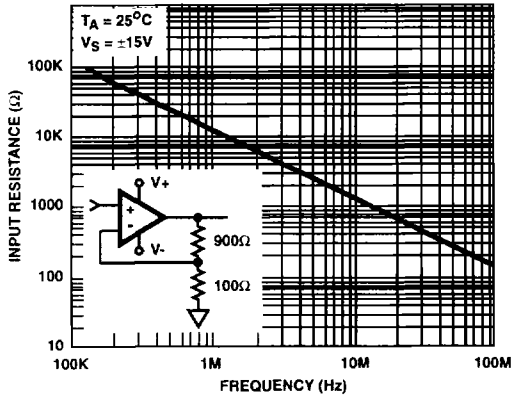

FIGURE 8. INPUT RESISTANCE vs FREQUENCY

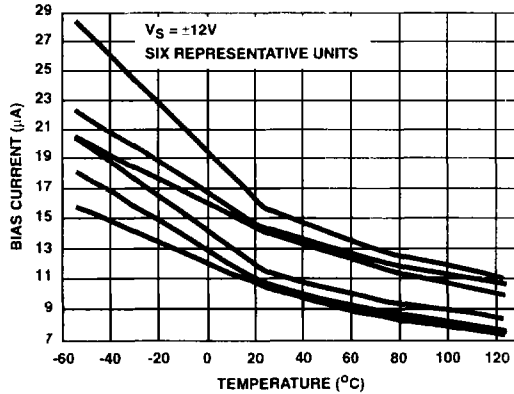

FIGURE 9. BIAS CURRENT vs TEMPERATURE

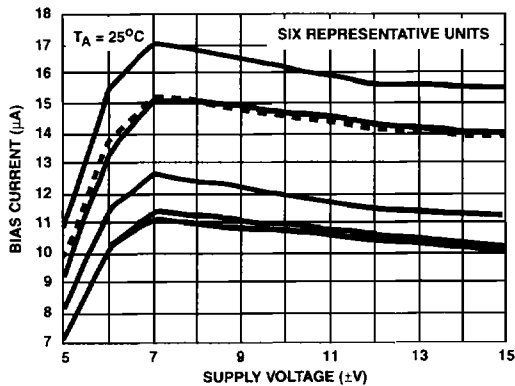

FIGURE 10. BIAS CURRENT vs SUPPLY VOLTAGE

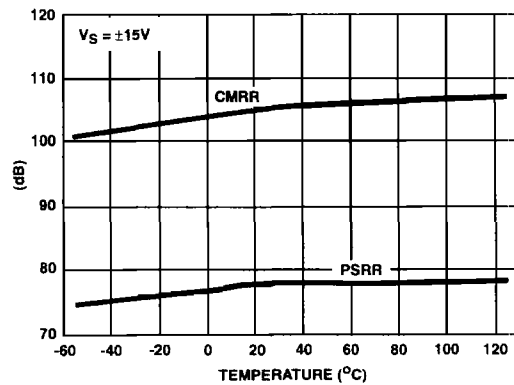

FIGURE 11. PSRR AND CMRR vs TEMPERATURE

Typical Performance Curves (Continued)

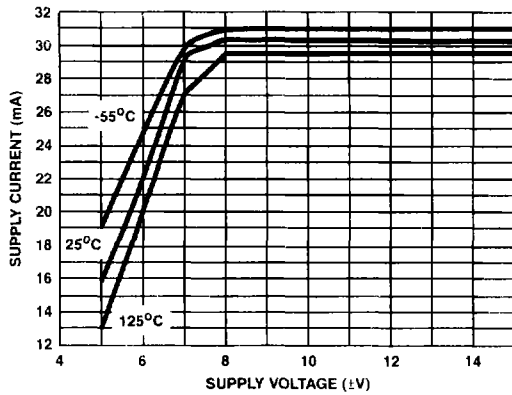

FIGURE 12. SUPPLY CURRENT vs SUPPLY VOLTAGE, AT VARIOUS TEMPERATURES

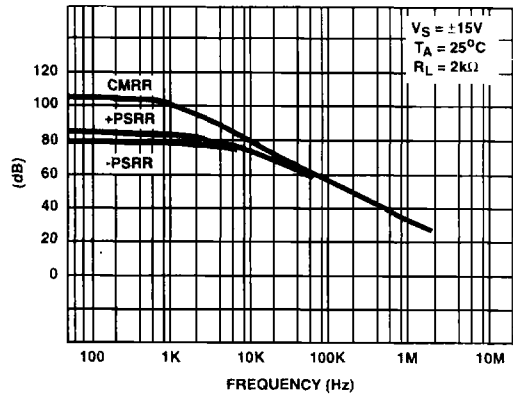

FIGURE 13. PSRR AND CMRR vs FREQUENCY

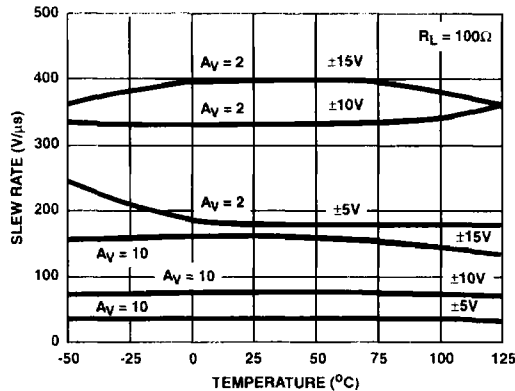

FIGURE 14. SLEW RATE vs TEMPERATURE AT VARIOUS SUPPLY VOLTAGES

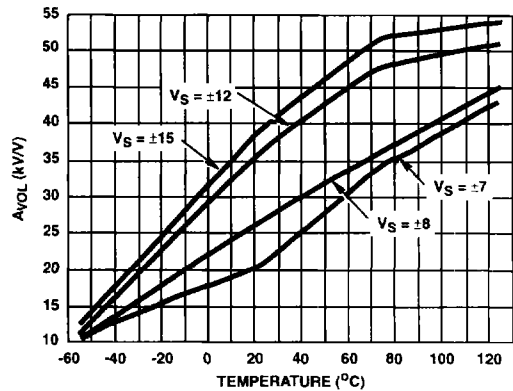

FIGURE 15. OPEN LOOP GAIN vs TEMPERATURE, AT VARIOUS SUPPLY VOLTAGES

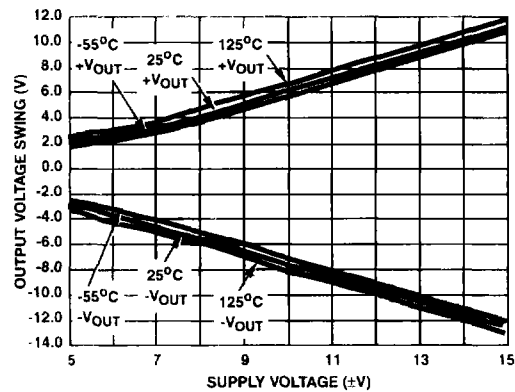

FIGURE 16. OUTPUT VOLTAGE SWING vs SUPPLY VOLTAGE, AT VARIOUS TEMPERATURES

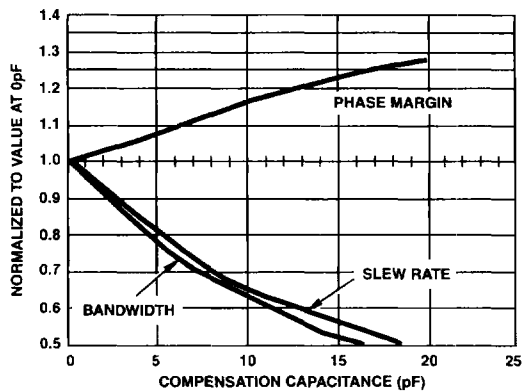

FIGURE 17. NORMALIZED AC PARAMETERS vs COMPENSATION CAPACITANCE

Typical Performance Curves (Continued)

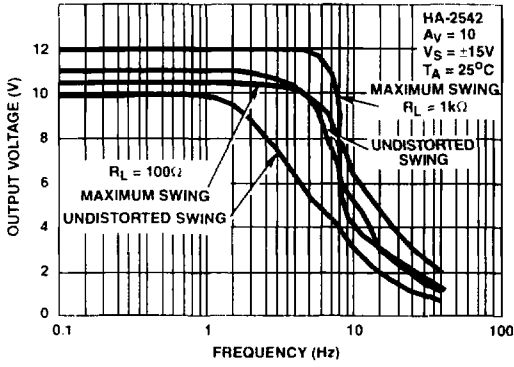

FIGURE 18. OUTPUT VOLTAGE SWING vs FREQUENCY

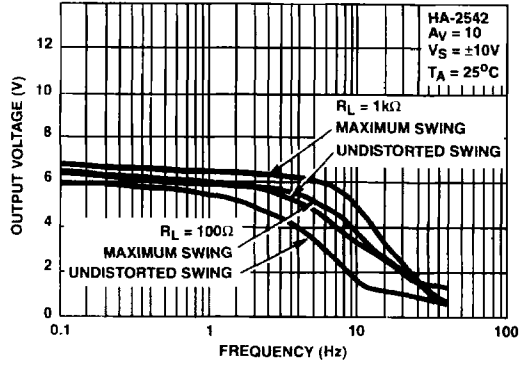

FIGURE 19. OUTPUT VOLTAGE SWING vs FREQUENCY

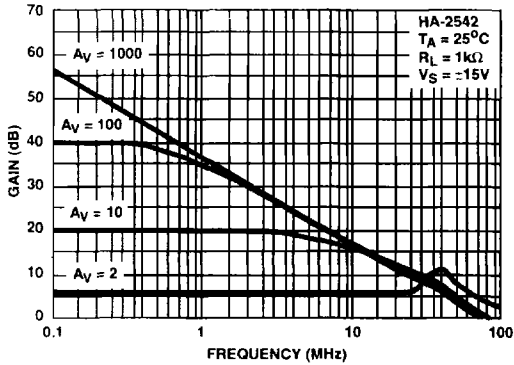

FIGURE 20. FREQUENCY RESPONSE CURVES

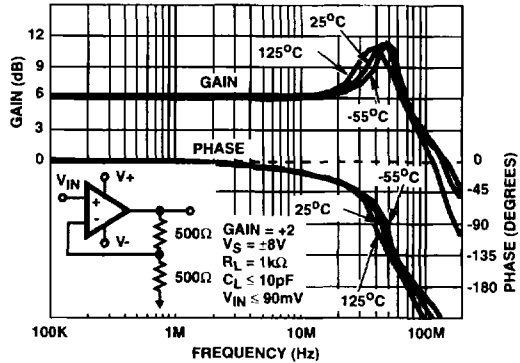

FIGURE 21. HA-2542 CLOSED LOOP GAIN vs TEMPERATURE

HA-2542

Die Characteristics

DIE DIMENSIONS:

106 mils x 73 mils x 19 mils
2700 μ m x 1850 μ m x 483 μ m

METALLIZATION:

Type: Al, 1% Cu
Thickness: 16k \AA \pm 2k \AA

PASSIVATION

Type: Nitride (Si₃N₄) over Silox (SiO₂, 5% Phos.)
Silox Thickness: 12k \AA \pm 2k \AA
Nitride Thickness: 3.5k \AA \pm 1.5k \AA

SUBSTRATE POTENTIAL (Powered Up):

V-

TRANSISTOR COUNT:

43

PROCESS:

Bipolar Dielectric Isolation

Metallization Mask Layout

