

<p>GlobTek, Inc. www.globtek.com 186 Veterans Drive, Northvale, NJ 07647 Tel. (201) 784-1000 Fax (201) 784-0111</p>	<p>Drawing Title: GTM96183-36PD-USB1C, USB Adaptive Power Source ICT/ITE/Medical Power supply, Efficiency Level: USA DOE Level VI / Eco-design Directive 2009/125/EC, (EU) 2019/1782, Case Color/Style: GlobTek Black, Wall Plug-in, USB Adaptive Power Supply AC Adaptor, Input Rating: 100-240V~, 50-60 Hz, Interchangeable Blades http://en.globtek.com/interchangeable-blades.php, Output Rating: 36W, 5.0V, 5.8V, 9.0V, 12.0V, 15.0V, 15.1V, 20.0VV@3.0A, 3.0A, 3.0A, 3.0A, 2.4A, 2.38A, 1.8AA, Output Configuration: N/A mm, N/A/ Cond, N/A, Type "C" USB "JACK", integral to power supply enclosure compliant with Directive (EU) 2022/2380 and 2014/53/EU Radio Equipment Directive (RED), Ferrite: None, N/A, GT Cord # C40133, Pin Out: A1, A12, B1, B12: COM A4, A9, B4, B9: V+ CC1:A5, D+ :A6 D- : A7, Blades/Input Cord: Not Applicable, Approvals: UKCA; Morocco; PSE; CAN ICES-3; RCM (pending); China RoHS; Level VI; CB 60601-1 (pending); LPS 62368; RoHS; Ukraine; VCCI; WEEE; Double Insulation; CCC (pending); FCC; cETLus 60601-1 3rd (pending); 230V CoC Tier 2; CB 60950 (pending); CB 62368; EAC;ccc;</p>	
	<p>Model No. GTM96183-36PD-USB1C</p>	
	<p>Part No./Ordering No. WR9QZ1800USBCFG2R6B</p>	<p>Rev A3</p>

In Addition to GlobTek Inc.'s renewed ISO9001:2015 - Quality Management System Certification, GlobTek Inc. is now certified to:

ISO13485:2016 - Medical Devices Quality Management System Certification

ISO14001:2015 - Environmental Management System Certification

ISO Certificates are available online at <https://www.globtek.com/iso-certificates/>

The acceptance of this specification and use of the product described in this document indicates the acceptance and binding of the customer to Globtek TERMS AND CONDITIONS (attached to the end of this document), which supersede all other agreements, terms, and conditions (<https://en.globtek.com/terms-and-conditions/>).

The purchaser of this product (Customer) agrees that it is their sole responsibility to determine suitability/fitness of the product described in this specification for their application and to take precautions for protection against any hazards attendant to the handling and use of the product.

Footnote:

GlobTek Inc. will not be liable for the safety and performance of these power supplies/battery packs if unauthorized access and repair occurs. End user should consult applicable UL, CSA or EN standards for proper installation instruction.

Limitation of Use:

GlobTek products are intended for use with commercial, medical, and/or industrial equipment only. GlobTek product are not authorized for use as mission critical components in life support hazardous environment, nuclear or aircraft applications without prior written approval from the CEO of GlobTek Inc.

Contents of this document are subject to change without prior notice.

Customer Approval of Specification:

Please approve, sign and send back to GlobTek so we can complete order processing.

A delay in receipt of this form will delay delivery schedule.

Company Name: _____	Customer P/N: _____
Quote Number: _____	Date: _____
Authorized Representative Name: _____	Authorized Representative Signature: _____

GlobTek, Inc. www.globtek.com 186 Veterans Drive, Northvale, NJ 07647 Tel. (201) 784-1000 Fax (201) 784-0111	Drawing Title: GTM96183-36PD-USB1C, USB Adaptive Power Source ICT/ITE/Medical Power supply, Efficiency Level: USA DOE Level VI / Eco-design Directive 2009/125/EC, (EU) 2019/1782, Case Color/Style: GlobTek Black, Wall Plug-in, USB Adaptive Power Supply AC Adaptor, Input Rating: 100-240V~, 50-60 Hz, Interchangeable Blades http://en.globtek.com/interchangeable-blades.php , Output Rating: 36W, 5.0V, 5.8V, 9.0V, 12.0V, 15.0V, 15.1V, 20.0VV@3.0A, 3.0A, 3.0A, 3.0A, 2.4A, 2.38A, 1.8AA, Output Configuration: N/A mm, N/A/ Cond, N/A, Type "C" USB "JACK", integral to power supply enclosure compliant with Directive (EU) 2022/2380 and 2014/53/EU Radio Equipment Directive (RED), Ferrite: None, N/A, GT Cord # C40133, Pin Out: A1, A12, B1, B12: COM A4, A9, B4, B9: V+ CC1:A5, D+ :A6 D- : A7, Blades/Input Cord: Not Applicable, Approvals: UKCA; Morocco; PSE; CAN ICES-3; RCM (pending); China RoHS; Level VI; CB 60601-1 (pending); LPS 62368; RoHS; Ukraine; VCCI; WEEE; Double Insulation; CCC (pending); FCC; cETLus 60601-1 3rd (pending); 230V CoC Tier 2; CB 60950 (pending); CB 62368; EAC;cco;	
	Model No. GTM96183-36PD-USB1C	
	Part No./Ordering No. WR9QZ1800USBCFG2R6B	Rev A3

REVISION HISTORY

REV	DESCRIPTION	SUB	DATE	APPROVED
A3	Update Firmware from GTF-7440-1 to GTF-7483-1	QA	04/05/2023	QA
A2	Add Firmware GTF-7440-1 to Power supply Information	QA	01/04/2022	QA
A1	Update packing: Qty to 120 pcs, master carton dimensions to 380*380*250 mm	QA	04/20/2021	QA
A	Initial release	krakoM	03/04/2020	QA

POWER SUPPLY INFORMATION

TYPE	Wall Plug-in
TECHNOLOGY	USB Adaptive Power Supply AC Adaptor
FIRMWARE VER	GTF-7483-1
CASE COLOR	GlobTek Black
NAMEPLATE RATED INPUT	100-240V~, 50-60 Hz, 0.6A
INPUT CONFIG	Interchangeable Blades
WATTS	36.00
VOLTS OUT	5.0V, 5.8V, 9.0V, 12.0V, 15.0V, 15.1V, 20.0V
CURRENT OUT (Amps)	3.0A, 3.0A, 3.0A, 3.0A, 2.4A, 2.38A, 1.8A
BLADE/CORD INCLUDED	N/A Not Applicable
BLADE/CORD INSTALLED	N/A :Not Applicable
INGRESS PROTECTION	Indoor Use
GROUNDING CONFIGURATION	(F1) Class II / Double Insulated
EFFICIENCY LEVEL	USA DOE Level VI / Eco-design Directive 2009/125/EC, (EU) 2019/1782
OUTPUT CONFIGURATION	N/A mm, N/A/ Cond, N/A, Type "C" USB "JACK", integral to power supply enclosure compliant with Directive (EU) 2022/2380 and 2014/53/EU Radio Equipment Directive (RED), Ferrite: None, N/A, GT Cord # C40133
OVERMOLDED	No
OUTPUT CONNECTOR GENDER	Female
CONNECTOR PIN OUT	A1, A12, B1, B12: COM A4, A9, B4, B9: V+ CC1:A5, D+ :A6 D- : A7
LABEL SPECS	ISO 15223 medical device compliant label,L-1470
SPECIAL BARCODE LABEL MATERIAL	No
PACK SPEC	Standard, Cellular packaging
USER MANUAL	

PROPRIETARY INFORMATION

<p>GlobTek, Inc. www.globtek.com 186 Veterans Drive, Northvale, NJ 07647 Tel. (201) 784-1000 Fax (201) 784-0111</p>	<p>Drawing Title: GTM96183-36PD-USB1C, USB Adaptive Power Source ICT/ITE/Medical Power supply, Efficiency Level: USA DOE Level VI / Eco-design Directive 2009/125/EC, (EU) 2019/1782, Case Color/Style: GlobTek Black, Wall Plug-in, USB Adaptive Power Supply AC Adaptor, Input Rating: 100-240V~, 50-60 Hz, Interchangeable Blades http://en.globtek.com/interchangeable-blades.php, Output Rating: 36W, 5.0V, 5.8V, 9.0V, 12.0V, 15.0V, 15.1V, 20.0VV@3.0A, 3.0A, 3.0A, 3.0A, 2.4A, 2.38A, 1.8AA, Output Configuration: N/A mm, N/A/ Cond, N/A, Type "C" USB "JACK", integral to power supply enclosure compliant with Directive (EU) 2022/2380 and 2014/53/EU Radio Equipment Directive (RED), Ferrite: None, N/A, GT Cord # C40133, Pin Out: A1, A12, B1, B12: COM A4, A9, B4, B9: V+ CC1:A5, D+ :A6 D- : A7, Blades/Input Cord: Not Applicable, Approvals: UKCA; Morocco; PSE; CAN ICES-3; RCM (pending); China RoHS; Level VI; CB 60601-1 (pending); LPS 62368; RoHS; Ukraine; VCCI; WEEE; Double Insulation; CCC (pending); FCC; cETLus 60601-1 3rd (pending); 230V CoC Tier 2; CB 60950 (pending); CB 62368; EAC;ccc;</p>	
	<p>Model No. GTM96183-36PD-USB1C</p>	
	<p>Part No./Ordering No. WR9QZ1800USBCFG2R6B</p>	<p>Rev A3</p>

Notes/Modifications/Customizations (notes in this section supersede the values shown in the standard spec)
DIMENSIONS ARE IN MM UNLESS SPECIFIED OTHERWISE

GloTek, Inc. www.globtek.com 186 Veterans Drive, Northvale, NJ 07647 Tel. (201) 784-1000 Fax (201) 784-0111	Drawing Title: GTM96183-36PD-USB1C, USB Adaptive Power Source ICT/ITE/Medical Power supply, Efficiency Level: USA DOE Level VI / Eco-design Directive 2009/125/EC, (EU) 2019/1782, Case Color/Style: GloTek Black, Wall Plug-in, USB Adaptive Power Supply AC Adaptor, Input Rating: 100-240V~, 50-60 Hz, Interchangeable Blades http://en.globtek.com/interchangeable-blades.php , Output Rating: 36W, 5.0V, 5.8V, 9.0V, 12.0V, 15.0V, 15.1V, 20.0VV@3.0A, 3.0A, 3.0A, 2.4A, 2.38A, 1.8AA, Output Configuration: N/A mm, N/A/ Cond, N/A, Type "C" USB "JACK", integral to power supply enclosure compliant with Directive (EU) 2022/2380 and 2014/53/EU Radio Equipment Directive (RED), Ferrite: None, N/A, GT Cord # C40133, Pin Out: A1, A12, B1, B12: COM A4, A9, B4, B9: V+ CC1:A5, D+ :A6 D- : A7, Blades/Input Cord: Not Applicable, Approvals: UKCA; Morocco; PSE; CAN ICES-3; RCM (pending); China RoHS; Level VI; CB 60601-1 (pending); LPS 62368; RoHS; Ukraine; VCCI; WEEE; Double Insulation; CCC (pending); FCC; cETLus 60601-1 3rd (pending); 230V CoC Tier 2; CB 60950 (pending); CB 62368; EAC;ccc;	
	Model No. GTM96183-36PD-USB1C	
	Part No./Ordering No. WR9QZ1800USBCFG2R6B	Rev A3

ELECTRICAL SPECIFICATIONS

USB Power Delivery Capabilities

Protocol supported:	USB Power Delivery (PD) 2.0/3.0 + PPS
Advertised Power Data Objects (PDOs/APDOs):	Standard option: 5V, 5.8V, 9V, 12V, 15V, 15.1V, 20V PPS option (18W): 5V, 9V, 12V, 15V, 15.1V, 20V, PPS (5-21V) PPS option (36W): 5V, 9V, 15V, 20V, PPS (5-11V), PPS (5-16V), PPS (5-21V)
Note 1:	Custom fixed PDOs available upon request. PDO1 must be 5V. PDO2 through PDO7 may be set to any custom voltage from 5V to 20V, with a step size of 100mV.
Note 2:	In critical applications, the use of a non-authorized USB PD power supply may pose a substantial risk. Power supply authorization may be implemented using USB PD Vendor Defined Messages (VDMs) to prevent system operation with non-authorized power sources. Please see our article Product Security and Risk Mitigation for USB Power Delivery (PD) Based Systems for additional information.

Input

Input Voltage:	Specified: 90-264VAC, Nameplate: 100-240VAC 100% rated load current for 90-264VAC 85% rated load current for 85-264VAC 100% rated load current for 110-370VDC
Input Frequency:	Specified: 47-63Hz, Nameplate: 50-60Hz
No Load Input Power:	< 75mW @ 230VAC (EU CoC Tier 2 compliant)
Inrush Current:	< 30A @ 115VAC, < 60A @ 230VAC (cold start)
Efficiency:	DoE Efficiency Level VI and CoC Tier 2 compliant (tested according to DoE 10 CFR Part 430, Subpart B, Appendix Z)

Output

Turn-on Delay:	< 1 second @ 115VAC and full load
Output Regulation	± 4% max. (measured at the end of a 1m long output cord)
Line Regulation:	± 0.5% typ. (measured at the end of a 1m long output cord)
Ripple:	100mV max. (using a 47µF low-ESR electrolytic cap + 0.1µF ceramic cap, measured @ 20MHz BW, at the output connector)
Transient Response:	5% max. deviation, 1ms max. recovery time (with 25% load step),
Hold-up Time:	8ms min. (100VAC and full load)
Power Indicator:	Green LED

Protections

Input Protection:	MOV transient suppressor, input line fusing
-------------------	---

PROPRIETARY INFORMATION

PROPRIETARY OF GLOBTEK, INC. ANY REPRODUCTION, DISCLOSURE OR USE OF THIS DRAWING, IN WHOLE OR IN PART, IS HEREBY PROHIBITED EXCEPT AS SPECIFIED IN WRITING BY GLOBTEK, INC. © GlobTek, Inc. 2020 - 2023

GlobTek, Inc. www.globtek.com 186 Veterans Drive, Northvale, NJ 07647 Tel. (201) 784-1000 Fax (201) 784-0111	Drawing Title: GTM96183-36PD-USB1C, USB Adaptive Power Source ICT/ITE/Medical Power supply, Efficiency Level: USA DOE Level VI / Eco-design Directive 2009/125/EC, (EU) 2019/1782, Case Color/Style: GlobTek Black, Wall Plug-in, USB Adaptive Power Supply AC Adaptor, Input Rating: 100-240V~, 50-60 Hz, Interchangeable Blades http://en.globtek.com/interchangeable-blades.php , Output Rating: 36W, 5.0V, 5.8V, 9.0V, 12.0V, 15.0V, 15.1V, 20.0VV@3.0A, 3.0A, 3.0A, 2.4A, 2.38A, 1.8AA, Output Configuration: N/A mm, N/A/ Cond, N/A, Type "C" USB "JACK", integral to power supply enclosure compliant with Directive (EU) 2022/2380 and 2014/53/EU Radio Equipment Directive (RED), Ferrite: None, N/A, GT Cord # C40133, Pin Out: A1, A12, B1, B12: COM A4, A9, B4, B9: V+ CC1:A5, D+ :A6 D- : A7, Blades/Input Cord: Not Applicable, Approvals: UKCA; Morocco; PSE; CAN ICES-3; RCM (pending); China RoHS; Level VI; CB 60601-1 (pending); LPS 62368; RoHS; Ukraine; VCCI; WEEE; Double Insulation; CCC (pending); FCC; cETLus 60601-1 3rd (pending); 230V CoC Tier 2; CB 60950 (pending); CB 62368; EAC;ccc;	
	Model No. GTM96183-36PD-USB1C	
	Part No./Ordering No. WR9QZ1800USBCFG2R6B	Rev A3

Over-Voltage Protection:	Level 1: 110-130%, Auto-recovery, adaptive to selected PDO Level 2: 24-28V, Latched off, cycle AC to reset
Over-Current Protection:	110-130%, Auto-recovery, adaptive to selected PDO
Short-Circuit Protection:	Auto-recovery
Over-Temperature Protection:	Auto-recovery

Environmental

MTBF:	1,500,000 hours @ 25°C ambient, full load (Telcordia SR-332, Issue 3)
Operating Temperature:	-10°C to 40°C (full load)
Storage Temperature:	-40°C to 80°C
Humidity:	0% to 95% relative humidity, non-condensing
Altitude	5000m
Cooling:	Convection
RoHS:	Complies with EU 2011/65/EU and China SJ/T 11363-2006

Safety

Dielectric Withstand Voltage:	4000VAC or 5656VDC from input to output 10mA, 1 minute
Touch Current:	NC: 80µA max. SFC: 400µA max.
Earth Leakage Current	300µA max. NC/SFC (N/A for 2-conductor input models)
Means of Protection:	2 x MOPP
Output Isolation Options:	-Q suffix: Class II 2-conductor (interchangeable blades) -T2 suffix: Class II 2-conductor -T3 suffix: Class II, with functional earth (FE) Class I, earth wire connected directly to output negative
Note 3:	Review output isolation options with our article: PSU Isolation and Identify

EMC

Applicable Standards:	Medical: EN 60601-1-2 (4e) Emissions: EN55032, EN61000-6-3, EN61000-6-4 Immunity: EN55024, EN61000-6-1 (4e), EN61000-6-2 (4e)
Conducted Emissions:	Class B, FCC Part 15, Class B (with resistive load)
Radiated Emissions:	Class B, FCC Part 15, Class B (with resistive load)
Harmonic Current Voltage Distortion:	EN61000-3-2, Class A
Voltage Fluctuations/Flicker:	EN61000-3-3
Electrostatic Discharge (ESD) Immunity:	EN61000-4-2, 10KV contact discharge, 18KV air discharge, Criterion A
Radiated RF Immunity:	EN61000-4-3, 10V/m @ 80-1000MHz, 3V/m @ 1-2.7GHz, 80% 1KHz AM, Criterion A
EFT/Burst Immunity:	EN61000-4-4, 4KV/100KHz., Criterion A

GlobTek, Inc. www.globtek.com 186 Veterans Drive, Northvale, NJ 07647 Tel. (201) 784-1000 Fax (201) 784-0111	Drawing Title: GTM96183-36PD-USB1C, USB Adaptive Power Source ICT/ITE/Medical Power supply, Efficiency Level: USA DOE Level VI / Eco-design Directive 2009/125/EC, (EU) 2019/1782, Case Color/Style: GlobTek Black, Wall Plug-in, USB Adaptive Power Supply AC Adaptor, Input Rating: 100-240V~, 50-60 Hz, Interchangeable Blades http://en.globtek.com/interchangeable-blades.php , Output Rating: 36W, 5.0V, 5.8V, 9.0V, 12.0V, 15.0V, 15.1V, 20.0VV@3.0A, 3.0A, 3.0A, 2.4A, 2.38A, 1.8AA, Output Configuration: N/A mm, N/A/ Cond, N/A, Type "C" USB "JACK", integral to power supply enclosure compliant with Directive (EU) 2022/2380 and 2014/53/EU Radio Equipment Directive (RED), Ferrite: None, N/A, GT Cord # C40133, Pin Out: A1, A12, B1, B12: COM A4, A9, B4, B9: V+ CC1:A5, D+ :A6 D- : A7, Blades/Input Cord: Not Applicable, Approvals: UKCA; Morocco; PSE; CAN ICES-3; RCM (pending); China RoHS; Level VI; CB 60601-1 (pending); LPS 62368; RoHS; Ukraine; VCCI; WEEE; Double Insulation; CCC (pending); FCC; cETLus 60601-1 3rd (pending); 230V CoC Tier 2; CB 60950 (pending); CB 62368; EAC;ccc;	
	Model No. GTM96183-36PD-USB1C	
	Part No./Ordering No. WR9QZ1800USBCFG2R6B	Rev A3

Line Surge Immunity:	EN61000-4-5, 2KV differential, 4KV common-mode, Criterion A
Conducted RF Immunity:	EN61000-4-6, 10VRMS, 80% 1KHz AM, Criterion A
Voltage Dip Immunity:	EN61000-4-11, Criterion B/C
Note 4:	When a Class II power supply is connected to an earth-referenced system, conducted/radiated EMI levels tend to increase since the distant earth connection creates a long return path for common-mode EMI currents. This model includes an output common-mode choke to help alleviate system-level EMI issues. This choke can be removed for cost-sensitive applications.

Enclosure

Housing:	High impact plastic, 94V0 polycarbonate, non-vented
Markings:	Adhesive backed label or laser engraving

Security

USB Power Delivery:	Two non-standard voltage profiles are included: 5.8V and 15.1V. System designers may use these non-standard profiles to reduce the likelihood of system operation with non-GlobTek power supplies. 12.0V is also not standard, but is often included in other power supplies.
Note 5:	The power supply will respond to a USB PD "Discover Identity" VDM with 0x4754 in the "ProductID" field. USB PD host systems may check this value before initiating/allowing power negotiation. These measures do not guarantee a secure implementation, and are only suggested as a method of risk mitigation.
Note 6:	Please see our article Product Security and Risk Mitigation for USB Power Delivery (PD) Based Systems for additional information.

Special Options

Non-standard - Contact GlobTek

1. Custom housing and output cord colors
2. Custom fixed output cord length, for applicable models (1m, 2m, 3m lengths)
3. Custom markings and marking methods
4. Custom USB PD PDOs: Output voltages selectable between 5V and 20V, in 100mV increments

TO ADDRESS SYSTEM-LEVEL EMI CONCERNS, FERRITE CHOKES/BEADS MAY BE ADDED/REVISED UPON REQUEST. A SAMPLE KIT OF GLOBTEK'S STANDARD FERRITES IS AVAILABLE UNDER GLOBTEK P/N: EMI-MITIGATION-KIT1

FOR ADDITIONAL INFORMATION, PLEASE READ OUR WHITE PAPER AT: <https://r.globtek.info/3QeaqtD>

INGRESS PROTECTION: Indoor Use

<p>GlobTek, Inc. www.globtek.com 186 Veterans Drive, Northvale, NJ 07647 Tel. (201) 784-1000 Fax (201) 784-0111</p>	<p>Drawing Title: GTM96183-36PD-USB1C, USB Adaptive Power Source ICT/ITE/Medical Power supply, Efficiency Level: USA DOE Level VI / Eco-design Directive 2009/125/EC, (EU) 2019/1782, Case Color/Style: GlobTek Black, Wall Plug-in, USB Adaptive Power Supply AC Adaptor, Input Rating: 100-240V~, 50-60 Hz, Interchangeable Blades http://en.globtek.com/interchangeable-blades.php, Output Rating: 36W, 5.0V, 5.8V, 9.0V, 12.0V, 15.0V, 15.1V, 20.0VV@3.0A, 3.0A, 3.0A, 3.0A, 2.4A, 2.38A, 1.8AA, Output Configuration: N/A mm, N/A/ Cond, N/A, Type "C" USB "JACK", integral to power supply enclosure compliant with Directive (EU) 2022/2380 and 2014/53/EU Radio Equipment Directive (RED), Ferrite: None, N/A, GT Cord # C40133, Pin Out: A1, A12, B1, B12: COM A4, A9, B4, B9: V+ CC1:A5, D+ :A6 D- : A7, Blades/Input Cord: Not Applicable, Approvals: UKCA; Morocco; PSE; CAN ICES-3; RCM (pending); China RoHS; Level VI; CB 60601-1 (pending); LPS 62368; RoHS; Ukraine; VCCI; WEEE; Double Insulation; CCC (pending); FCC; cETLus 60601-1 3rd (pending); 230V CoC Tier 2; CB 60950 (pending); CB 62368; EAC;ccc;</p>	
	<p>Model No. GTM96183-36PD-USB1C</p>	
	<p>Part No./Ordering No. WR9QZ1800USBCFG2R6B</p>	<p>Rev A3</p>

3D File Download <https://www.globtek.com/file/dl/gtm96183-wwpd-usb1c-q.stp>

Mechanical drawing

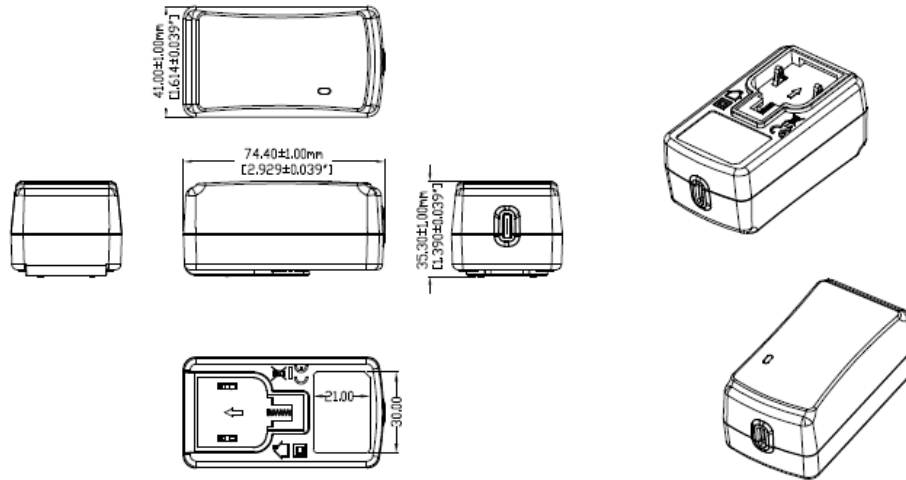

<p>GlobTek, Inc. www.globtek.com 186 Veterans Drive, Northvale, NJ 07647 Tel. (201) 784-1000 Fax (201) 784-0111</p>	<p>Drawing Title: GTM96183-36PD-USB1C, USB Adaptive Power Source ICT/ITE/Medical Power supply, Efficiency Level: USA DOE Level VI / Eco-design Directive 2009/125/EC, (EU) 2019/1782, Case Color/Style: GlobTek Black, Wall Plug-in, USB Adaptive Power Supply AC Adaptor, Input Rating: 100-240V~, 50-60 Hz, Interchangeable Blades http://en.globtek.com/interchangeable-blades.php, Output Rating: 36W, 5.0V, 5.8V, 9.0V, 12.0V, 15.0V, 15.1V, 20.0VV@3.0A, 3.0A, 3.0A, 3.0A, 2.4A, 2.38A, 1.8AA, Output Configuration: N/A mm, N/A/ Cond, N/A, Type "C" USB "JACK", integral to power supply enclosure compliant with Directive (EU) 2022/2380 and 2014/53/EU Radio Equipment Directive (RED), Ferrite: None, N/A, GT Cord # C40133, Pin Out: A1, A12, B1, B12: COM A4, A9, B4, B9: V+ CC1:A5, D+ :A6 D- : A7, Blades/Input Cord: Not Applicable, Approvals: UKCA; Morocco; PSE; CAN ICES-3; RCM (pending); China RoHS; Level VI; CB 60601-1 (pending); LPS 62368; RoHS; Ukraine; VCCI; WEEE; Double Insulation; CCC (pending); FCC; cETLus 60601-1 3rd (pending); 230V CoC Tier 2; CB 60950 (pending); CB 62368; EAC;ccc;</p>	
	<p>Model No. GTM96183-36PD-USB1C</p>	
	<p>Part No./Ordering No. WR9QZ1800USBCFG2R6B</p>	<p>Rev A3</p>

DERATING CURVE

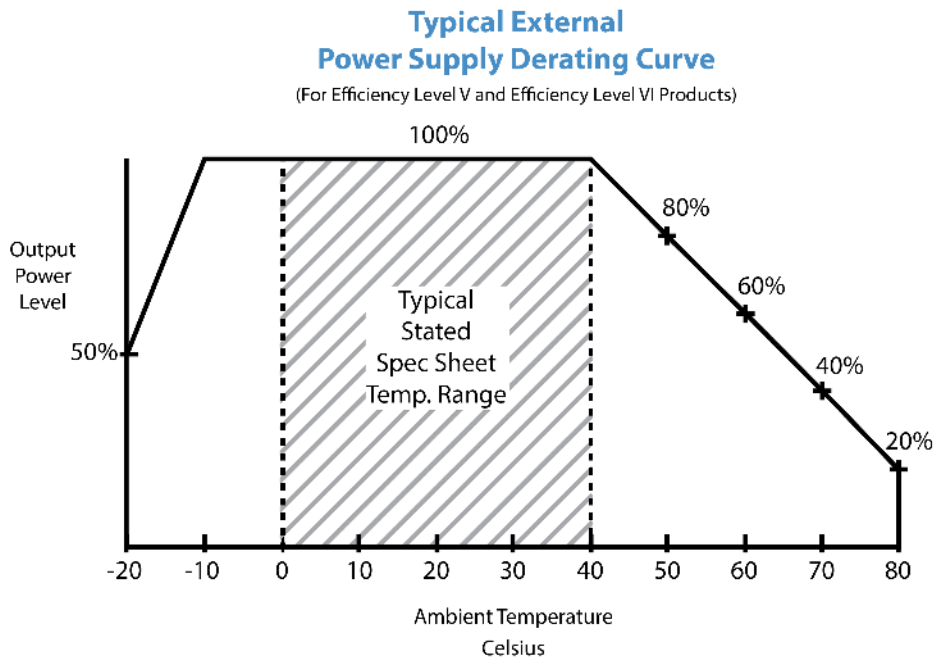

<p>GlobTek, Inc. www.globtek.com 186 Veterans Drive, Northvale, NJ 07647 Tel. (201) 784-1000 Fax (201) 784-0111</p>	<p>Drawing Title: GTM96183-36PD-USB1C, USB Adaptive Power Source ICT/ITE/Medical Power supply, Efficiency Level: USA DOE Level VI / Eco-design Directive 2009/125/EC, (EU) 2019/1782, Case Color/Style: GlobTek Black, Wall Plug-in, USB Adaptive Power Supply AC Adaptor, Input Rating: 100-240V~, 50-60 Hz, Interchangeable Blades http://en.globtek.com/interchangeable-blades.php, Output Rating: 36W, 5.0V, 5.8V, 9.0V, 12.0V, 15.0V, 15.1V, 20.0VV@3.0A, 3.0A, 3.0A, 3.0A, 2.4A, 2.38A, 1.8AA, Output Configuration: N/A mm, N/A/ Cond, N/A, Type "C" USB "JACK", integral to power supply enclosure compliant with Directive (EU) 2022/2380 and 2014/53/EU Radio Equipment Directive (RED), Ferrite: None, N/A, GT Cord # C40133, Pin Out: A1, A12, B1, B12: COM A4, A9, B4, B9: V+ CC1:A5, D+ :A6 D- : A7, Blades/Input Cord: Not Applicable, Approvals: UKCA; Morocco; PSE; CAN ICES-3; RCM (pending); China RoHS; Level VI; CB 60601-1 (pending); LPS 62368; RoHS; Ukraine; VCCI; WEEE; Double Insulation; CCC (pending); FCC; cETLus 60601-1 3rd (pending); 230V CoC Tier 2; CB 60950 (pending); CB 62368; EAC;ccc;</p>	
	<p>Model No. GTM96183-36PD-USB1C</p>	
	<p>Part No./Ordering No. WR9QZ1800USBCFG2R6B</p>	<p>Rev A3</p>

INPUT CONFIGURATION

(F1) Class II / Double Insulated



[Alternate grounding configurations](#) available upon request.

Blades/Cord Included:N/A:Not Applicable

Blades/Cord Installed:N/A:Not Applicable

Blade Options for Q Series Wall Plug-in Power Supplies

Data Sheet: <http://en.globtek.com/interchangeable-blades.php>

Insertion Instructions: <http://www.globtek.com/pdf/Instructions-Interchangeable-Blades.pdf>

Video: [Q-Blade Style Instruction Video](#)

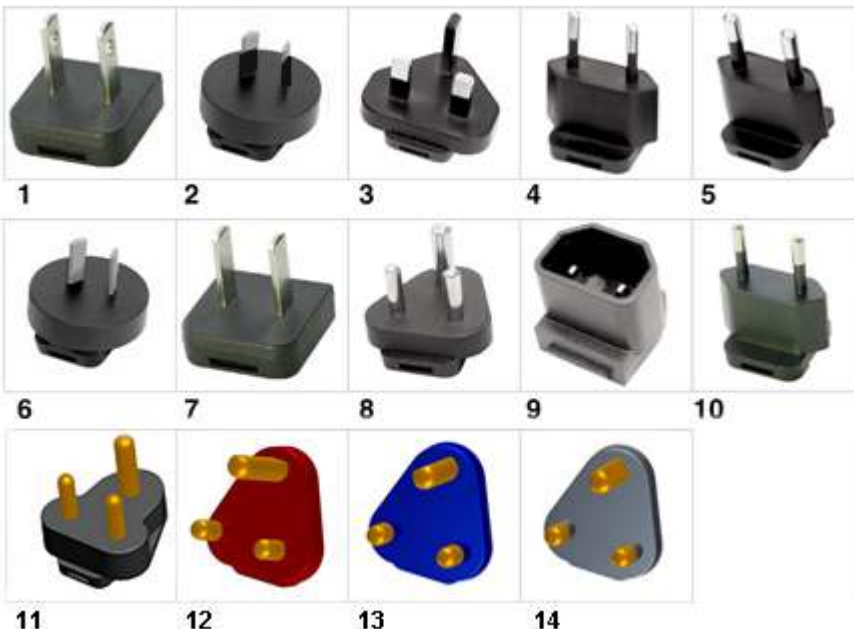

GloBtek, Inc. www.globtek.com 186 Veterans Drive, Northvale, NJ 07647 Tel. (201) 784-1000 Fax (201) 784-0111	Drawing Title: GTM96183-36PD-USB1C, USB Adaptive Power Source ICT/ITE/Medical Power supply, Efficiency Level: USA DOE Level VI / Eco-design Directive 2009/125/EC, (EU) 2019/1782, Case Color/Style: GloBtek Black, Wall Plug-in, USB Adaptive Power Supply AC Adaptor, Input Rating: 100-240V~, 50-60 Hz, Interchangeable Blades http://en.globtek.com/interchangeable-blades.php , Output Rating: 36W, 5.0V, 5.8V, 9.0V, 12.0V, 15.0V, 15.1V, 20.0VV@3.0A, 3.0A, 3.0A, 2.4A, 2.38A, 1.8AA, Output Configuration: N/A mm, N/A/ Cond, N/A, Type "C" USB "JACK", integral to power supply enclosure compliant with Directive (EU) 2022/2380 and 2014/53/EU Radio Equipment Directive (RED), Ferrite: None, N/A, GT Cord # C40133, Pin Out: A1, A12, B1, B12: COM A4, A9, B4, B9: V+ CC1:A5, D+ :A6 D- : A7, Blades/Input Cord: Not Applicable, Approvals: UKCA; Morocco; PSE; CAN ICES-3; RCM (pending); China RoHS; Level VI; CB 60601-1 (pending); LPS 62368; RoHS; Ukraine; VCCI; WEEE; Double Insulation; CCC (pending); FCC; cETLus 60601-1 3rd (pending); 230V CoC Tier 2; CB 60950 (pending); CB 62368; EAC;ccc;	
	Model No. GTM96183-36PD-USB1C	
	Part No./Ordering No. WR9QZ1800USBCFG2R6B	Rev A3

INPUT CONNECTOR: Q-Socket (below are available blades configurations which are "not included" (unless stated above); can be purchased separately, package with power supply or as a separate "Q-KIT" if specified

01. United States / Canada / Japan NEMA 1-15P/ IEC PLUG Type A [WORKS IN PLUG B] configuration: NA 2 blades, Class II; US/CA/JP P/N: Q-NA(R)
02. Australian AS 3112 configuration: SAA 2 blade/ IEC TYPE I, Class II; AU P/N: Q-SAA(R)
03. UK BS 1363 configuration: UK 3 blade with dummy Ground/ IEC TYPE G, Class II; GB P/N: Q-UK(R)
04. European CEE 7/16 configuration: Europlug 2 pins/ IEC TYPE C [WORKS IN TYPE E&F], Class II; EU P/N: Q-EU(R)
05. Korean KS C8305 configuration: 2 pins/SIMILAR TO IEC TYPE C, Class II; KR P/N: Q-KR(R)
06. Argentina IRAM 2073 configuration: 2 blades/SIMILAR TO IEC TYPE I; AR P/N: Class II Q-AR(R)
07. China GB 2099 configuration: 2 blades/SIMILAR TO TYPE A, Class II; CN P/N:Q-CN(R)
08. India IS 1293 6A/BS546 configuration: 5A, 3 pins with Dummy Ground, Class II/IEC TYPE D; IN P/N: Q-IN(R)
09. IEC60320/C18 Inlet, Class II; P/N: Q-C18(R)
10. Brazilian NBR6147 configuration: 2 pins, Class II;SIMILAR TO IEC TYPE C BR P/N: Q-BR(R)
11. South Africa SABS164-1 and India IS 1293, IS694, 16A type plug, 3 round prongs, Class II + dummy ground, IEC TYPE M P/N: Q-SANS164-1-16A(R)
12. South Africa SABS164-4, 3 round prongs with a notched prong @ 0°, Class II + dummy ground, IEC TYPE M Red, P/N: Q-SANS164-4C-16A(R)
13. South Africa SABS164-4, 3 round prongs with a notched prong @ -53°, Class II + dummy ground, Blue, IEC TYPE M, P/N: Q-SANS164-4L-16A(R)
14. South Africa SABS164-4, 3 round prongs with a notched prong @ +53°, Class II + dummy ground, Black,IEC TYPE M P/N: Q-SANS164-4R-16A(R)

Kits

01. Q-KIT: 1,2,3,4 above
02. Q-KIT-INTL: 2,3,4 above
03. Q-KIT-6: 1,2,3,4,5,6 above
04. Q-KIT-7: 1,2,3,4,5,6,7 above
05. Q-KIT-8: 1,2,3,4,5,6,7,8 above

GlobTek, Inc. www.globtek.com 186 Veterans Drive, Northvale, NJ 07647 Tel. (201) 784-1000 Fax (201) 784-0111	Drawing Title: GTM96183-36PD-USB1C, USB Adaptive Power Source ICT/ITE/Medical Power supply, Efficiency Level: USA DOE Level VI / Eco-design Directive 2009/125/EC, (EU) 2019/1782, Case Color/Style: GlobTek Black, Wall Plug-in, USB Adaptive Power Supply AC Adaptor, Input Rating: 100-240V~, 50-60 Hz, Interchangeable Blades http://en.globtek.com/interchangeable-blades.php , Output Rating: 36W, 5.0V, 5.8V, 9.0V, 12.0V, 15.0V, 15.1V, 20.0VV@3.0A, 3.0A, 3.0A, 2.4A, 2.38A, 1.8AA, Output Configuration: N/A mm, N/A/ Cond, N/A, Type "C" USB "JACK", integral to power supply enclosure compliant with Directive (EU) 2022/2380 and 2014/53/EU Radio Equipment Directive (RED), Ferrite: None, N/A, GT Cord # C40133, Pin Out: A1, A12, B1, B12: COM A4, A9, B4, B9: V+ CC1:A5, D+ :A6 D- : A7, Blades/Input Cord: Not Applicable, Approvals: UKCA; Morocco; PSE; CAN ICES-3; RCM (pending); China RoHS; Level VI; CB 60601-1 (pending); LPS 62368; RoHS; Ukraine; VCCI; WEEE; Double Insulation; CCC (pending); FCC; cETLus 60601-1 3rd (pending); 230V CoC Tier 2; CB 60950 (pending); CB 62368; EAC;ccc;	
	Model No. GTM96183-36PD-USB1C	
	Part No./Ordering No. WR9QZ1800USBCFG2R6B	Rev A3

OUTPUT CORD AND CONNECTOR: USBCMT/C40133	
ACTUAL CONNECTORS, OVERMOLDS, FERRITES MAY VARY SLIGHTLY FROM THE PICTURE BELOW	
CABLE TYPE	N/A
CABLE LENGTH (mm)	N/A
CABLE TOLERANCE (mm)	N/A
WIRE GAUGE (AWG)	N/A
CONDUCTORS	
HANK DIMENSION (mm)	N/A
CABLE / CONNECTOR OVERMOLD COLOR	N/A
FERRITE TYPE AND DIMENSION	None
FERRITE NUMBER OF TURNS (Definition)	N/A
FERRITE DIMENSION FROM STRAIN RELIEF	N/A
FERRITE DIMENSION FROM PLUG	N/A
PLUG TYPE	Type "C" USB "JACK", integral to power supply enclosure compliant with Directive (EU) 2022/2380 and 2014/53/EU Radio Equipment Directive (RED)
OUTPUT CONNECTOR GENDER	Female
OVERMOLDED	No
OVER MOLD ORIENTATION	PCB Mount Connector
CONNECTOR PIN OUT	A1, A12, B1, B12: COM A4, A9, B4, B9: V+ CC1:A5, D+ :A6 D- : A7
ADDITIONAL OUTPUT PLUG OPTIONS ARE AVAILABLE AT https://www.globtek.com/connectors/ STANDARD PLUGS AND CONNECTORS CAN BE SEEN ONLINE AT https://www.globtek.com/connectors/ CALCULATE VOLTAGE REGULATION/DROP WITH OUR ONLINE CALCULATOR: https://en.globtek.com/output-cable-regulation-calculator/	

<p>GlobTek, Inc. www.globtek.com 186 Veterans Drive, Northvale, NJ 07647 Tel. (201) 784-1000 Fax (201) 784-0111</p>	<p>Drawing Title: GTM96183-36PD-USB1C, USB Adaptive Power Source ICT/ITE/Medical Power supply, Efficiency Level: USA DOE Level VI / Eco-design Directive 2009/125/EC, (EU) 2019/1782, Case Color/Style: GlobTek Black, Wall Plug-in, USB Adaptive Power Supply AC Adaptor, Input Rating: 100-240V~, 50-60 Hz, Interchangeable Blades http://en.globtek.com/interchangeable-blades.php, Output Rating: 36W, 5.0V, 5.8V, 9.0V, 12.0V, 15.0V, 15.1V, 20.0VV@3.0A, 3.0A, 3.0A, 2.4A, 2.38A, 1.8AA, Output Configuration: N/A mm, N/A/ Cond, N/A, Type "C" USB "JACK", integral to power supply enclosure compliant with Directive (EU) 2022/2380 and 2014/53/EU Radio Equipment Directive (RED), Ferrite: None, N/A, GT Cord # C40133, Pin Out: A1, A12, B1, B12: COM A4, A9, B4, B9: V+ CC1:A5, D+ :A6 D- : A7, Blades/Input Cord: Not Applicable, Approvals: UKCA; Morocco; PSE; CAN ICES-3; RCM (pending); China RoHS; Level VI; CB 60601-1 (pending); LPS 62368; RoHS; Ukraine; VCCI; WEEE; Double Insulation; CCC (pending); FCC; cETLus 60601-1 3rd (pending); 230V CoC Tier 2; CB 60950 (pending); CB 62368; EAC;ccc;</p>	
	<p>Model No. GTM96183-36PD-USB1C</p>	
	<p>Part No./Ordering No. WR9QZ1800USBCFG2R6B</p>	<p>Rev A3</p>

OUTPUT CONNECTOR HOOK UP

TO ADDRESS SYSTEM-LEVEL EMI CONCERNS, FERRITE CHOKES/BEADS MAY BE ADDED/REVISED UPON REQUEST. A SAMPLE KIT OF GLOBTEK'S STANDARD FERRITES IS AVAILABLE UNDER GLOBTEK P/N: EMI-MITIGATION-KIT1

FOR ADDITIONAL INFORMATION, PLEASE READ OUR WHITE PAPER AT:

<https://en.globtek.com/technical-articles/ferrite-kit-radiated-emi-suppression-kit-for-globtek-power-supplies-cable-assemblies>

GlobTek, Inc. www.globtek.com 186 Veterans Drive, Northvale, NJ 07647 Tel. (201) 784-1000 Fax (201) 784-0111	Drawing Title: GTM96183-36PD-USB1C, USB Adaptive Power Source ICT/ITE/Medical Power supply, Efficiency Level: USA DOE Level VI / Eco-design Directive 2009/125/EC, (EU) 2019/1782, Case Color/Style: GlobTek Black, Wall Plug-in, USB Adaptive Power Supply AC Adaptor, Input Rating: 100-240V~, 50-60 Hz, Interchangeable Blades http://en.globtek.com/interchangeable-blades.php , Output Rating: 36W, 5.0V, 5.8V, 9.0V, 12.0V, 15.0V, 15.1V, 20.0VV@3.0A, 3.0A, 3.0A, 3.0A, 2.4A, 2.38A, 1.8AA, Output Configuration: N/A mm, N/A/ Cond, N/A, Type "C" USB "JACK", integral to power supply enclosure compliant with Directive (EU) 2022/2380 and 2014/53/EU Radio Equipment Directive (RED), Ferrite: None, N/A, GT Cord # C40133, Pin Out: A1, A12, B1, B12: COM A4, A9, B4, B9: V+ CC1:A5, D+ :A6 D- : A7, Blades/Input Cord: Not Applicable, Approvals: UKCA; Morocco; PSE; CAN ICES-3; RCM (pending); China RoHS; Level VI; CB 60601-1 (pending); LPS 62368; RoHS; Ukraine; VCCI; WEEE; Double Insulation; CCC (pending); FCC; cETLus 60601-1 3rd (pending); 230V CoC Tier 2; CB 60950 (pending); CB 62368; EAC;cco;	
	Model No. GTM96183-36PD-USB1C	
	Part No./Ordering No. WR9QZ1800USBCFG2R6B	Rev A3

LABEL:L-1470





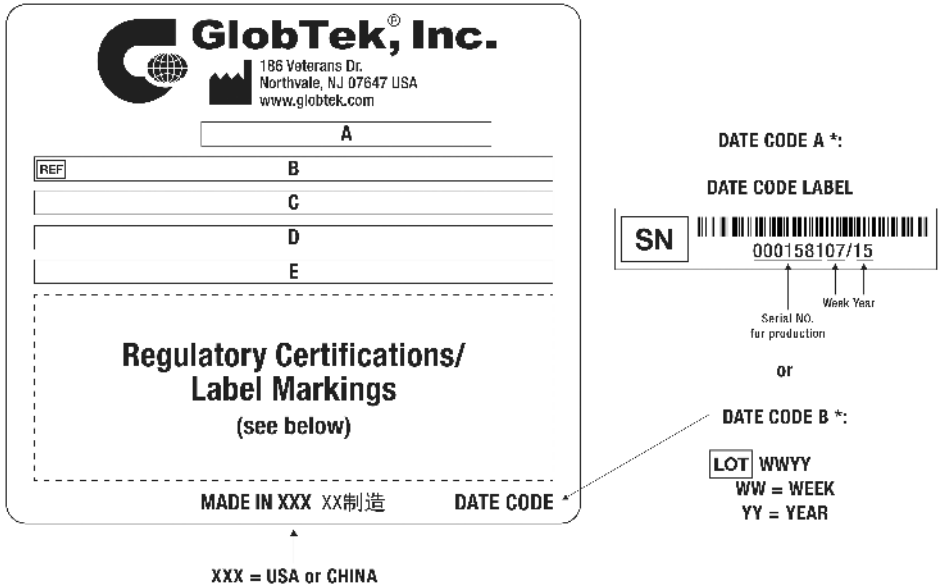

LABEL P/N	ISO 15223 medical device compliant label
MATERIAL	Flat Thermal Transfer, Imprintable, Polyester Label and/or Pad Printed and/or Molded, and/or Laser Engraved in the case
BACKGROUND COLOR	Black if housing is Black, White or Silver if housing is White or Gray.
TEXT COLOR	White or Silver if label is Black Background for Black housing. Black if label is White or Silver background and Housing is White or Gray.
LABEL WIDTH (mm)	28.5
LABEL HEIGHT (mm)	17.5
SPECIAL BARCODE LABEL MATERIAL	No

Below is the minimum information which will appear on the label. NOTE: in the logo area additional/actual positioning of symbols and text is subjected to change as per agency updates/requirements or additional model approvals become available. Agency logos may be in Regulatory Certifications/Label Markings area on the label or molded into the case housing outside the label area. Information will be shown via Label and/or Pad Printed and/or Molded in the case.



A=USB Adaptive Power Source ICT/ITE/Medical Power supply
 B=P/N: (料号) WR9QZ1800USBCFG2R6B
 C=Model (型号) GTM96183-36PD-USB1C
 D=Input (输入)100-240V~, 50-60 Hz, 0.6A

GloTek, Inc. www.globtek.com 186 Veterans Drive, Northvale, NJ 07647 Tel. (201) 784-1000 Fax (201) 784-0111	Drawing Title: GTM96183-36PD-USB1C, USB Adaptive Power Source ICT/ITE/Medical Power supply, Efficiency Level: USA DOE Level VI / Eco-design Directive 2009/125/EC, (EU) 2019/1782, Case Color/Style: GloTek Black, Wall Plug-in, USB Adaptive Power Supply AC Adaptor, Input Rating: 100-240V~, 50-60 Hz, Interchangeable Blades http://en.globtek.com/interchangeable-blades.php , Output Rating: 36W, 5.0V, 5.8V, 9.0V, 12.0V, 15.0V, 15.1V, 20.0VV@3.0A, 3.0A, 3.0A, 3.0A, 2.4A, 2.38A, 1.8AA, Output Configuration: N/A mm, N/A/ Cond, N/A, Type "C" USB "JACK", integral to power supply enclosure compliant with Directive (EU) 2022/2380 and 2014/53/EU Radio Equipment Directive (RED), Ferrite: None, N/A, GT Cord # C40133, Pin Out: A1, A12, B1, B12: COM A4, A9, B4, B9: V+ CC1:A5, D+ :A6 D- : A7, Blades/Input Cord: Not Applicable, Approvals: UKCA; Morocco; PSE; CAN ICES-3; RCM (pending); China RoHS; Level VI; CB 60601-1 (pending); LPS 62368; RoHS; Ukraine; VCCI; WEEE; Double Insulation; CCC (pending); FCC; cETLus 60601-1 3rd (pending); 230V CoC Tier 2; CB 60950 (pending); CB 62368; EAC;ccc;	
	Model No. GTM96183-36PD-USB1C	
	Part No./Ordering No. WR9QZ1800USBCFG2R6B	Rev A3

E=Output (輸出) 5.0V  3.0A 5.8V  3.0A 9.0V  3.0A 12.0V  3.0A 15.0V  2.4A 15.1V  2.38A 20.0V  1.8A F=GTF-7483-1
--

GlobTek, Inc. www.globtek.com 186 Veterans Drive, Northvale, NJ 07647 Tel. (201) 784-1000 Fax (201) 784-0111	Drawing Title: GTM96183-36PD-USB1C, USB Adaptive Power Source ICT/ITE/Medical Power supply, Efficiency Level: USA DOE Level VI / Eco-design Directive 2009/125/EC, (EU) 2019/1782, Case Color/Style: GlobTek Black, Wall Plug-in, USB Adaptive Power Supply AC Adaptor, Input Rating: 100-240V~, 50-60 Hz, Interchangeable Blades http://en.globtek.com/interchangeable-blades.php , Output Rating: 36W, 5.0V, 5.8V, 9.0V, 12.0V, 15.0V, 15.1V, 20.0VV@3.0A, 3.0A, 3.0A, 2.4A, 2.38A, 1.8AA, Output Configuration: N/A mm, N/A/ Cond, N/A, Type "C" USB "JACK", integral to power supply enclosure compliant with Directive (EU) 2022/2380 and 2014/53/EU Radio Equipment Directive (RED), Ferrite: None, N/A, GT Cord # C40133, Pin Out: A1, A12, B1, B12: COM A4, A9, B4, B9: V+ CC1:A5, D+ :A6 D- : A7, Blades/Input Cord: Not Applicable, Approvals: UKCA; Morocco; PSE; CAN ICES-3; RCM (pending); China RoHS; Level VI; CB 60601-1 (pending); LPS 62368; RoHS; Ukraine; VCCI; WEEE; Double Insulation; CCC (pending); FCC; cETLus 60601-1 3rd (pending); 230V CoC Tier 2; CB 60950 (pending); CB 62368; EAC;cco;	
	Model No. GTM96183-36PD-USB1C	
	Part No./Ordering No. WR9QZ1800USBCFG2R6B	Rev A3

AGENCY ONLINE DOCUMENTS	http://www.globtek.info/certs/GTM96183-PD/
CE EC-Declaration for Medical	Contact GlobTek for more information
CE EC-Declaration for Industrial/Commercial/ITE	http://globtek.force.com/models/ec_declaration_product?id=01t3a000004fwBQ&i=2
CE EC-Declaration for Household	Contact GlobTek for more information
UKCA-Declaration for Medical	Contact GlobTek for more information
UKCA-Declaration for Industrial/Commercial/ITE	http://globtek.force.com/models/ukca_declaration_product?id=01t3a000004fwBQ&i=2
UKCA-Declaration for Household	Contact GlobTek for more information
Morocco SDoC Declaration	https://globtek.secure.force.com/models/Morocco_SDoC_Declaration?id=a0O3a00000M3yqaEAB
RoHS/RoHS3 Declaration	https://www.globtek.com/pdf/rohs_cert/01t3a000004fwBQAAY
REACH Declaration	https://www.globtek.com/pdf/iso_certificates/REACH.pdf
Conflict Minerals Declaration	https://www.globtek.com/pdf/conflict-minerals.pdf
Prop 65 Statement	https://en.globtek.com/prop-65-statement.pdf
IPXY rating is based on 3rd party testing and customers should check suitability and test system level IPXY rating before ordering.	

Regulatory Certifications/Label Markings

Below follows a link to the latest regulatory certifications and marks for this specific product. National standards as well as certification schemes are constantly changing and so is the set of certification marks and symbols applicable to this product. Various standards, marks and symbols, and certificates are subject to change at any time without notice.

Additional standards or unique country certifications are available upon request. Please contact Globtek to request a quotation.

LATEST PRODUCT/MODEL CERTIFICATIONS: <https://www.globtek.com/datasheet/w70608>

AGENCY ONLINE DOCUMENTS <http://www.globtek.info/certs/GTM96183-PD/>



(F1) Class II / Double Insulated

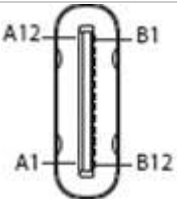

A1, A12, B1, B12: COM
A4, A9, B4, B9: V+
CC1:A5,
D+ :A6
D- : A7

[Mates with GlobTek USB Type C cables available at: <https://en.globtek.com/cordsets/usb-cables-cords-assemblies>](#)

<p>GlobTek, Inc. www.globtek.com 186 Veterans Drive, Northvale, NJ 07647 Tel. (201) 784-1000 Fax (201) 784-0111</p>	<p>Drawing Title: GTM96183-36PD-USB1C, USB Adaptive Power Source ICT/ITE/Medical Power supply, Efficiency Level: USA DOE Level VI / Eco-design Directive 2009/125/EC, (EU) 2019/1782, Case Color/Style: GlobTek Black, Wall Plug-in, USB Adaptive Power Supply AC Adaptor, Input Rating: 100-240V~, 50-60 Hz, Interchangeable Blades http://en.globtek.com/interchangeable-blades.php, Output Rating: 36W, 5.0V, 5.8V, 9.0V, 12.0V, 15.0V, 15.1V, 20.0VV@3.0A, 3.0A, 3.0A, 3.0A, 2.4A, 2.38A, 1.8AA, Output Configuration: N/A mm, N/A/ Cond, N/A, Type "C" USB "JACK", integral to power supply enclosure compliant with Directive (EU) 2022/2380 and 2014/53/EU Radio Equipment Directive (RED), Ferrite: None, N/A, GT Cord # C40133, Pin Out: A1, A12, B1, B12: COM A4, A9, B4, B9: V+ CC1:A5, D+ :A6 D- : A7, Blades/Input Cord: Not Applicable, Approvals: UKCA; Morocco; PSE; CAN ICES-3; RCM (pending); China RoHS; Level VI; CB 60601-1 (pending); LPS 62368; RoHS; Ukraine; VCCI; WEEE; Double Insulation; CCC (pending); FCC; cETLus 60601-1 3rd (pending); 230V CoC Tier 2; CB 60950 (pending); CB 62368; EAC;ccc;</p>	
	<p>Model No. GTM96183-36PD-USB1C</p>	
	<p>Part No./Ordering No. WR9QZ1800USBCFG2R6B</p>	<p>Rev A3</p>

PACKAGING

Packing Spec P/N	Standard, Cellular packaging
Box Qty	120
Gift Box Size (mm)	Egg Crate
Gift Box Color	None
Master Carton Size (mm)	380 x 380 x 250
Master Carton Cubic Volume (m³)	0.04
Master GW (Kg)	10.0 kg
BLADES INCLUDED	N/A: Not Applicable
BLADE/CORD INSTALLED	N/A: Not Applicable
USER MANUAL*	
USER MANUAL WEB LINK	

* This specification sheet is considered the user manual for all applications. It is expected that the buyer of this product will use it to formulate their own user manual for their end product and a user manual specifically for the power adapter is not usually required. If a user manual is not specifically listed above then none will be provided with this unit.

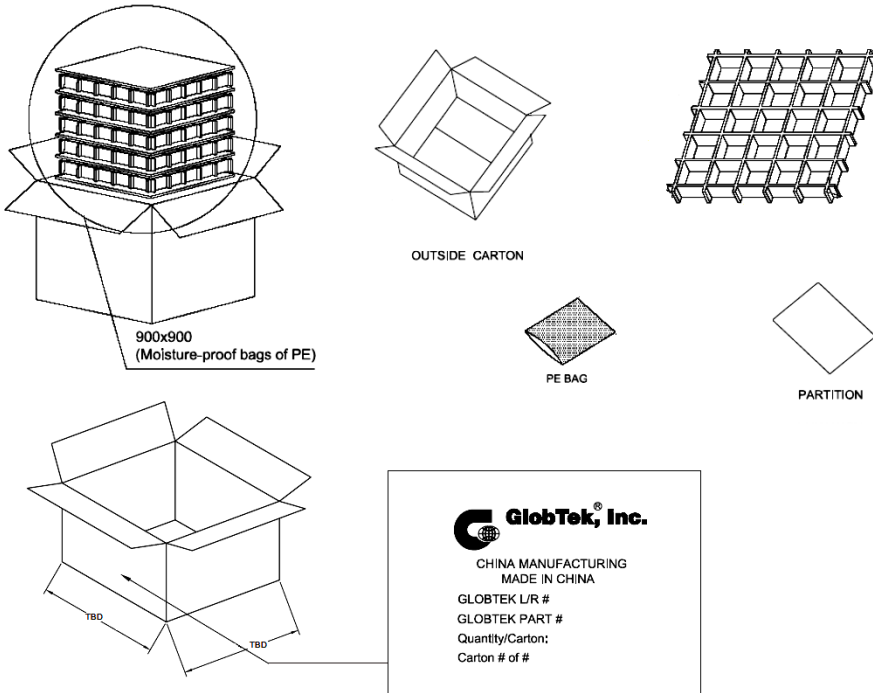

PROPRIETARY INFORMATION

GloTek, Inc. www.globtek.com 186 Veterans Drive, Northvale, NJ 07647 Tel. (201) 784-1000 Fax (201) 784-0111	Drawing Title: GTM96183-36PD-USB1C, USB Adaptive Power Source ICT/ITE/Medical Power supply, Efficiency Level: USA DOE Level VI / Eco-design Directive 2009/125/EC, (EU) 2019/1782, Case Color/Style: GlobTek Black, Wall Plug-in, USB Adaptive Power Supply AC Adaptor, Input Rating: 100-240V~, 50-60 Hz, Interchangeable Blades http://en.globtek.com/interchangeable-blades.php , Output Rating: 36W, 5.0V, 5.8V, 9.0V, 12.0V, 15.0V, 15.1V, 20.0VV@3.0A, 3.0A, 3.0A, 3.0A, 2.4A, 2.38A, 1.8AA, Output Configuration: N/A mm, N/A/ Cond, N/A, Type "C" USB "JACK", integral to power supply enclosure compliant with Directive (EU) 2022/2380 and 2014/53/EU Radio Equipment Directive (RED), Ferrite: None, N/A, GT Cord # C40133, Pin Out: A1, A12, B1, B12: COM A4, A9, B4, B9: V+ CC1:A5, D+ :A6 D- : A7, Blades/Input Cord: Not Applicable, Approvals: UKCA; Morocco; PSE; CAN ICES-3; RCM (pending); China RoHS; Level VI; CB 60601-1 (pending); LPS 62368; RoHS; Ukraine; VCCI; WEEE; Double Insulation; CCC (pending); FCC; cETLus 60601-1 3rd (pending); 230V CoC Tier 2; CB 60950 (pending); CB 62368; EAC;cco;	
	Model No. GTM96183-36PD-USB1C	
	Part No./Ordering No. WR9QZ1800USBCFG2R6B	Rev A3

INSTRUCTIONS TO THE OEM SYSTEMS ENGINEER

It is the responsibility of the OEM systems engineer to provide the end system user instructions and warnings for the use of this product in the end system.

If an input cord is required for this product, AC Mains voltage should be provided to the power supply by a power supply cord approved to the national standards of the country in which it will be used.

This product is not designed to be repaired. No serviceable parts inside. A blown internal fuse is an indication of catastrophic failure of circuit component(s). If a Failure Analysis is required for a failed power supply/battery charger, please return the damaged unit to GlobTek for an accurate determination of the root cause of the failure.

EMC Compliance of the complete OEM product, including the GlobTek power supply/battery charger needs to be verified by the OEM systems engineer.

INSTRUCTION SHEET

Q Blades Instruction Sheet (not required to be packaged with product)

Insertion Instructions: <http://www.globtek.com/pdf/Instructions-Interchangeable-Blades.pdf>

This manual is Provided to customer within the product specification - it is the responsibility of the OEM/customer to provide the end system user instructions + warnings for the use of this product in the end system. By accepting this specification the customer/OEM Agrees to these terms.

USER MANUAL FOR Q-BLADE SERIES SWITCHING POWER SUPPLIES

Manual del Usuario. Fuentes de Alimentación Series Q-Blade

WARNING! RISK OF FIRE! SHOCK HAZARD!: To prevent electric shock, do not remove the cover. No user-serviceable parts inside. This unit contains hazardous voltages and should only be opened by a trained and qualified technician. Do not use if bent, cracked, modified or compromised. To avoid the possibility of electric shock, disconnect electric power to the product before connecting or disconnecting.

Advertencia! Riesgo de Fuego! Peligro de Choque eléctrico! No contiene dentro componentes servibles para el usuario. Desconecte el cable de alimentación antes de quitar la cubierta.

INDOOR USE ONLY!

Únicamente para uso en el interior.

POWER SUPPLY BLADE/CORD: AC Mains voltage should be provided to the power supply by a power supply cords approved to the national standards in which it will be used. Please use the below table as a guideline for Suitable Power cords.

GloTek, Inc. www.globtek.com 186 Veterans Drive, Northvale, NJ 07647 Tel. (201) 784-1000 Fax (201) 784-0111	Drawing Title: GTM96183-36PD-USB1C, USB Adaptive Power Source ICT/ITE/Medical Power supply, Efficiency Level: USA DOE Level VI / Eco-design Directive 2009/125/EC, (EU) 2019/1782, Case Color/Style: GlobTek Black, Wall Plug-in, USB Adaptive Power Supply AC Adaptor, Input Rating: 100-240V~, 50-60 Hz, Interchangeable Blades http://en.globtek.com/interchangeable-blades.php , Output Rating: 36W, 5.0V, 5.8V, 9.0V, 12.0V, 15.0V, 15.1V, 20.0VV@3.0A, 3.0A, 3.0A, 3.0A, 2.4A, 2.38A, 1.8AA, Output Configuration: N/A mm, N/A/ Cond, N/A, Type "C" USB "JACK", integral to power supply enclosure compliant with Directive (EU) 2022/2380 and 2014/53/EU Radio Equipment Directive (RED), Ferrite: None, N/A, GT Cord # C40133, Pin Out: A1, A12, B1, B12: COM A4, A9, B4, B9: V+ CC1:A5, D+ :A6 D- : A7, Blades/Input Cord: Not Applicable, Approvals: UKCA; Morocco; PSE; CAN ICES-3; RCM (pending); China RoHS; Level VI; CB 60601-1 (pending); LPS 62368; RoHS; Ukraine; VCCI; WEEE; Double Insulation; CCC (pending); FCC; cETLus 60601-1 3rd (pending); 230V CoC Tier 2; CB 60950 (pending); CB 62368; EAC;ccc;	
	Model No. GTM96183-36PD-USB1C	
	Part No./Ordering No. WR9QZ1800USBCFG2R6B	Rev A3

CABLE DE ALIMENTACIÓN: El voltaje de la CA debe proporcionarse a la fuente de alimentación mediante los cables de alimentación aprobados conforme a las normas nacionales según las cuales será utilizada. Utilice por favor la tabla mencionada aquí abajo como guía para los cables eléctricos adecuados.

1. Class II model NEMA 1-15P AC power plug with 2 prongs, Q-NA(R)
2. Australian AS 3112 configuration: SAA 2 pins Class II, Q-SAA(R)
3. UK BS 1363 configuration: UK 2 pins Class II, Q-UK(R)
4. European CEE 7/16 configuration: Europlug 2 PINS, Class II, Q-EU(R)
5. Korean KS C8305 configuration: Q-KR(R)
6. Argentina IRAM 2073 configuration: 2 pins, Class II Q-AR(R)
7. China GR 2099 configuration: 2 pins, Class II Q-CN(R)
8. India configuration: 2 pins, Class II, Q-IN(R)
9. IEC320/C18 Inlet

FUSING: Internal fuse for Line is provided in the power supply. A blown internal fuse is an indication of catastrophic failure of circuit component(s). Repair must be performed by GloTek, Inc. authorized personnel. Fuses must be replaced with same type and ratings per GloTek internal documentation.

FUSIBLES: La fuente de alimentación provee un fusible interno para la línea. Un fusible interno quemado es un indicador de una falla catastrófica de los componentes del circuito. La reparación debe ser hecha por personal autorizado de GloTek, Inc. Los fusibles se deben reemplazar por los mismos tipos y rangos que la documentación interna de GloTek mencione.

GlobTek, Inc.
 www.globtek.com
 186 Veterans Drive,
 Northvale, NJ 07647
 Tel. (201) 784-1000
 Fax (201) 784-0111

Drawing Title: GTM96183-36PD-USB1C, USB Adaptive Power Source ICT/ITE/Medical Power supply, Efficiency Level: USA DOE Level VI / Eco-design Directive 2009/125/EC, (EU) 2019/1782, Case Color/Style: GlobTek Black, Wall Plug-in, USB Adaptive Power Supply AC Adaptor, Input Rating: 100-240V~, 50-60 Hz, Interchangeable Blades <http://en.globtek.com/interchangeable-blades.php>, Output Rating: 36W, 5.0V, 5.8V, 9.0V, 12.0V, 15.0V, 15.1V, 20.0VV@3.0A, 3.0A, 3.0A, 3.0A, 2.4A, 2.38A, 1.8AA, Output Configuration: N/A mm, N/A/ Cond, N/A, Type "C" USB "JACK", integral to power supply enclosure compliant with Directive (EU) 2022/2380 and 2014/53/EU Radio Equipment Directive (RED), Ferrite: None, N/A, GT Cord # C40133, Pin Out: A1, A12, B1, B12: COM A4, A9, B4, B9: V+ CC1:A5, D+ :A6 D- : A7, Blades/Input Cord: Not Applicable, Approvals: UKCA; Morocco; PSE; CAN ICES-3; RCM (pending); China RoHS; Level VI; CB 60601-1 (pending); LPS 62368; RoHS; Ukraine; VCCI; WEEE; Double Insulation; CCC (pending); FCC; cETLus 60601-1 3rd (pending); 230V CoC Tier 2; CB 60950 (pending); CB 62368; EAC;ccc;

Model No. GTM96183-36PD-USB1C

Part No./Ordering No. WR9QZ1800USBCFG2R6B

Rev A3

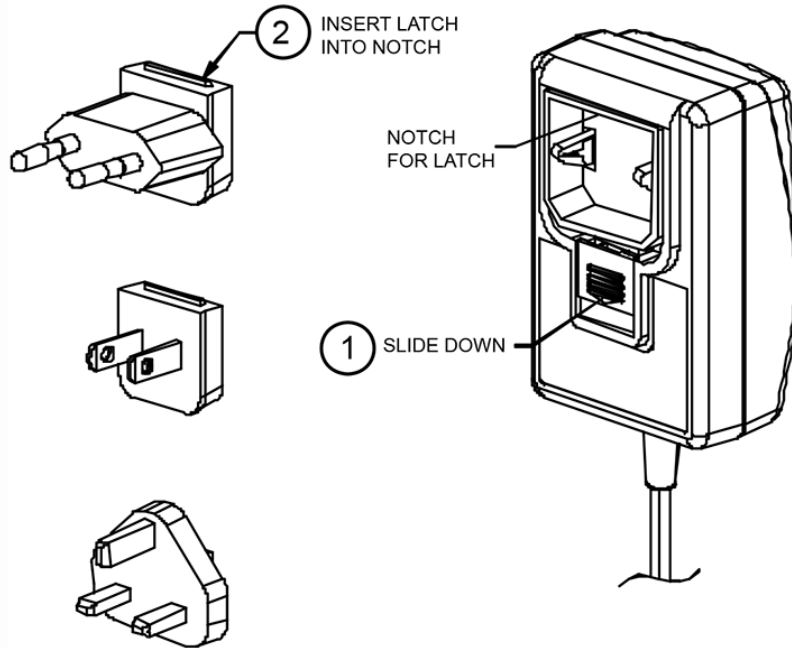

This symbol on an instrument indicates that the user should refer to the operating instructions located in the manual.

Please note:

The blades shown above are for representation of the installation process and do not indicate which AC blades are included with this power supply. Please reference the specifications "Power Supply Information" (page 2) and "Input Configuration" (page 6) for information regarding the actual blade included with this power supply, if any.

<p>GlobTek, Inc. www.globtek.com 186 Veterans Drive, Northvale, NJ 07647 Tel. (201) 784-1000 Fax (201) 784-0111</p>	<p>Drawing Title: GTM96183-36PD-USB1C, USB Adaptive Power Source ICT/ITE/Medical Power supply, Efficiency Level: USA DOE Level VI / Eco-design Directive 2009/125/EC, (EU) 2019/1782, Case Color/Style: GlobTek Black, Wall Plug-in, USB Adaptive Power Supply AC Adaptor, Input Rating: 100-240V~, 50-60 Hz, Interchangeable Blades http://en.globtek.com/interchangeable-blades.php, Output Rating: 36W, 5.0V, 5.8V, 9.0V, 12.0V, 15.0V, 15.1V, 20.0VV@3.0A, 3.0A, 3.0A, 3.0A, 2.4A, 2.38A, 1.8AA, Output Configuration: N/A mm, N/A/ Cond, N/A, Type "C" USB "JACK", integral to power supply enclosure compliant with Directive (EU) 2022/2380 and 2014/53/EU Radio Equipment Directive (RED), Ferrite: None, N/A, GT Cord # C40133, Pin Out: A1, A12, B1, B12: COM A4, A9, B4, B9: V+ CC1:A5, D+ :A6 D- : A7, Blades/Input Cord: Not Applicable, Approvals: UKCA; Morocco; PSE; CAN ICES-3; RCM (pending); China RoHS; Level VI; CB 60601-1 (pending); LPS 62368; RoHS; Ukraine; VCCI; WEEE; Double Insulation; CCC (pending); FCC; cETLus 60601-1 3rd (pending); 230V CoC Tier 2; CB 60950 (pending); CB 62368; EAC;ccc;</p>	
	<p>Model No. GTM96183-36PD-USB1C</p>	
	<p>Part No./Ordering No. WR9QZ1800USBCFG2R6B</p>	<p>Rev A3</p>

