

ISOMETRIC VIEW

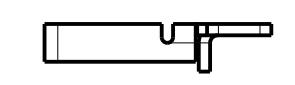

This drawing is the property of BANNER ENGINEERING CORP. Any use or reproduction, in any form, without prior written permission of Banner is prohibited. © 2015 Banner Engineering Corp.

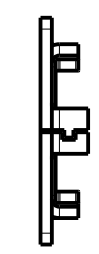
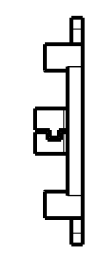
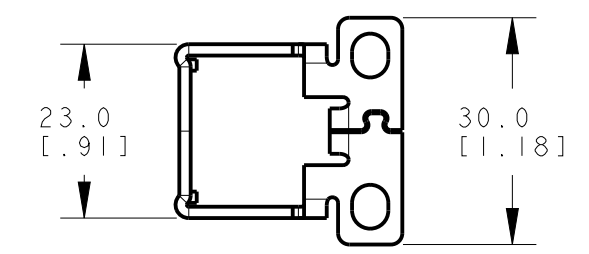
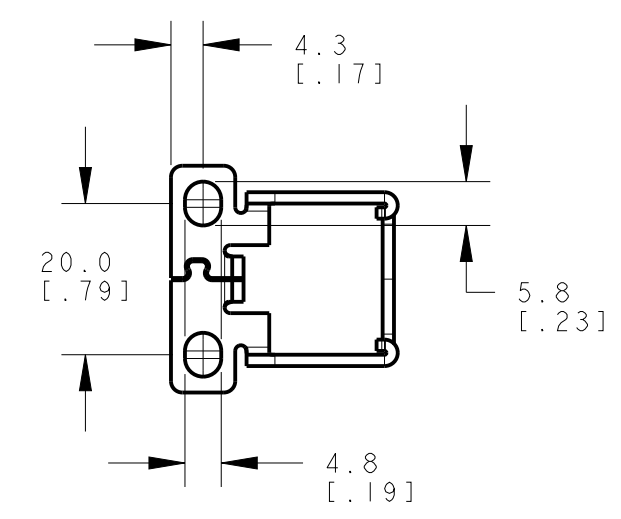
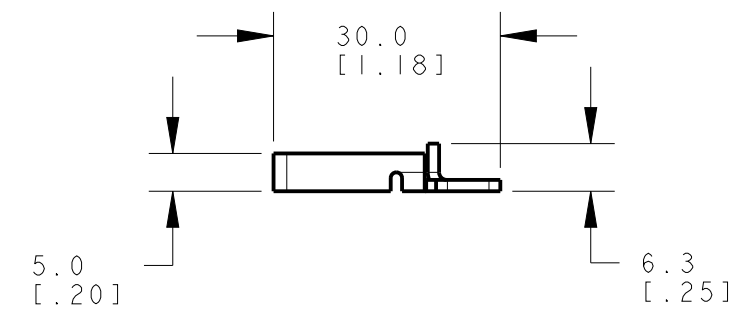

BANNER ENGINEERING CORP.
www.bannerengineering.com

THIRD ANGLE PROJECTION

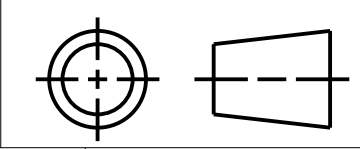

TITLE
SI-QS-SSA-2 ACCUATOR

SIZE B	DRAWING NO. 212882	REV. A
SCALE 1:1	SHEET 1 OF 1	

NOTES:
1. ALL DIMENSIONS ARE MILLIMETERS [INCHES] UNLESS OTHERWISE NOTED.
2. REFER TO "www.bannerengineering.com" FOR ADDITIONAL DATA AND SPECIFICATIONS.

CREO