

4G/ LTE Magnetic Mount Antenna



AEACAD097015-S698

97 x Ø 15 mm

RoHS/RoHS II Compliant

MSL - 1

FEATURES

- Operates in 700-2700 MHz
- Linear polarization
- High gain of 5 dBi
- Omni-directional pattern
- VSWR 2.5

APPLICATIONS

- 4G/LTE radios
- Gateways
- Set-Top boxes
- Security
- IoT
- M2M
- Transportation
- Smart agriculture

Electrical Characteristics

Parameters	Min.	Typ.	Max	Units	Note
Frequency Range		700 ~ 2700		MHz	
VSWR			2.5		
Polarization Model	Linear				
Impedance		50		Ω	
Gain		5.0		dBi	Zenith

Mechanical Characteristics

Parameters	Note
Connector	SMA
Cable Type	RG58
Cable Length	3M
Mounting	Magnetic
Dimensions	97 x Φ 62 mm



5101 Hidden Creek Ln Spicewood TX 78669
Phone: 512-371-6159 | Fax: 512-351-8858
For terms and conditions of sales, please visit:
www.abracon.com

REVISED: 08.15.2018

ABRACON IS
ISO9001-2015
CERTIFIED

4G/ LTE Magnetic Mount Antenna



AEACAD097015-S698

97 x Ø 15 mm

RoHS/RoHS II Compliant

MSL - 1

Dimensions

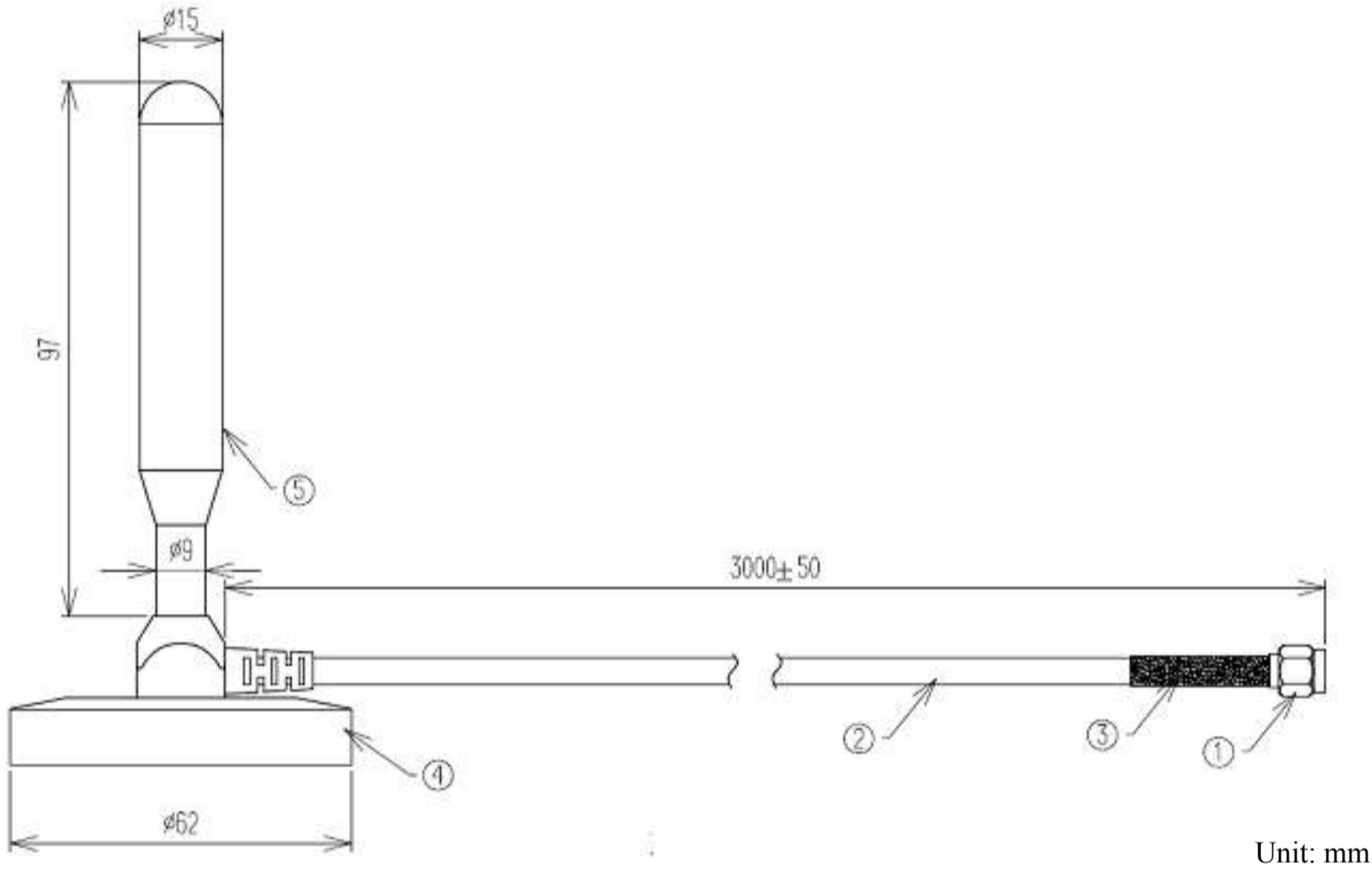

Unit: mm

Product Image



4G/ LTE Magnetic Mount Antenna



AEACAD097015-S698

97 x Ø 15 mm

RoHS/RoHS II Compliant

MSL - 1

VSWR

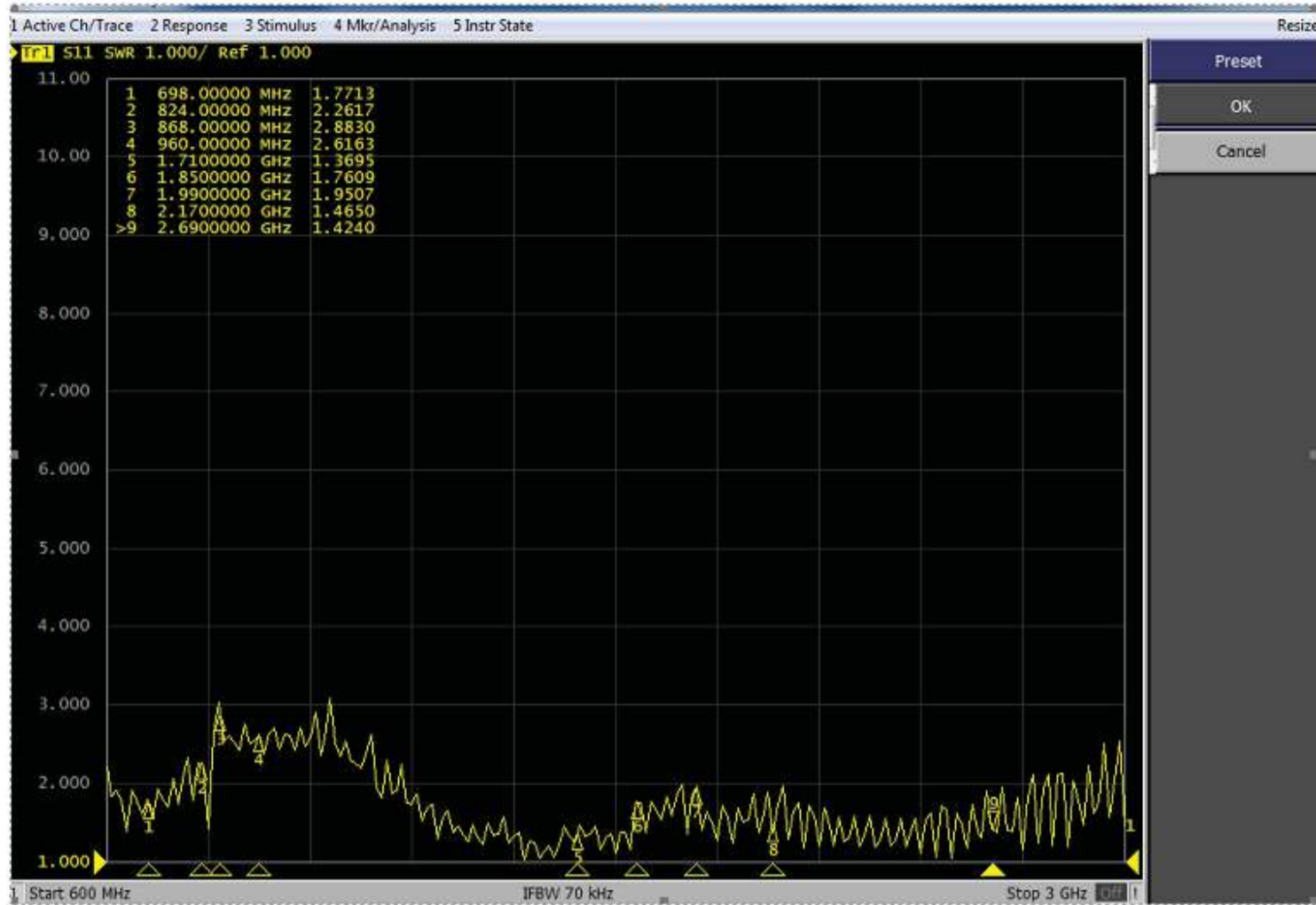

Gain and Efficiency

Frequency(MHz)	Efficiency (%)	Gain (dBi)
700	0.65	4.87
824	0.62	3.08
868	0.61	3.09
960	0.60	2.56
1710	0.53	2.85
1850	0.59	2.92
1990	0.52	1.81
2170	0.57	2.46
2690	0.58	2.66



5101 Hidden Creek Ln Spicewood TX 78669
 Phone: 512-371-6159 | Fax: 512-351-8858
 For terms and conditions of sales, please visit:
www.abracon.com

REVISED: 08.15.2018

ABRACON IS
 ISO9001-2015
 CERTIFIED

4G/ LTE Magnetic Mount Antenna

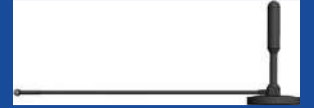

AEACAD097015-S698

97 x Ø 15 mm

RoHS/RoHS II Compliant

MSL - 1

Radiation Pattern

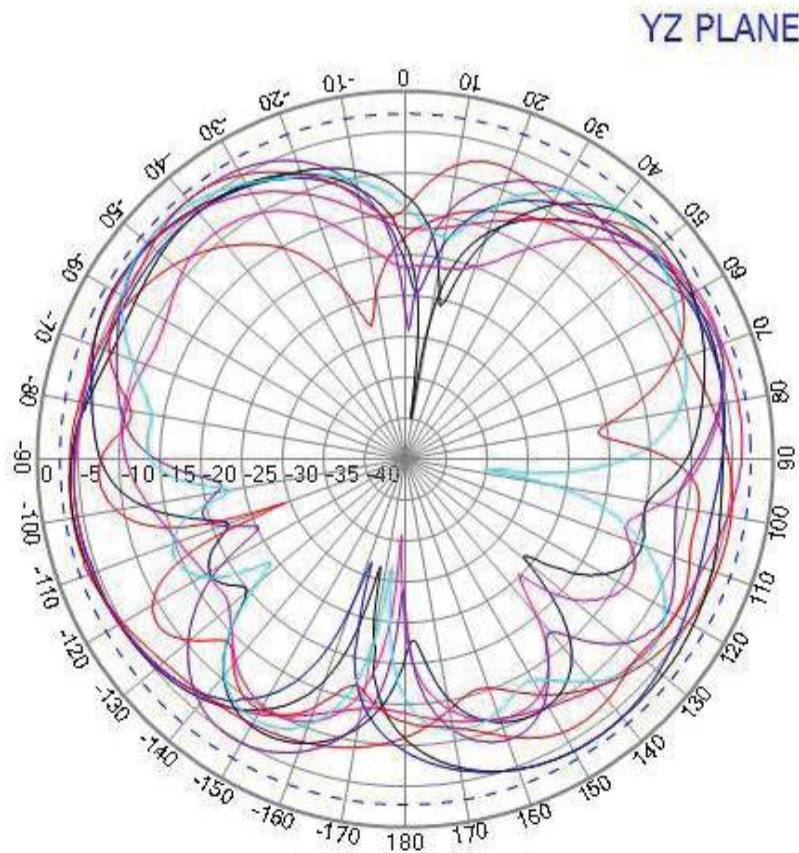
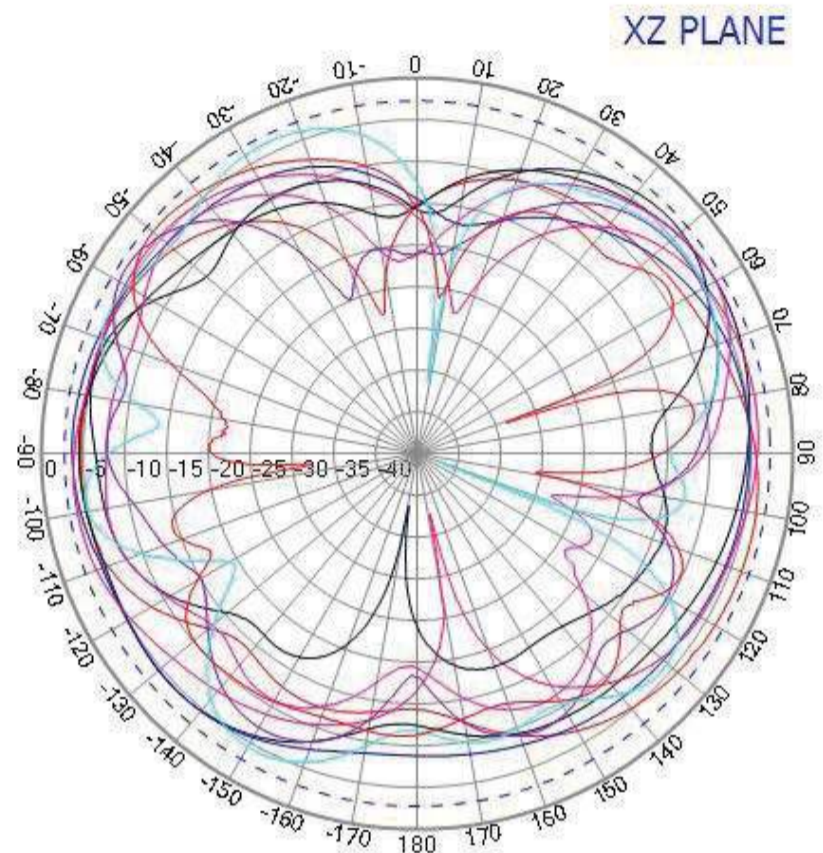
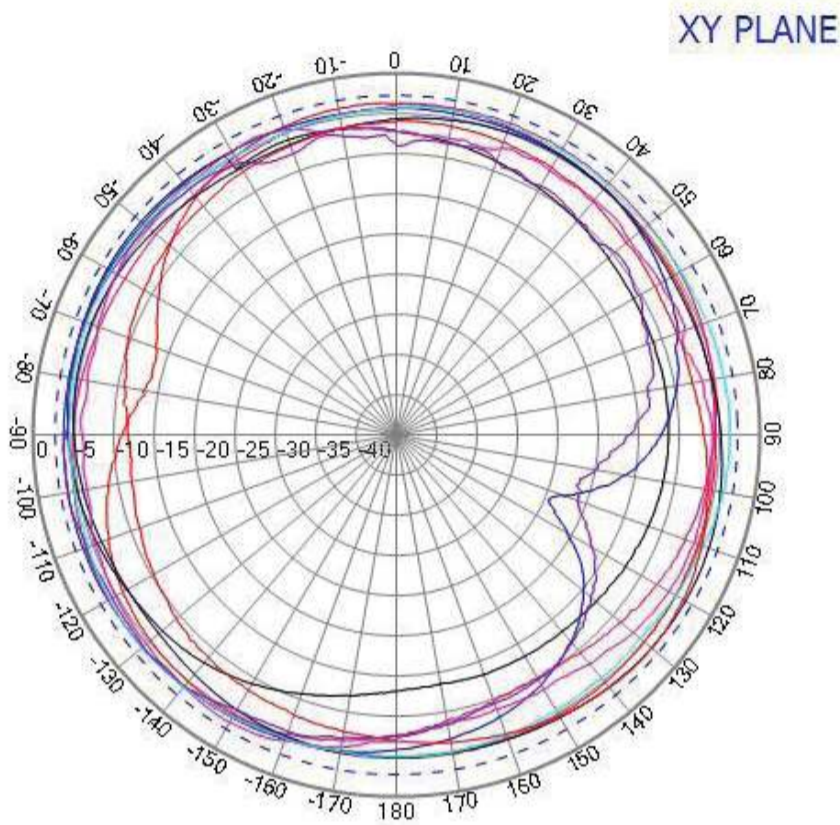

5101 Hidden Creek Ln Spicewood TX 78669
Phone: 512-371-6159 | Fax: 512-351-8858
For terms and conditions of sales, please visit:
www.abracon.com

REVISED: 08.15.2018

ABRACON IS
ISO9001-2015
CERTIFIED

4G/ LTE Magnetic Mount Antenna



AEACAD097015-S698

97 x Ø 15 mm

RoHS/RoHS II Compliant

MSL - 1

Radiation Pattern

3D Radiation Patterns

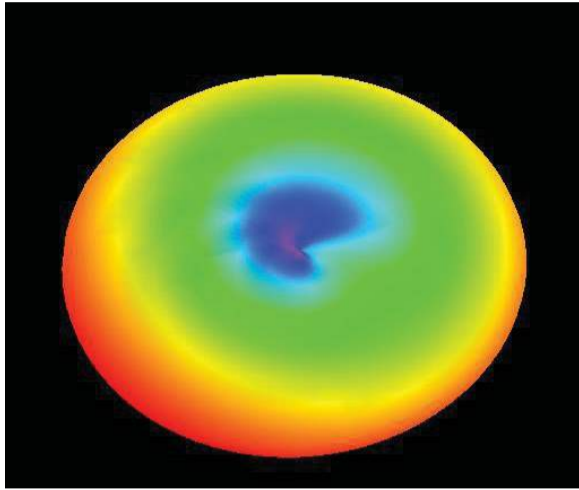

698 MHz

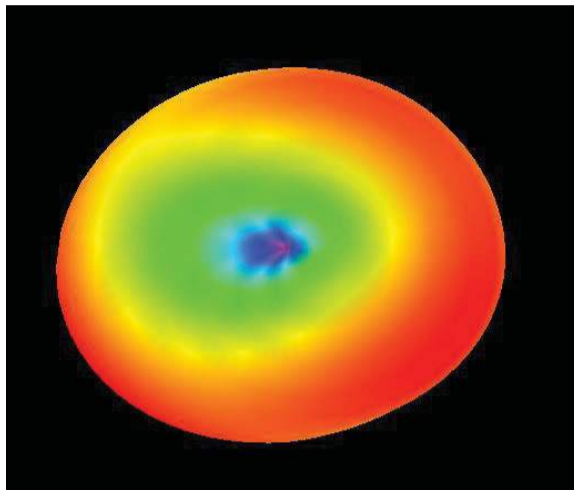

824 MHz

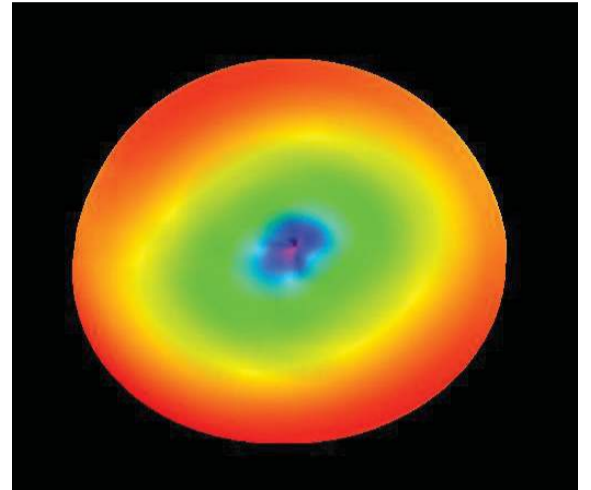

868 MHz

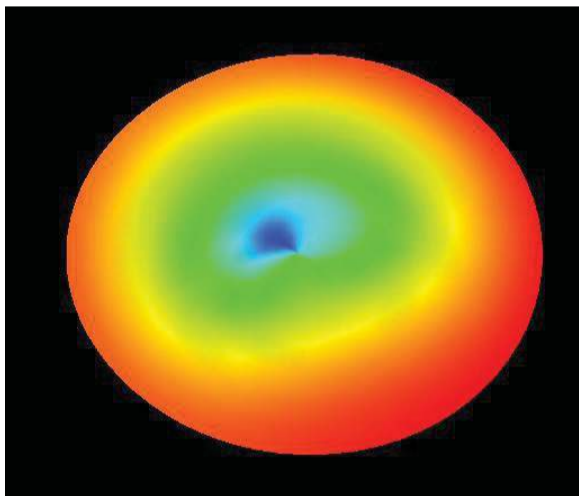

960 MHz

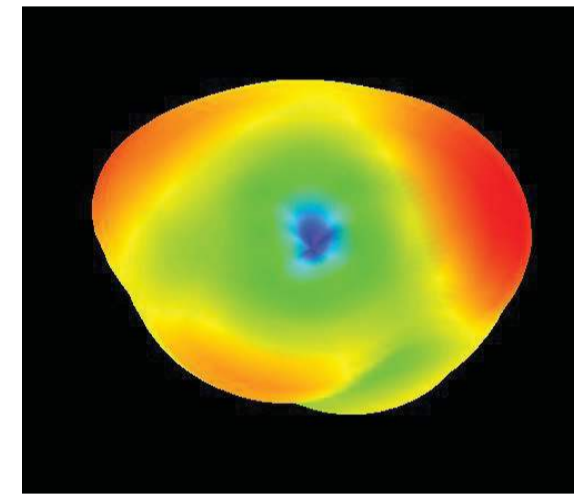

1710 MHz

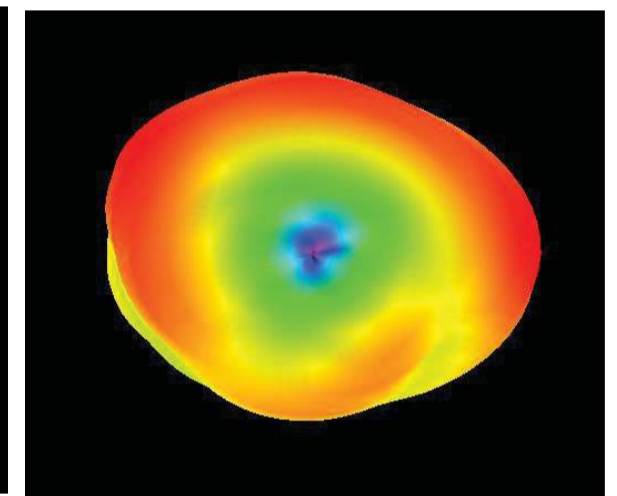

1850 MHz

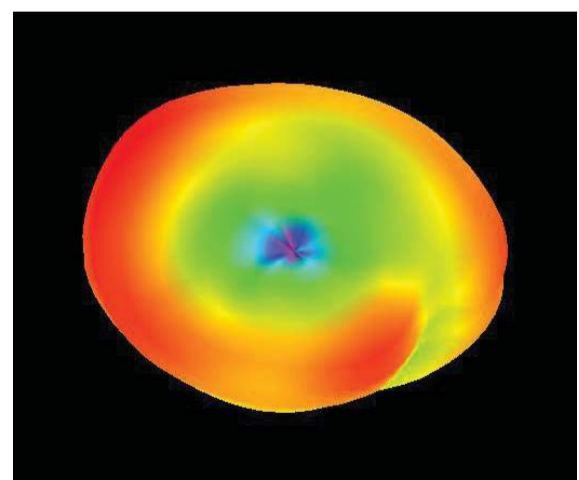

1900 MHz

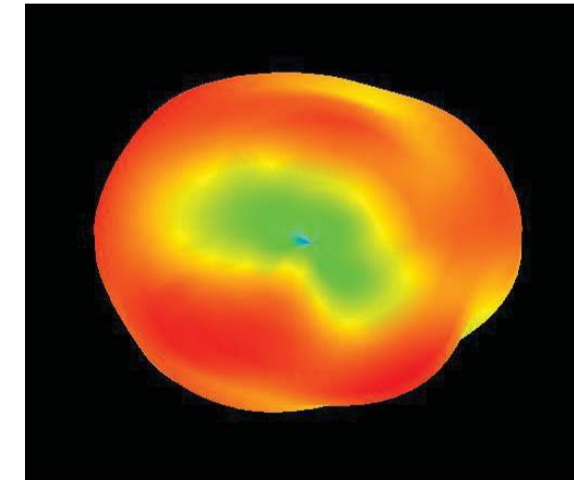

2170 MHz

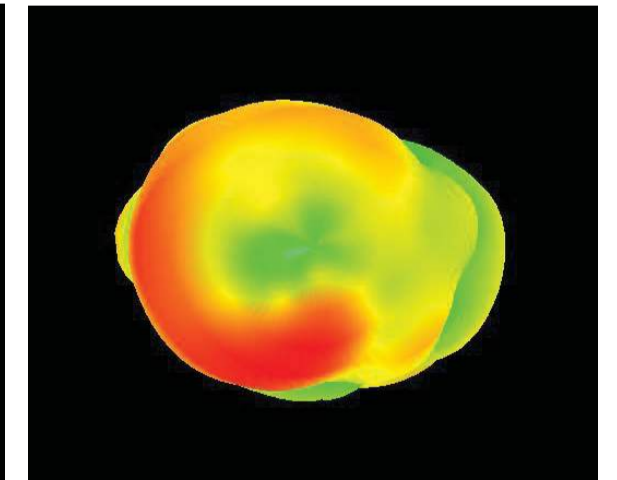

2690 MHz



5101 Hidden Creek Ln Spicewood TX 78669
Phone: 512-371-6159 | Fax: 512-351-8858
For terms and conditions of sales, please visit:
www.abracon.com

REVISED: 08.15.2018

ABRACON IS
ISO9001-2015
CERTIFIED

4G/ LTE Magnetic Mount Antenna



AEACAD097015-S698

97 x Ø 15 mm

RoHS/RoHS II Compliant

MSL - 1

Packaging

Each 35 x 35 x 30cm size carton includes 50 pcs antenna, weighs 15 kg



5101 Hidden Creek Ln Spicewood TX 78669
Phone: 512-371-6159 | Fax: 512-351-8858
For terms and conditions of sales, please visit:
www.abracon.com

REVISED: 08.15.2018

ABRACON IS
ISO9001-2015
CERTIFIED