

IGBT Module

Sixpack

Short Circuit SOA Capability
Square RBSOA

$I_{C25} = 52 \text{ A}$
 $V_{CES} = 1200 \text{ V}$
 $V_{CE(sat) \text{ typ.}} = 1.9 \text{ V}$

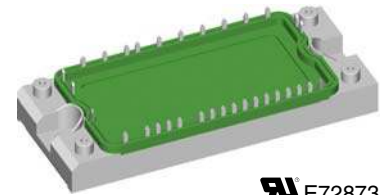
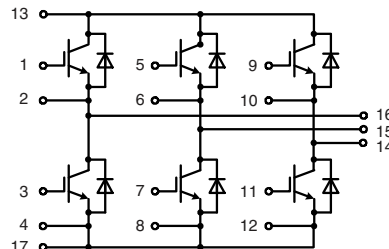

IXYS E72873

See outline drawing for pin arrangement

IGBTs		
Symbol	Conditions	Maximum Ratings
V_{CES}	$T_{VJ} = 25^{\circ}\text{C to } 150^{\circ}\text{C}$	1200 V
V_{GES}		$\pm 20 \text{ V}$
I_{C25}	$T_C = 25^{\circ}\text{C}$	52 A
I_{C80}	$T_C = 80^{\circ}\text{C}$	36 A
I_{CM}	$V_{GE} = \pm 15 \text{ V}; R_G = 39 \Omega; T_{VJ} = 125^{\circ}\text{C}$	70 A
V_{CEK}	RBSOA; clamped inductive load; $L = 100 \mu\text{H}$	V_{CES}
t_{SC}	$V_{CE} = 900 \text{ V}; V_{GE} = \pm 15 \text{ V}; R_G = 39 \Omega; T_{VJ} = 125^{\circ}\text{C}$ SCSOA; non-repetitive	10 μs
P_{tot}	$T_C = 25^{\circ}\text{C}$	225 W

Features

- NPT³ IGBTs
 - low saturation voltage
 - positive temperature coefficient for easy paralleling
 - fast switching
 - short tail current for optimized performance also in resonant circuits
- HiPerFREDTM diode:
 - fast reverse recovery
 - low operating forward voltage
 - low leakage current
- Industry Standard Package
 - solderable pins for PCB mounting
 - isolated copper base plate

Typical Applications

- AC drives
- power supplies with power factor correction

Symbol	Conditions	Characteristic Values ($T_{VJ} = 25^{\circ}\text{C}$, unless otherwise specified)		
		min.	typ.	max.
$V_{CE(sat)}$	$I_C = 25 \text{ A}; V_{GE} = 15 \text{ V}; T_{VJ} = 25^{\circ}\text{C}$ $T_{VJ} = 125^{\circ}\text{C}$	1.9	2.4	V
$V_{GE(th)}$	$I_C = 1 \text{ mA}; V_{GE} = V_{CE}$	4.5		6.5 V
I_{CES}	$V_{CE} = V_{CES}; V_{GE} = 0 \text{ V}; T_{VJ} = 25^{\circ}\text{C}$ $T_{VJ} = 125^{\circ}\text{C}$	0.4		0.4 mA
I_{GES}	$V_{CE} = 0 \text{ V}; V_{GE} = \pm 20 \text{ V}$			200 nA
$t_{d(on)}$	Inductive load, $T_{VJ} = 125^{\circ}\text{C}$ $V_{CE} = 600 \text{ V}; I_C = 25 \text{ A}$ $V_{GE} = \pm 15 \text{ V}; R_G = 39 \Omega$		80	ns
t_r			50	ns
$t_{d(off)}$			440	ns
t_f			50	ns
E_{on}			3.8	mJ
E_{off}		2.0	mJ	
C_{ies}	$V_{CE} = 25 \text{ V}; V_{GE} = 0 \text{ V}; f = 1 \text{ MHz}$		2	nF
Q_{Gon}	$V_{CE} = 600 \text{ V}; V_{GE} = 15 \text{ V}; I_C = 35 \text{ A}$		150	nC
R_{thJC}	(per IGBT)			0.55 K/W

IXYS reserves the right to change limits, test conditions and dimensions.

Maximum Ratings

Symbol	Conditions	Maximum Ratings	
I_{F25}	$T_C = 25^\circ\text{C}$	50	A
I_{F80}	$T_C = 80^\circ\text{C}$	33	A

Symbol	Conditions	Characteristic Values		
		min.	typ.	max.
V_F	$I_F = 25\text{ A}; V_{GE} = 0\text{ V}; T_{VJ} = 25^\circ\text{C}$ $T_{VJ} = 125^\circ\text{C}$	2.3	2.7	V
		1.7		V
I_{RM} t_{rr} $E_{rec(off)}$	$I_F = 30\text{ A}; di_F/dt = -1100\text{ A}/\mu\text{s}; T_{VJ} = 125^\circ\text{C}$ $V_R = 600\text{ V}; V_{GE} = 0\text{ V}$	51		A
		180		ns
		1.8		mJ
R_{thJC}	(per diode)			1.19 K/W

Module

Symbol	Conditions	Maximum Ratings	
T_{VJ}		-40...+150	$^\circ\text{C}$
T_{stg}		-40...+125	$^\circ\text{C}$
V_{ISOL}	$I_{ISOL} \leq 1\text{ mA}; 50/60\text{ Hz}$	2500	V~
M_d	Mounting torque (M5)	2.7 - 3.3	Nm

Symbol	Conditions	Characteristic Values		
		min.	typ.	max.
$R_{pin-chip}$			5	m Ω
d_s	Creepage distance on surface	6		mm
d_A	Strike distance in air	6		mm
R_{thCH}	with heatsink compound		0.02	K/W
Weight			180	g

Equivalent Circuits for Simulation

Conduction

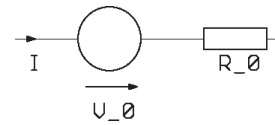

IGBT (typ. at $V_{GE} = 15\text{ V}; T_J = 125^\circ\text{C}$)
 $V_0 = 0.95\text{ V}; R_0 = 48\text{ m}\Omega$

Free Wheeling Diode (typ. at $T_J = 125^\circ\text{C}$)
 $V_0 = 1.3\text{ V}; R_0 = 16.0\text{ m}\Omega$

Thermal Response

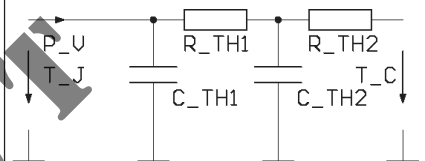

IGBT (typ.)
 $C_{th1} = 0.129\text{ J/K}; R_{th1} = 0.415\text{ K/W}$
 $C_{th2} = 1.279\text{ J/K}; R_{th2} = 0.135\text{ K/W}$

Free Wheeling Diode (typ.)
 $C_{th1} = 0.069\text{ J/K}; R_{th1} = 0.956\text{ K/W}$
 $C_{th2} = 0.847\text{ J/K}; R_{th2} = 0.234\text{ K/W}$

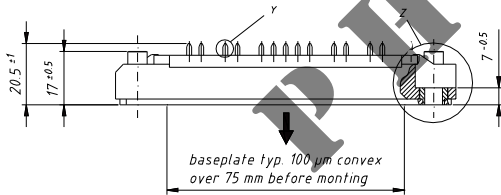

Dimensions in mm (1 mm = 0.0394")

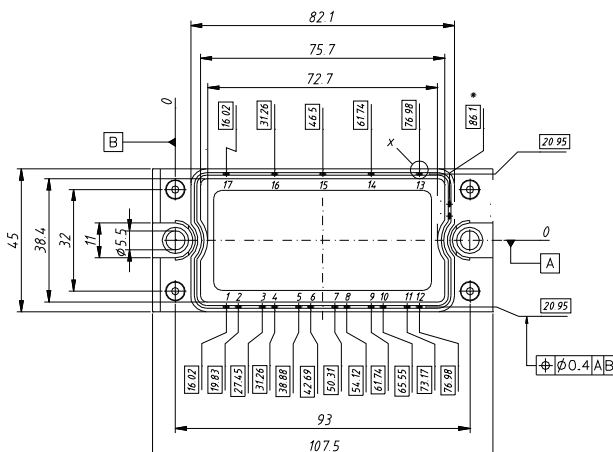

Detail X

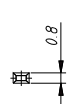

Detail Y

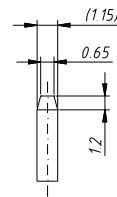

Detail Z

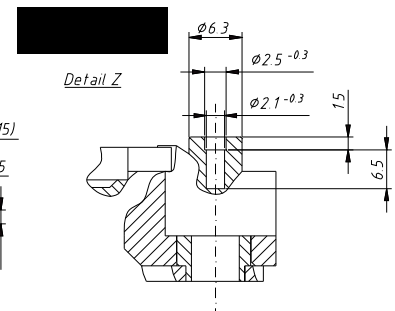

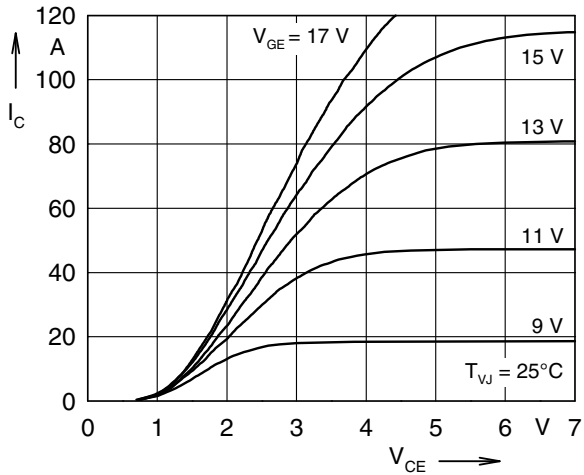

Fig. 1 Typ. output characteristics

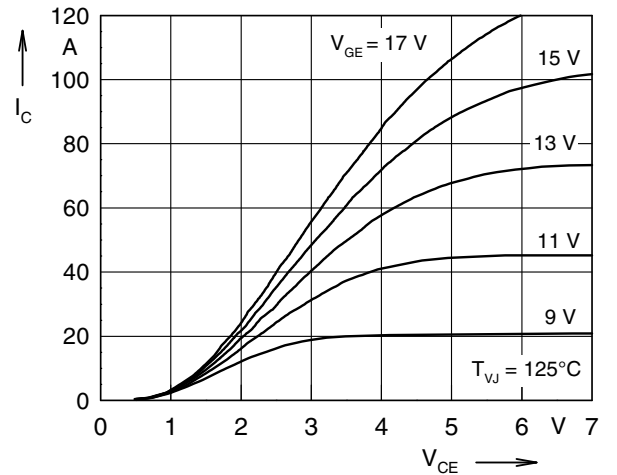

Fig. 2 Typ. output characteristics

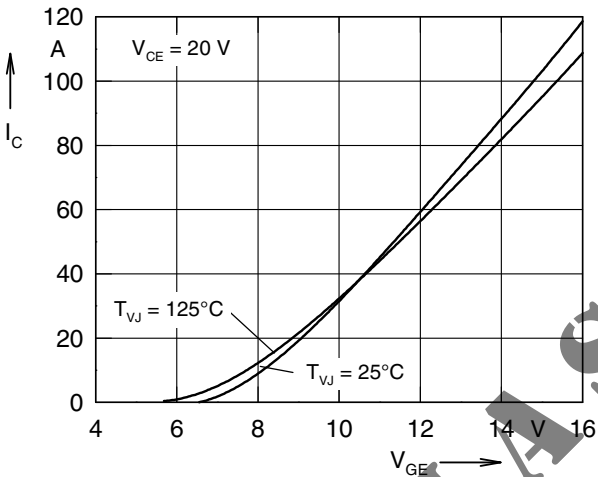

Fig. 3 Typ. transfer characteristics

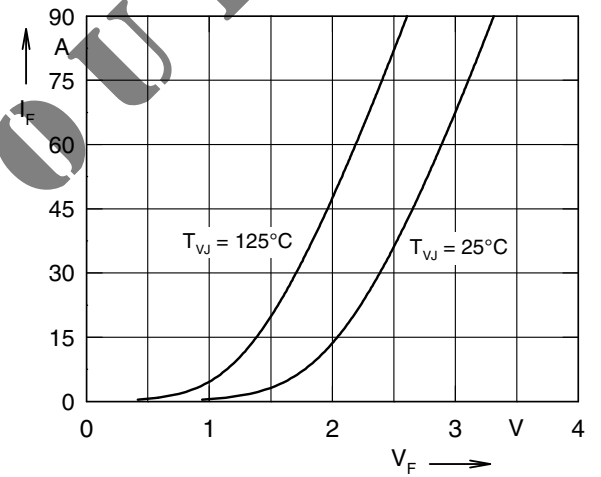

Fig. 4 Typ. forward characteristics of free wheeling diode

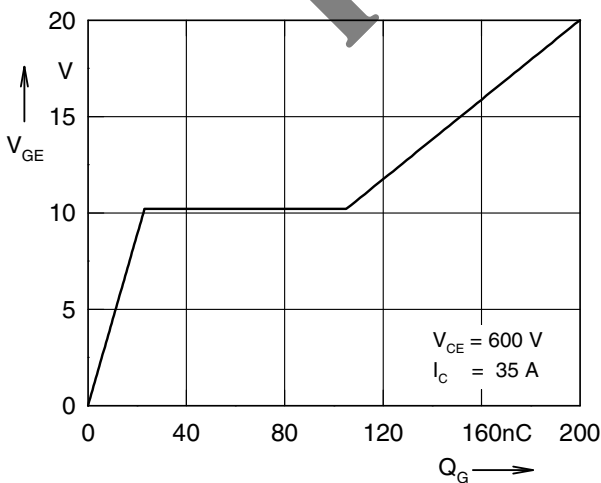

Fig. 5 Typ. turn on gate charge

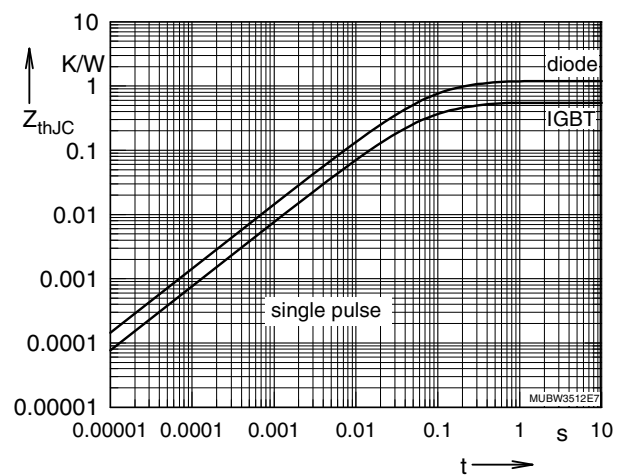

Fig. 6 Typ. transient thermal impedance

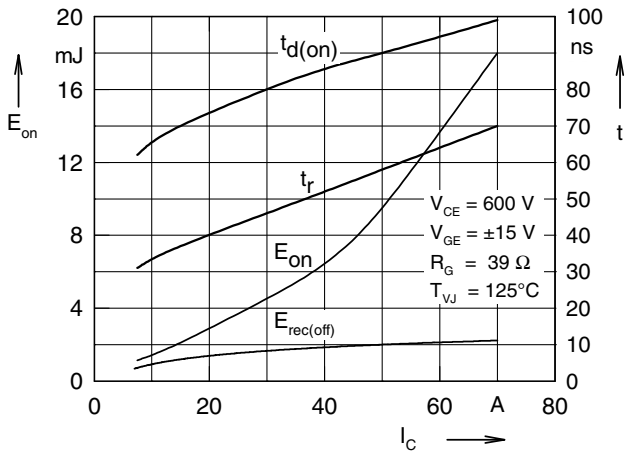

Fig. 7 Typ. turn on energy and switching times versus collector current

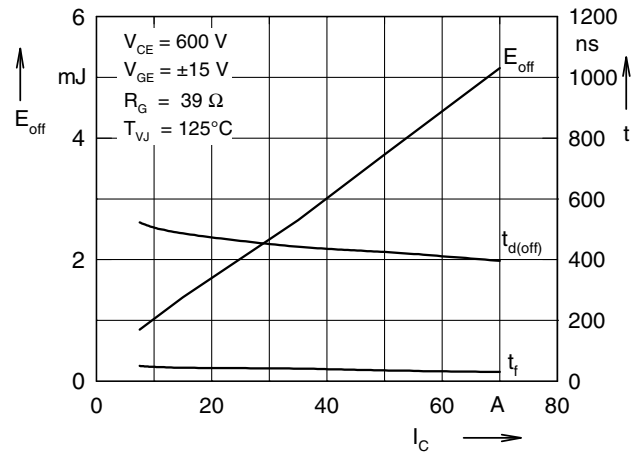

Fig. 8 Typ. turn off energy and switching times versus collector current

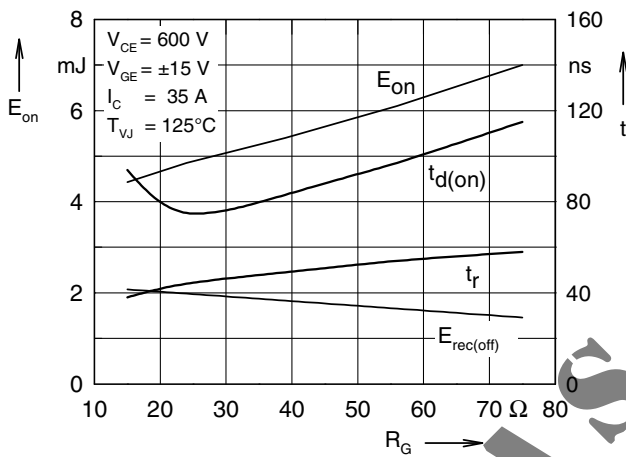

Fig. 9 Typ. turn on energy and switching times versus gate resistor

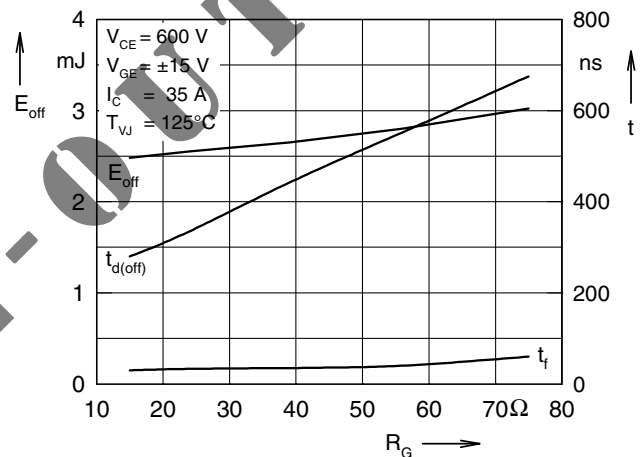

Fig. 10 Typ. turn off energy and switching times versus gate resistor

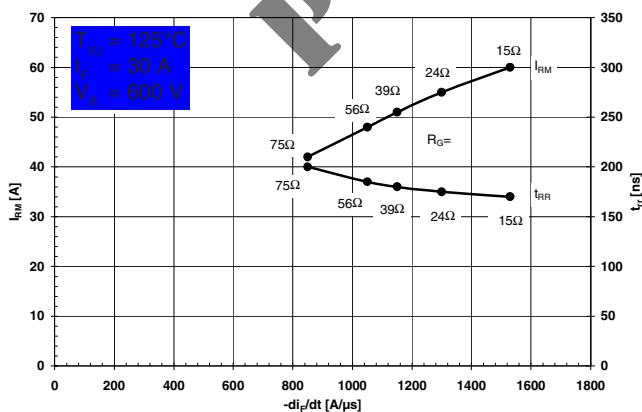

Fig. 11 Typ. turn off characteristics of free wheeling diode

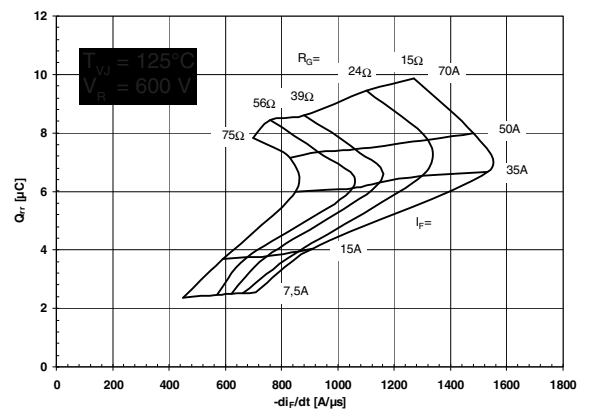

Fig. 12 Typ. turn off characteristics of free wheeling diode