

TMR6206L

6 Channels TMR Magnetic Pattern Recognition Sensor

General Description

The TMR6206L is a type of 6 channels magnetic pattern recognition sensor with high consistency, high sensitivity and high signal-to-noise ratio performance, it is used for detecting the paper bills, bank notes and security documents with magnetic anti-counterfeiting consists. The TMR6206L consist of TMR magneto-resistance sensor, high consistency magnet, high-strength plastic base and durable non-magnetic stainless steel cover.

Features and Benefits

- High SNR performance version
- Sensitivity matching of each channel
- Output voltage is independent of scanning speed
- Differential output, high CMRR performance
- Durable metal case, suitable for long time and heavy load situations
- 10mm x 6ch detection width, no non-detection area

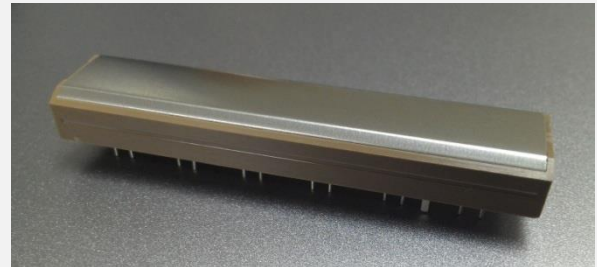

TMR6206L

Applications

- Bill and banknote counter and validator
- Bill and banknote sorter
- ATM
- Bill reader and validator in automated vending machines

Block Diagram & Pin Configuration

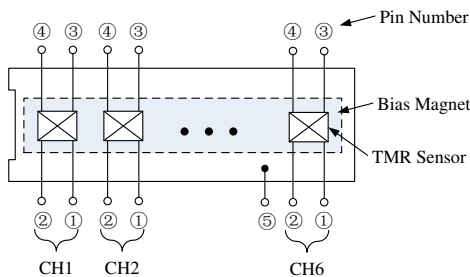

Block Diagram (Top View)

Pin No.	Symbol	Description
1	V+	Differential Positive output
2	V _{CC}	Power supply
3	V-	Differential Negative output
4	GND	Ground
5	Shell GND	Shell ground

Absolute Maximum Ratings

Parameter	Symbol	Rating	Unit
Maximum Supply Voltage	V_{CC}	5.5	V
Operating Temperature	T_A	-20 ~ 65	°C
Storage Temperature	T_{stg}	-30 ~ 85	°C
Operating Humidity	HMD	10 ~ 90 (no dew)	%RH
ESD (HBM)	V_{HBM}	2000	V

Electrical Property ($V_{CC}=5V$, $T_A=25^\circ C$)

Parameter	Symbol	Conditions	Min.	Typ.	Max.	Unit
Sensitivity	$S^{(1)}$			TBD		V_{PP}
Resistance	R	No external magnetic field	0.5		3	kOhm
Output Offset Voltage	V_{OS}		-75		75	mV/V
Noise	$V_N^{(2)}$			50		μV_{PP}
Surface Magnetic Field	B	On sensing surface (S pole)		800		G
Sensitivity Deviation	ΔS	$(S_{MAX} - S_{MIN}) / S_{MEAN}$	0		0.67	V/V
Number of Channels	C			6		
Detection Width per Channel	W			10		mm
Resolution	T			0.475		mm

Notes:

- (1) According to the MultiDimension sensitivity measurement.
- (2) The amplifier's gain is 10000V/V@1kHz, no external magnetic field applied, measure the peak-to-peak voltage V_{PP} , then $V_N = V_{PP}/10000$.

Caution for use

- The sensor contains a permanent magnet, it will cause the recordable magnetic media damaged, such as cassette tapes, floppy disks, credit cards, hard drives, keep it away from such types of magnetic media.
- To avoid the ferromagnetic particles being collected from a dirty environment.
- Magnets tend to snap to each other or the magnetic metals, be careful when handling the sensor not to apply mechanical shock, otherwise the sensors might be abnormal or break.
- Do not place the sensor near the person who has an electronic medical device. It is very dangerous and may cause malfunction of an electronic medical device.
- Magnetic devices may be subject to special transport regulations.
- To avoid the abrasion of the sensor's metal case or stuck the banknote, about 0.1mm gap between the sensor and the opposite side such as rollers is recommended to reduce the pressure of the sensor's metal case.
- To avoid excessive force on terminals, please mount the sensor's base firmly on the PCB and solder all the terminals.
- Hand soldering should be applied, the soldering temperature should be $350 \pm 10^\circ C$ less than 3 seconds or $260 \pm 5^\circ C$ less than 10 seconds

Outline Drawing and Dimensions

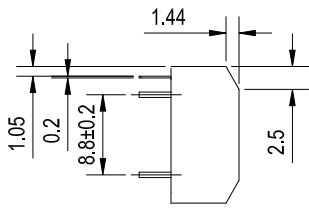

Side View

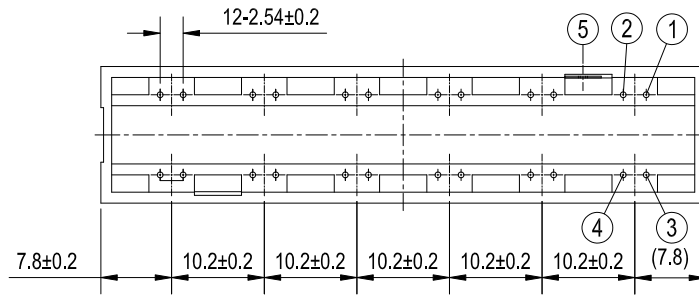

Bottom View

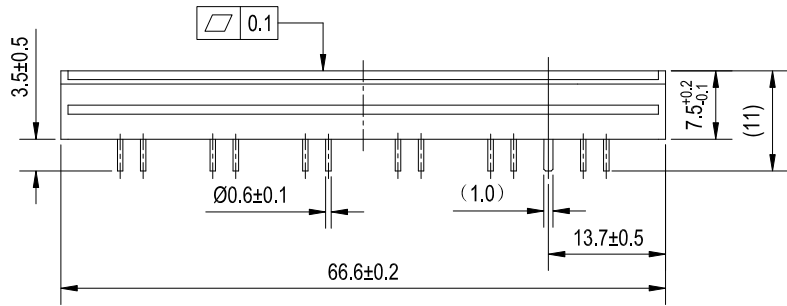

Front View

Case: plastic
 Cover: stainless steel thickness 0.2mm
 General tolerance: ±0.3
 Unit:mm

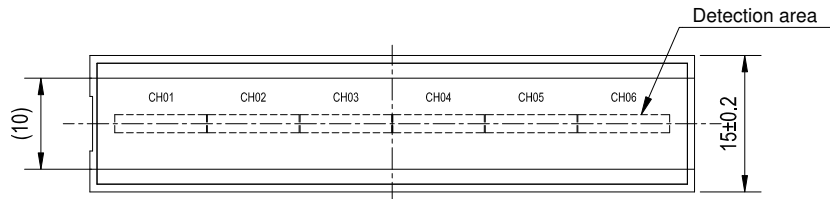

Top View

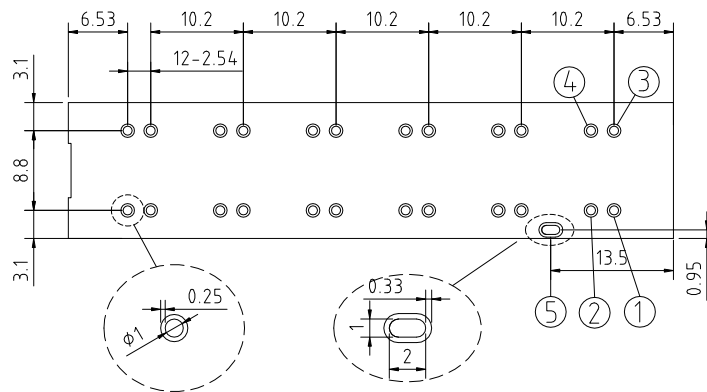

Recommended Pad Layout

Recommended Application Circuit

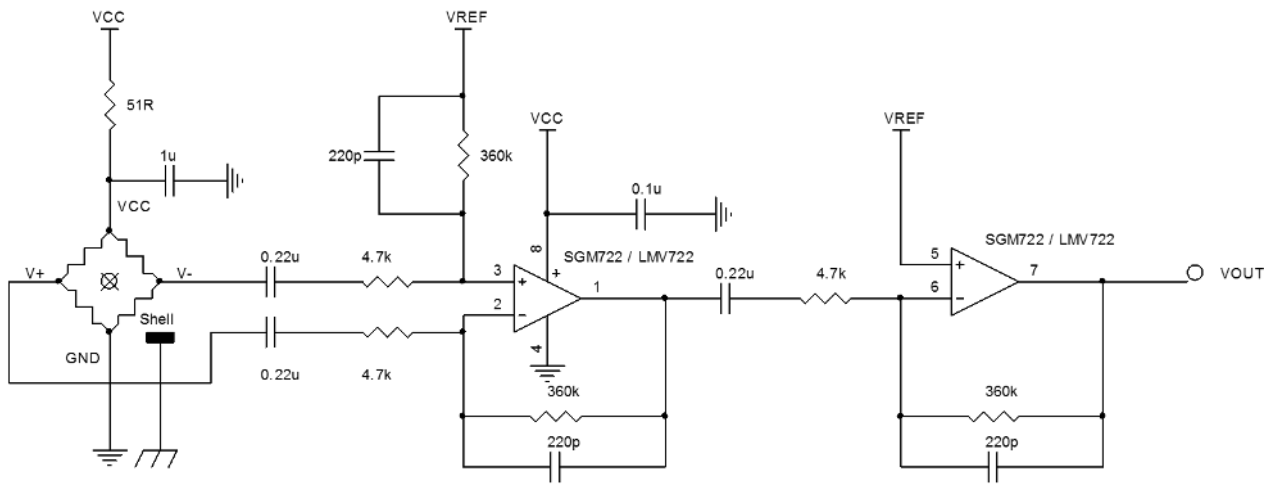

Notes:

Shell GND pin should be connected to the shielding ground.



MultiDimension Technology Co., Ltd.

Address: No. 7 Guangdong Road, Zhangjiagang Free Trade Zone, Jiangsu, 215634, China

Web: www.dowaytech.com/en

Email: info@dowaytech.com

The information provided herein by MultiDimension Technology Co., Ltd. (hereinafter MultiDimension) is believed to be accurate and reliable. Publication neither conveys nor implies any license under patent or other industrial or intellectual property rights. MultiDimension reserves the right to make changes to product specifications for the purpose of improving product quality, reliability, and functionality. MultiDimension does not assume any liability arising out of the application and use of its products. MultiDimension's customers using or selling this product for use in appliances, devices, or systems where malfunction can reasonably be expected to result in personal injury do so at their own risk and agree to fully indemnify MultiDimension for any damages resulting from such applications.