

Ceramic Bandpass Filter

50Ω 2400 to 2550 MHz

BFCN-2450+

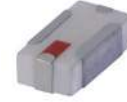

Generic photo used for illustration purposes only

CASE STYLE: FV1206-4

+RoHS Compliant

The +Suffix identifies RoHS Compliance. See our web site for RoHS Compliance methodologies and qualifications



Available Tape and Reel at no extra cost

Reel Size	Devices/Reel
7"	20, 50, 100, 200, 500, 1000, 3000

Features

- Small size (0.126"x0.063"x0.037")
- Temperature stable
- Hermetically sealed
- LTCC construction

Applications

- Harmonic rejection
- Transmitters / Receivers
- ISM band
- Blue tooth

Specification Definition

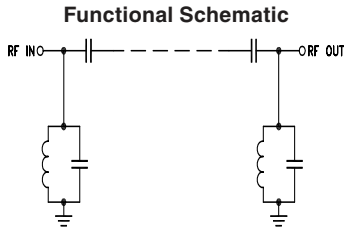
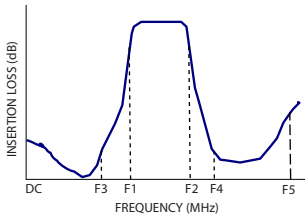

Functional Schematic

Top View

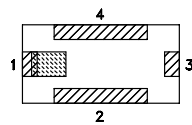

Pad Connections

Input	1
Output	3
Ground	2,4

Electrical Specifications^{1,2} at 25°C

Parameter	F#	Frequency (MHz)	Min.	Typ.	Max.	Unit
Pass Band	Center Frequency	—	—	2450	—	MHz
	Insertion Loss	F1 - F2	2400 - 2550	—	2.0	dB
	VSWR	F1 - F2	2400 - 2550	—	1.4	:1
Stop Band, Lower	Insertion Loss	DC - F3	DC - 2100	—	30	dB
	VSWR	DC - F3	DC - 2100	—	30	:1
Stop Band, Upper	Insertion Loss	F4 - F5	3400 - 12000	—	20	dB
	VSWR	F4 - F5	3400 - 12000	—	30	:1

1. Measured on Mini-Circuits Characterization Test Board TB-518+.

2. This filter is not intended for use as a DC Blocking circuit element. In Application where DC voltage is present at either input or output ports, blocking capacitors are required at the corresponding RF port.

Maximum Ratings

Operating Temperature	-40°C to +85°C
Storage Temperature	-55°C to +100°C
RF Power Input*	2W at 25°C

*Passband rating, derate linearly to 0.5W at 85°C ambient
Permanent damage may occur if any of these limits are exceeded.

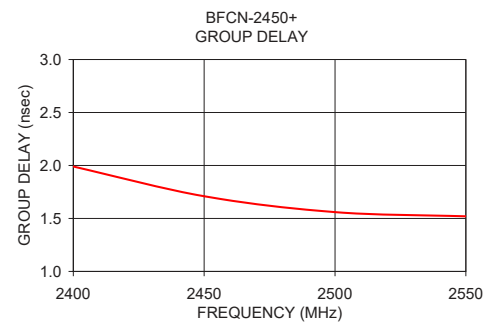
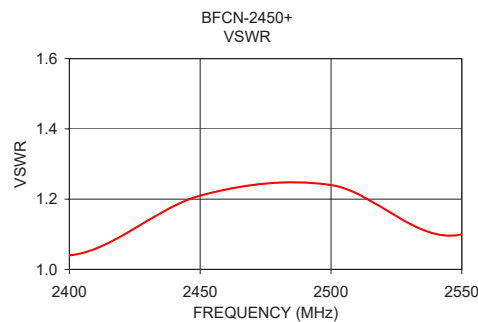
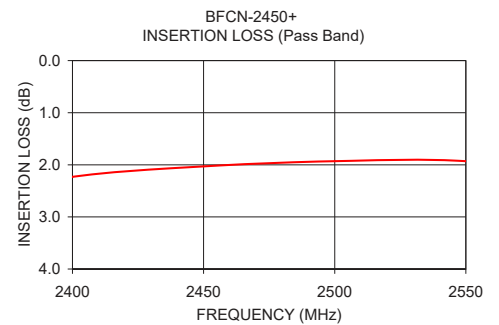
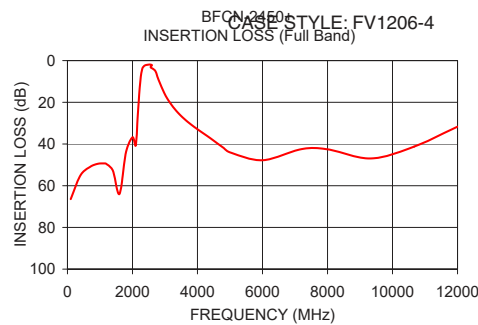

Full Band Performance

Pass Band Performance

Frequency (MHz)	Insertion Loss (dB)	VSWR (:1)	Frequency (MHz)	Insertion Loss (dB)	Group Delay (nsec)
100.00	66.45	179.21	2400.00	2.23	1.99
700.00	50.93	91.48	2450.00	2.03	1.71
1200.00	49.59	77.10	2500.00	1.93	1.56
2000.00	36.75	32.32	2550.00	1.93	1.52
2150.00	29.41	14.28			
2300.00	3.98	1.43			
2400.00	2.23	1.04			
2550.00	1.93	1.10			
2560.00	3.22	2.35			
3000.00	16.22	28.51			
3400.00	24.98	51.59			
4000.00	32.93	57.94			
5000.00	44.03	51.22			
8000.00	42.55	51.41			
12000.00	31.70	16.01			

Pad Connections

Input	1
Output	3
Ground	2,4

Outline Drawing

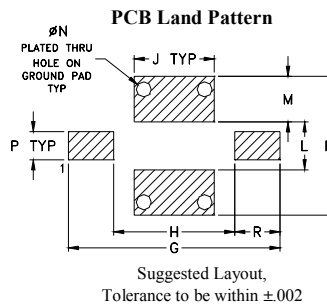
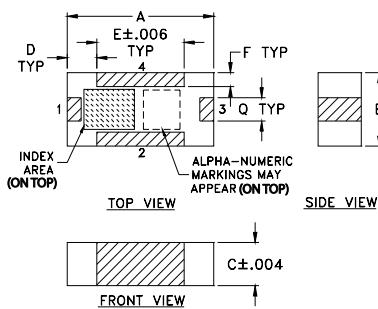

Demo Board MCL P/N: TB-518+ Suggested PCB Layout (PL-305)

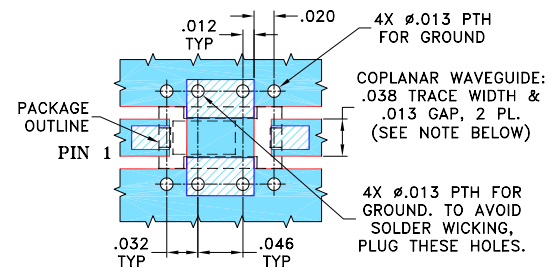

- NOTE: 1. TRACE WIDTH IS SHOWN FOR ROGERS R04350B WITH DIELECTRIC THICKNESS $.020" \pm .0015"$. COPPER: 1/2 OZ. EACH SIDE. FOR OTHER MATERIALS TRACE WIDTH MAY NEED TO BE MODIFIED.
2. BOTTOM SIDE OF THE PCB IS CONTINUOUS GROUND PLANE.

- DENOTES PCB COPPER LAYOUT WITH SMOBC (SOLDER MASK OVER BARE COPPER)
- DENOTES COPPER LAND PATTERN FREE OF SOLDER MASK

Outline Dimensions (inch/mm)

A	B	C	D	E	F	G	H	J
.126	.063	.037	.026	.075	.012	.182	.104	.069
3.20	1.60	0.94	0.66	1.91	0.30	4.62	2.64	1.75
K	L	M	N	P	Q	R	wt	
.119	.041	.039	.013	.024	.020	.039	grams	
3.02	1.04	0.99	0.33	0.61	0.51	0.99	.020	

Additional Notes

- A. Performance and quality attributes and conditions not expressly stated in this specification document are intended to be excluded and do not form a part of this specification document.
- B. Electrical specifications and performance data contained in this specification document are based on Mini-Circuit's applicable established test performance criteria and measurement instructions.
- C. The parts covered by this specification document are subject to Mini-Circuits standard limited warranty and terms and conditions (collectively, "Standard Terms"); Purchasers of this part are entitled to the rights and benefits contained therein. For a full statement of the Standard Terms and the exclusive rights and remedies thereunder, please visit Mini-Circuits' website at www.minicircuits.com/MCLStore/terms.jsp