

RTEN SERIES

Multipurpose Three-Phase Filter with Many Current Variations

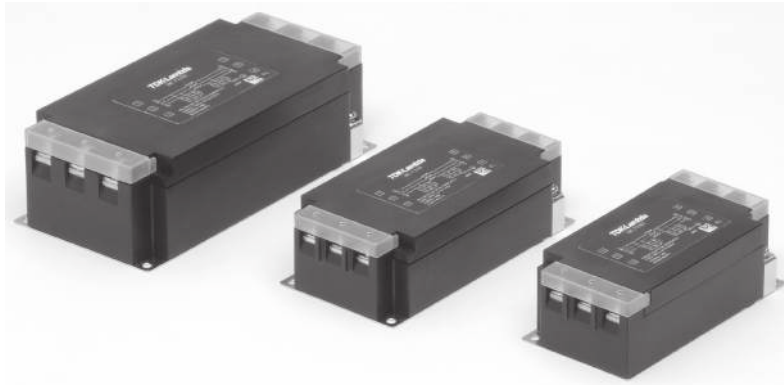

FEATURES

- 6 to 300A wide range lineup.
- Small due to L1, light and thin.
- Low-profile design.
- Self-tightening screws and an open/close type cover make wiring work easier.
- Terminal block cover included for safety.
- DIN rail installation compatible type is also available.

SAFETY STANDARDS

UL1283
EN60939-1/-2
(ENEC14)

UL File No. E62388 (Up to 200A)
Licence Ref. No. SE/07115-5 (Up to 60A)
Licence Ref. No. SE/07115-4 (From 80A)

PRODUCT IDENTIFICATION

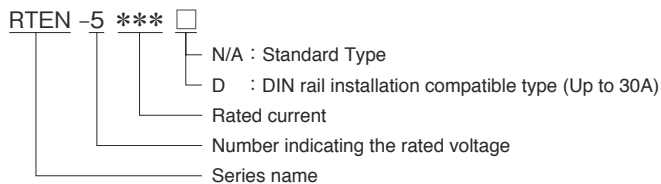

CONFORMITY TO RoHS Directive

CIRCUIT DIAGRAM

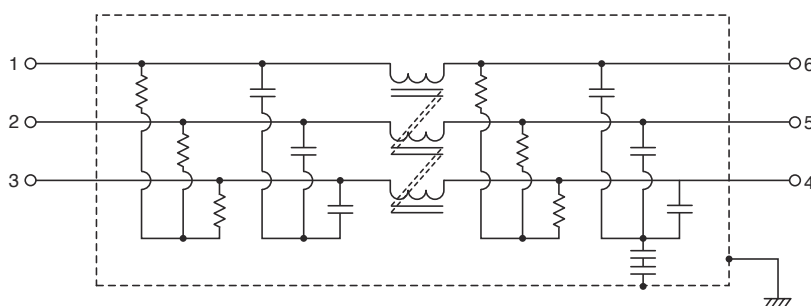

ELECTRICAL CHARACTERISTICS

Part No.	Rated voltage (AC/DC)	Rated current (AC/DC)	Withstand voltage	Insulation resistance	Leakage current	Operating temperature range	With derating over	DC resistance (mΩ)	Attenuation frequency range (MHz)			Weight (kg)
									Common mode		Differential mode	
									at 25dB	at 10dB	at 25dB	
RTEN-5006	500V	6A	AC.2500V 60s [Between line to ground]	100MΩ min. [DC.500V/ 1min]	2.5mA max. [250V/60Hz] 5mA max. [500V/60Hz]	-25 to +85°C	50°C	145 max.	0.2 to 10	-	0.2 to 30	0.36
RTEN-5010		10A						60 max.	0.2 to 10	-	0.2 to 30	0.36
RTEN-5020		20A						25 max.	0.3 to 8	-	0.2 to 30	0.56
RTEN-5030		30A						13 max.	0.5 to 8	-	0.2 to 30	0.56
RTEN-5040		40A						10 max.	0.3 to 7	-	0.2 to 30	1.10
RTEN-5050		50A						7 max.	0.5 to 7	-	0.2 to 30	1.10
RTEN-5060		60A						5 max.	0.7 to 5	-	0.2 to 30	1.10
RTEN-5080		80A						5 max.	0.3 to 5	-	0.2 to 5	3.90
RTEN-5100		100A						4 max.	0.3 to 5	-	0.2 to 5	4.20
RTEN-5150		150A						3 max.	0.3 to 5	-	0.2 to 5	6.50
RTEN-5200		200A						2 max.	0.5 to 5	-	0.2 to 5	9.20
RTEN-5250		250A						1.5 max.	-	0.5 to 10	0.2 to 5	8.70
RTEN-5300		300A						1 max.	-	0.5 to 10	0.2 to 5	8.30

DERATING GRAPH

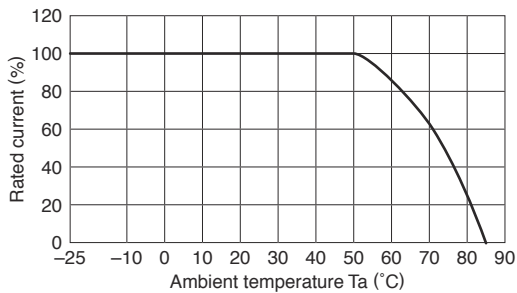

MECHANICAL

RTEN-5006/5010

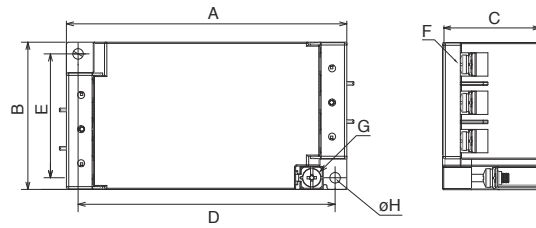

RTEN-5020/5030/5040/5050/5060

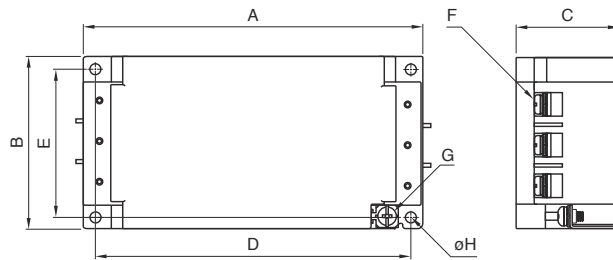

Dimensions in mm

Part No.	A	B	C	D	E	F	G	φ H	Recommended clamping torque
RTEN-5006	120	63	42	110	53	M4	M4	4.5	M4 : 1.27N · m M5 : 2.5N · m
RTEN-5010									
RTEN-5020	140	70	42	130	60	M4	M4	4.5	
RTEN-5030									
RTEN-5040	170	90	54	160	80	M5	M4	4.5	
RTEN-5050									
RTEN-5060									

RTEN-5080/5100/5150

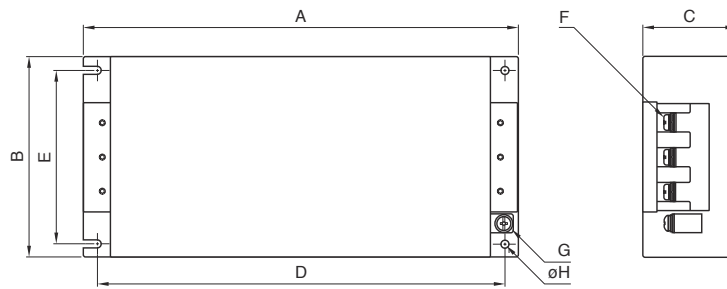

RTEN-5200/5250/5300

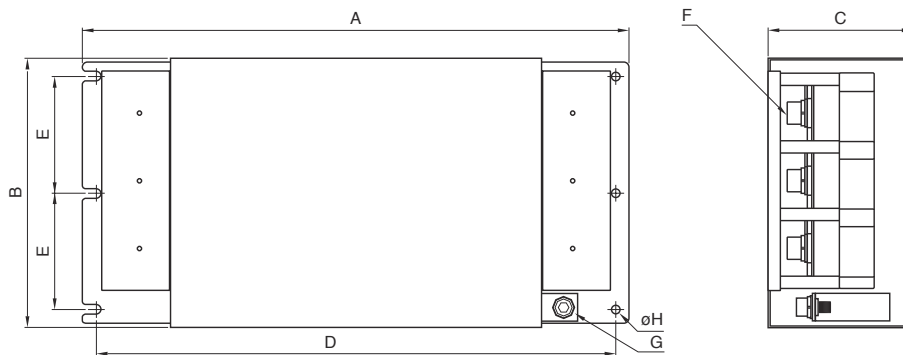

Dimensions in mm

Part No.	A	B	C	D	E	F	G	φH	Recommended clamping torque
RTEN-5080	267	161	85	247	135	M8	M6	6.5	M6 : 4.8N · m M8 : 7.64N · m
RTEN-5100									
RTEN-5150	290	190	88	270	164	M8	M6	6.5	M10 : 11.8N · m
RTEN-5200	390	195	103	370	84.5	M10	M8	6.5	
RTEN-5250									
RTEN-5300									

RTEN-5006D/5010D

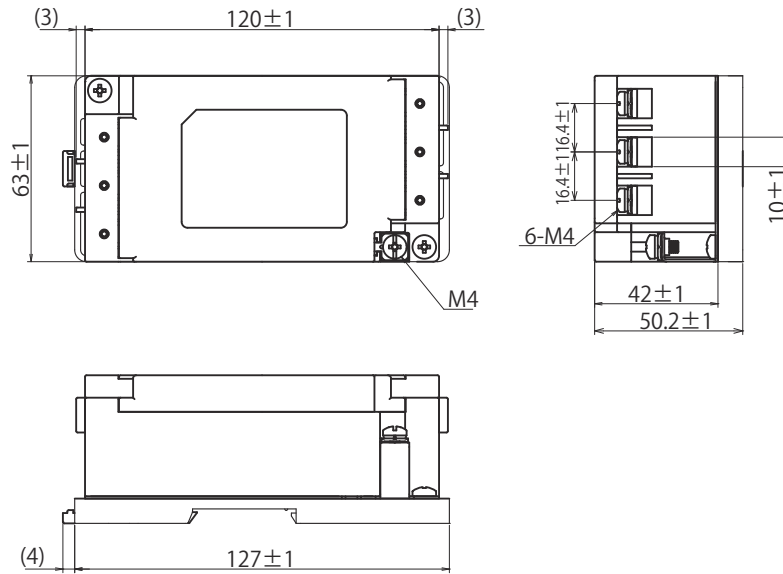

RTEN-5020D/5030D

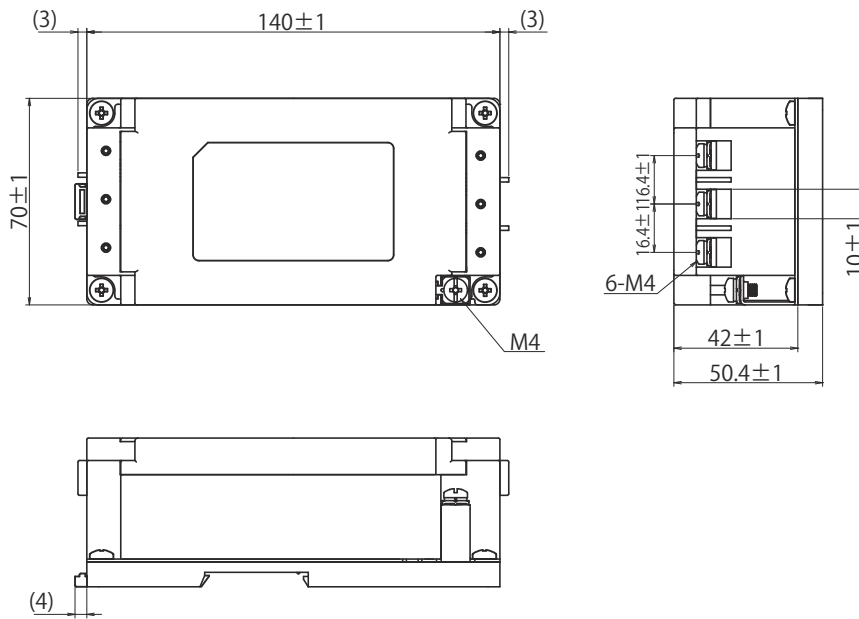

Dimensions in mm

*Please see the next page: "Precautions of DIN rail mounting".

Precautions of DIN rail mounting

When installing on a DIN rail, secure a space with a depth of 14 mm or more from the top of the rail. If there is no depth space, the tip of the DIN attachment and the installation surface may interfere and it may not be possible to install it.

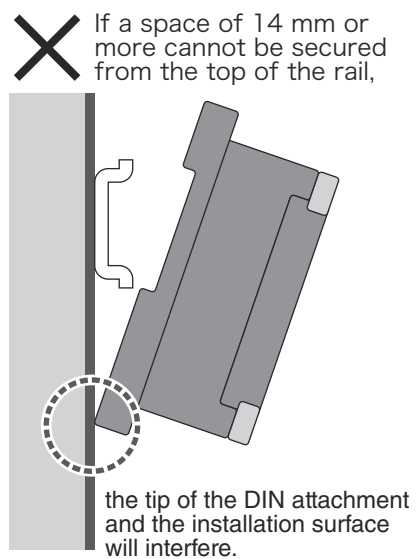
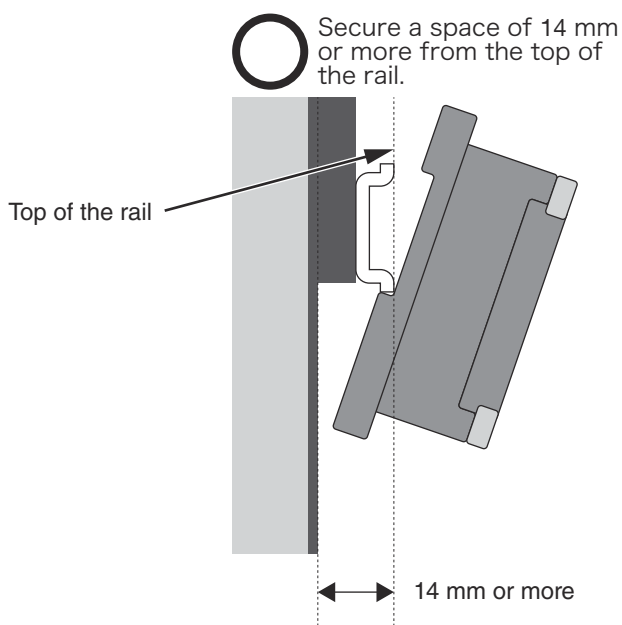

■ ATTENUATION vs. FREQUENCY CHARACTERISTICS

RTEN-5006

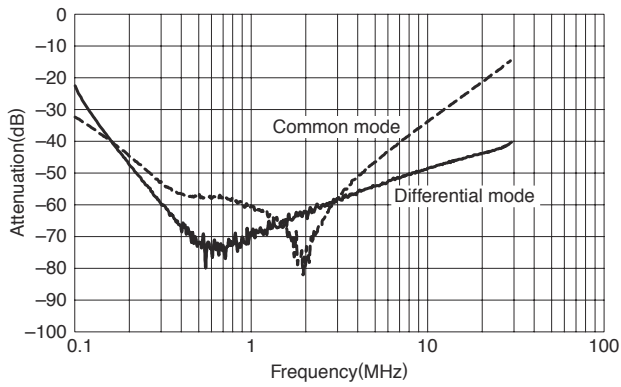

RTEN-5010

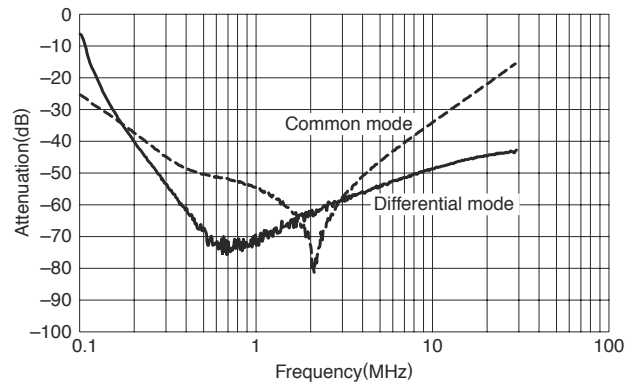

RTEN-5020

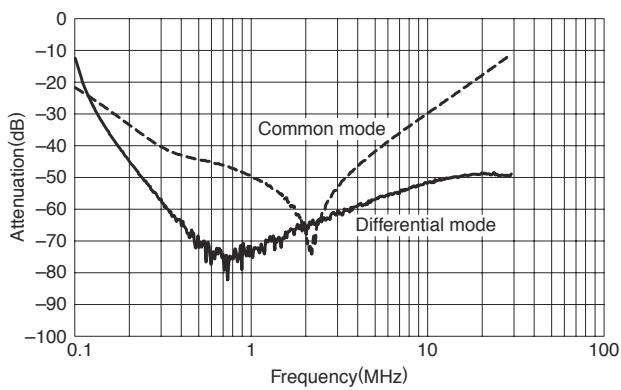

RTEN-5030

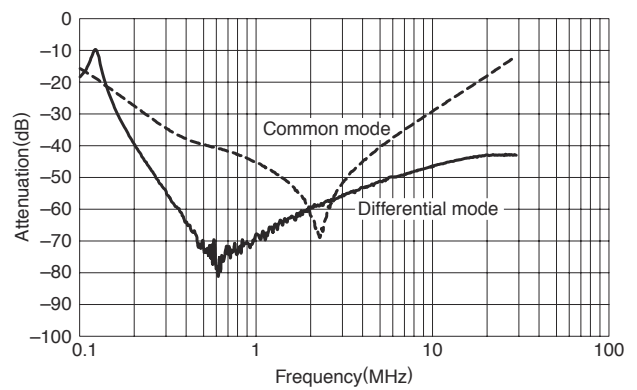

RTEN-5040

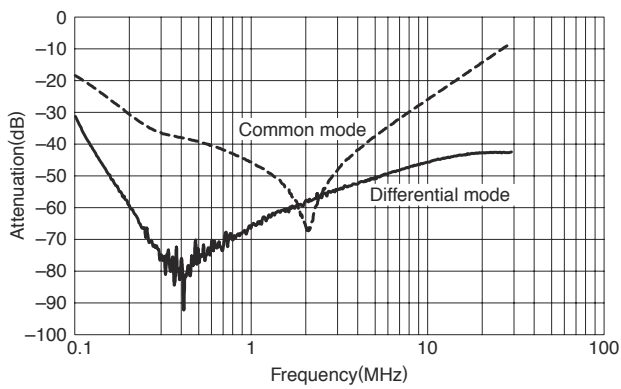

RTEN-5050

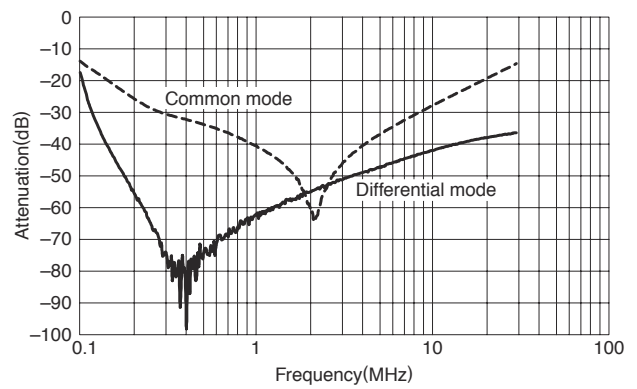

RTEN-5060

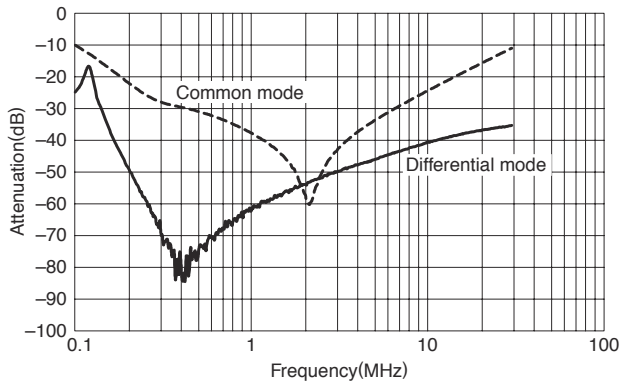

RTEN-5080

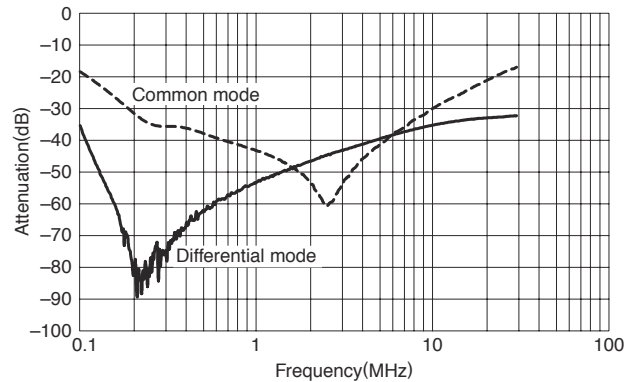

RTEN-5100

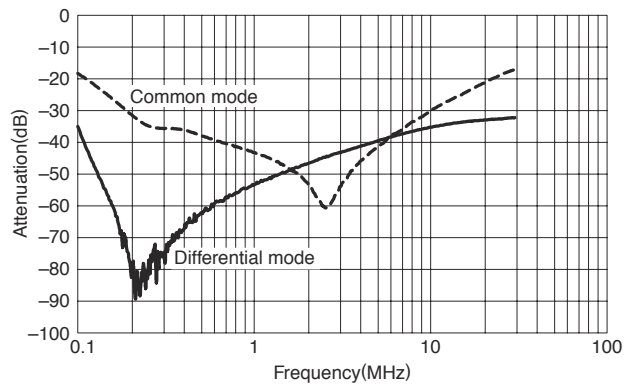

RTEN-5150

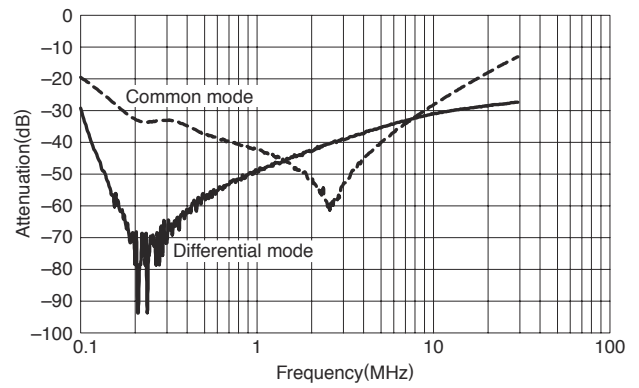

RTEN-5200

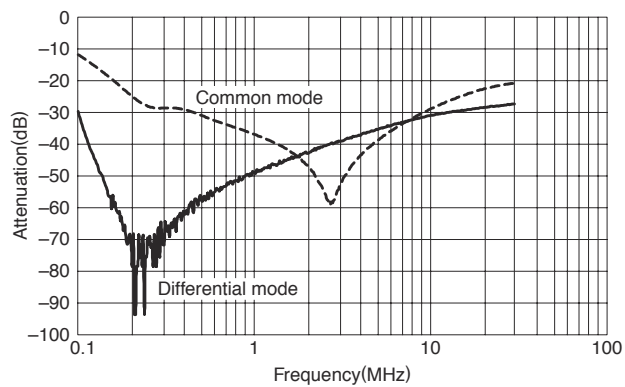

RTEN-5250

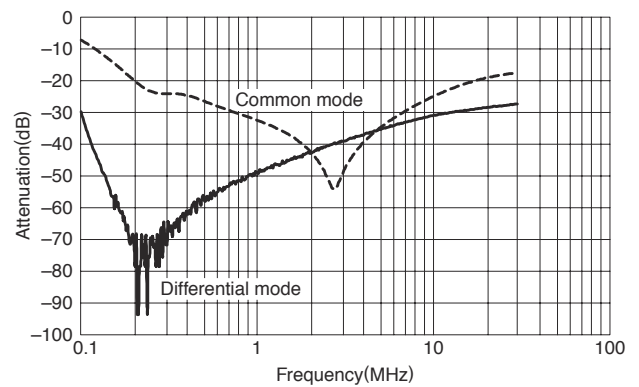

RTEN-5300

