

CPDFR5V0H-HF

RoHS Device
Halogen Free



Features

- Bi-directional ESD protection
- IEC 61000-4-5 (surge) ; IPP=7A
- IEC 61000-4-2 (ESD) ; ±30KV(contact)
- Low clamping voltage
- Low leakage current

Mechanical data

- Case: 1005/SOD-323F Standard package , molded plastic.
- Terminals: Gold plated, solderable per MIL-STD-750, method 2026.
- Marking Code: E05
- Mounting position: Any.
- Weight: 0.003 gram (approx.).

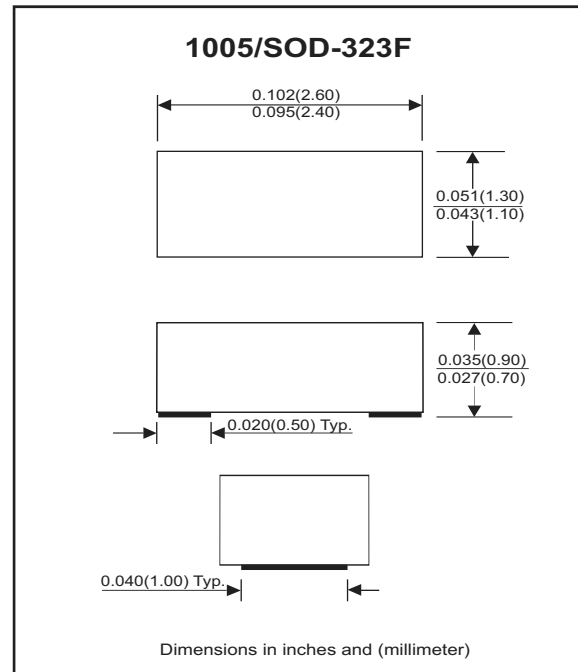

Maximum Rating and Electrical Characteristics (at TA=25 °C unless otherwise noted)

Parameter	Conditions	Symbol	Min	Typ	Max	Unit
Diode breakdown voltage	I _R = 1mA	V _{BD}	5.5	7.0		V
Leakage current	V _R = 5V	I _L			1.0	uA
Junction capacitance	V _R = 0V, f = 1MHz	C _T			20	pF
ESD capability	IEC 61000-4-2(air)	ESD			30	kV
	IEC 61000-4-2(contact)	ESD			30	kV
Clamping Voltage	I _{PP} = 1 A, t _p =8/20us	V _c			11	V
	I _{PP} = 7 A, t _p =8/20us	V _c			20	V
Peak Pulse Power	T _p =8/20us	P _{PP}			140	W
Operation temperature		T _j			125	°C
Storage temperature		T _{STG}	-55		150	°C

RATING AND CHARACTERISTIC CURVES (CPDFR5V0H-HF)

Fig. 1 - 8/20us Peak pulse current waveform acc. IEC 61000-4-5

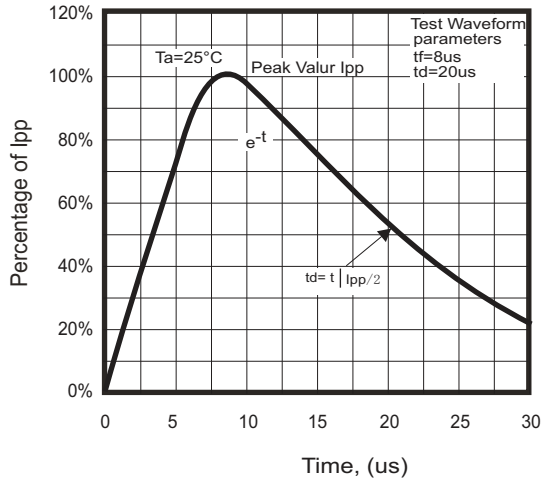

Fig. 2 - Capacitance between terminals characteristics

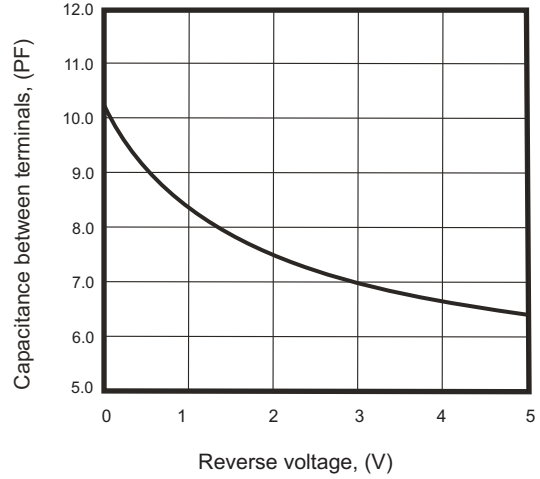

Fig.3 - Clamping voltage vs. peak pulse current

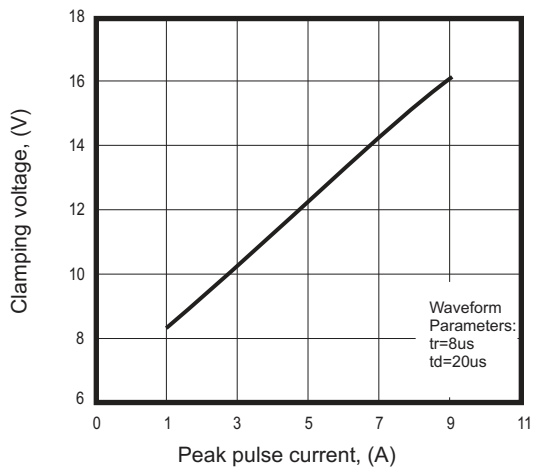
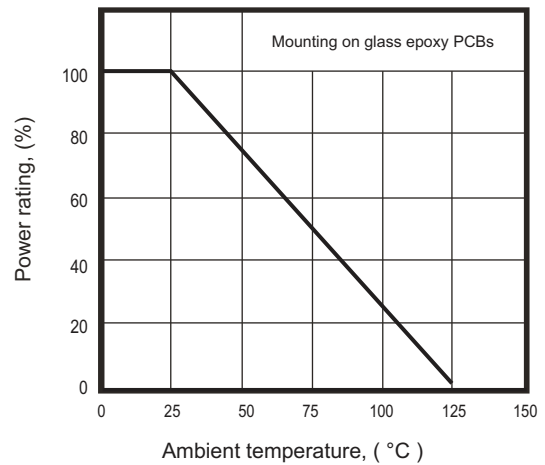
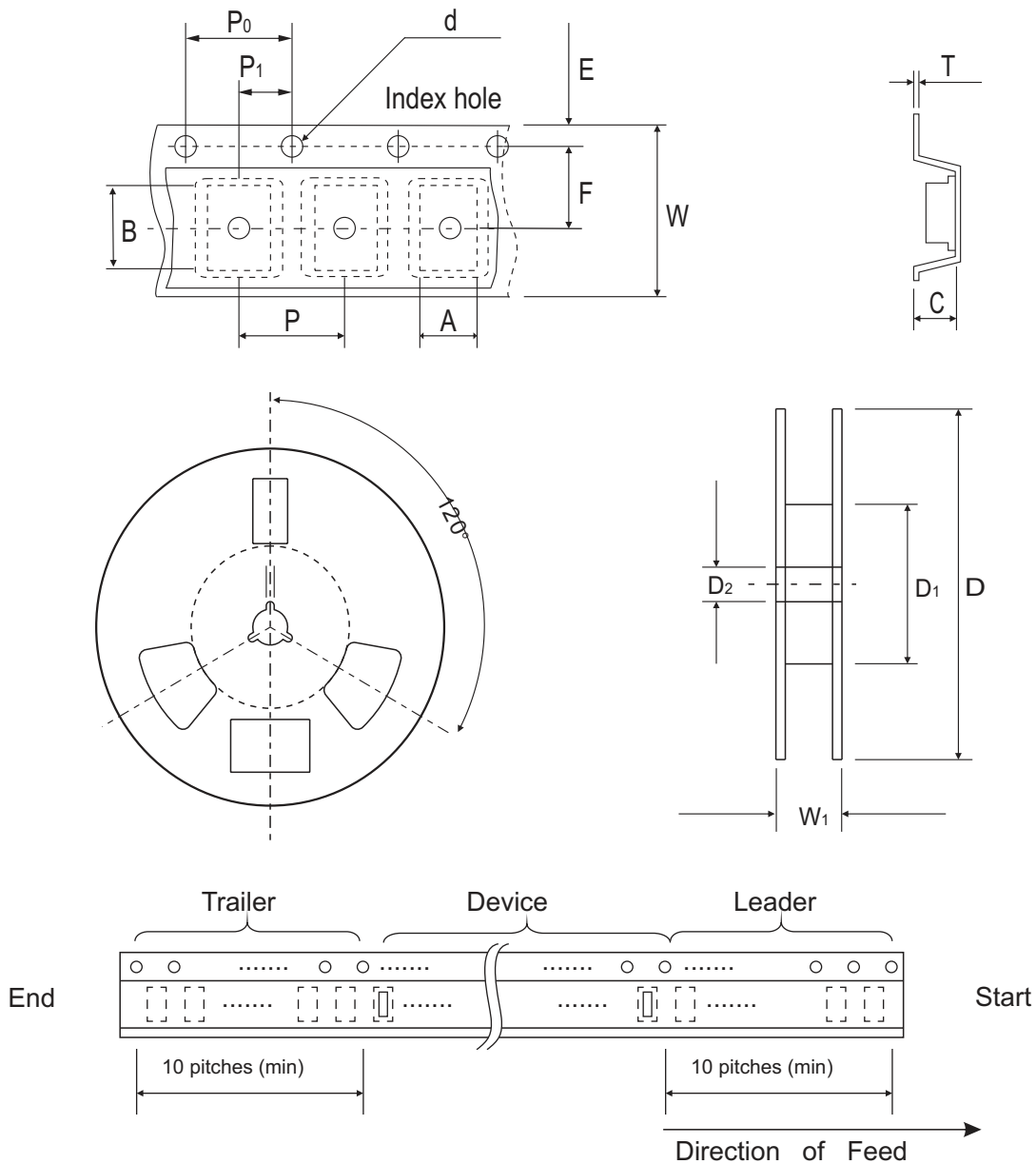

Fig. 4 - Power rating derating curve



Reel Taping Specification



1005 (SOD-323F)	SYMBOL	A	B	C	d	D	D ₁	D ₂
	(mm)	1.55 ± 0.10	2.65 ± 0.10	1.05 ± 0.10	1.55 ± 0.05	178 ± 1	60.0 MIN.	13.0 ± 0.20
	(inch)	0.061 ± 0.004	0.104 ± 0.004	0.041 ± 0.004	0.061 ± 0.002	7.008 ± 0.04	2.362 MIN.	0.512 ± 0.008

1005 (SOD-323F)	SYMBOL	E	F	P	P ₀	P ₁	T	W	W ₁
	(mm)	1.75 ± 0.10	3.50 ± 0.05	4.00 ± 0.10	4.00 ± 0.10	2.00 ± 0.05	0.23 ± 0.05	8.00 ± 0.20	13.5 MAX.
	(inch)	0.069 ± 0.004	0.138 ± 0.002	0.157 ± 0.004	0.157 ± 0.004	0.079 ± 0.004	0.009 ± 0.002	0.315 ± 0.008	0.531 MAX.

Marking Code

Part Number	Marking Code
CPDFR5V0H-HF	E05

E05

Suggested PAD Layout

SIZE	1005/SOD-323F	
	(mm)	(inch)
A	2.00	0.079
B	0.70	0.028
C	1.30	0.051
D	2.70	0.106
E	1.30	0.051

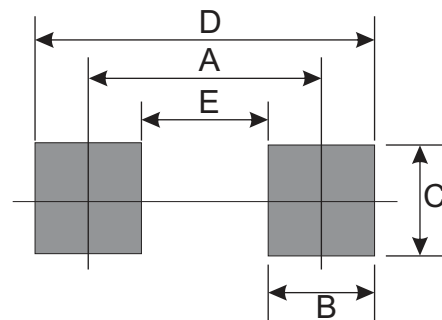

Standard Packaging

Case Type	REEL PACK	
	REEL (pcs)	Reel Size (inch)
1005/SOD-323F	4,000	7