

## Solid-state relays - ST-OV3-120AC/ 60DC/3 - 2903613

Please be informed that the data shown in this PDF Document is generated from our Online Catalog. Please find the complete data in the user's documentation. Our General Terms of Use for Downloads are valid (<http://phoenixcontact.com/download>)



Plug-in power solid-state relay, with LED and protective circuit in input and output circuits, input: 120 V AC, output: 12 - 60 V DC/max. 3 A, can be plugged into basic terminal blocks

The illustration shows version ST-OV  
3- 5 DC/60 DC/3



### Key commercial data

Packing unit	1 pc
GTIN	 4 017918 079062
Weight per Piece (excluding packing)	60.83 GRM
Custom tariff number	85364900
Country of origin	Germany

### Technical data

#### Dimensions

Width	20.8 mm
Height	33 mm
Depth	66.5 mm

#### Ambient conditions

Ambient temperature (operation)	-20 °C ... 60 °C
Ambient temperature (storage/transport)	-20 °C ... 70 °C

#### Input data

Nominal input voltage $U_N$	120 V AC $\pm 20$ %
Switching threshold "0" signal in reference to $U_N$	$\leq 0.4$
Switching threshold "1" signal in reference to $U_N$	$\geq 0.8$
Typical input current at $U_N$	4 mA

## Solid-state relays - ST-OV3-120AC/ 60DC/3 - 2903613

### Technical data

#### Input data

Typical response time	3 ms
Typical turn-off time	13 ms
Transmission frequency	10 Hz

#### Output data

Output voltage range	12 V DC ... 60 V DC
Limiting continuous current	3 A (see derating curve)
Surge current	5 A (t = 1 s)
Peak offstate voltage	70 V DC (Collector-emitter reverse voltage)
Voltage drop at max. limiting continuous current	1.2 V
Output circuit	2-wire, floating
Type of protection	Protection against polarity reversal
	Surge protection
Protective circuit/component	Polarity protection diode

#### General

Test voltage input/output	2.5 kV AC
Mounting position	any
Standards/regulations	IEC 60664
	IEC 60664 A
	DIN VDE 0110

### Classifications

#### eCl@ss

eCl@ss 4.0	27371102
eCl@ss 4.1	27371102
eCl@ss 5.0	27371001
eCl@ss 5.1	27371001
eCl@ss 6.0	27371001
eCl@ss 7.0	27371001
eCl@ss 8.0	27371001

#### ETIM

ETIM 2.0	EC001504
ETIM 3.0	EC001504
ETIM 4.0	EC001504
ETIM 5.0	EC001504

## Solid-state relays - ST-OV3-120AC/ 60DC/3 - 2903613

### Classifications

#### UNSPSC

UNSPSC 6.01	30211916
UNSPSC 7.0901	39121542
UNSPSC 11	39121542
UNSPSC 12.01	39121542
UNSPSC 13.2	39121542

### Approvals

#### Approvals

---

#### Approvals

#### GOST / GOST

---

#### Ex Approvals

---

#### Approvals submitted

---

### Approval details

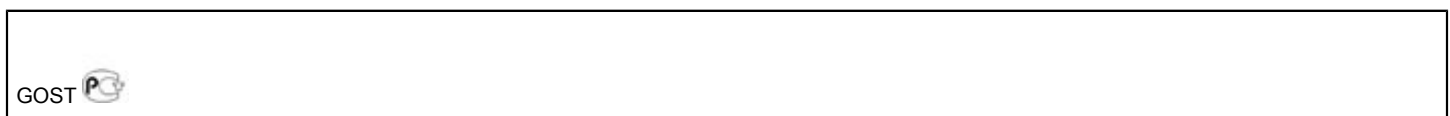

### Drawings

# Solid-state relays - ST-OV3-120AC/ 60DC/3 - 2903613

Diagram

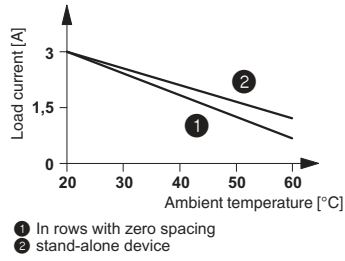

Circuit diagram

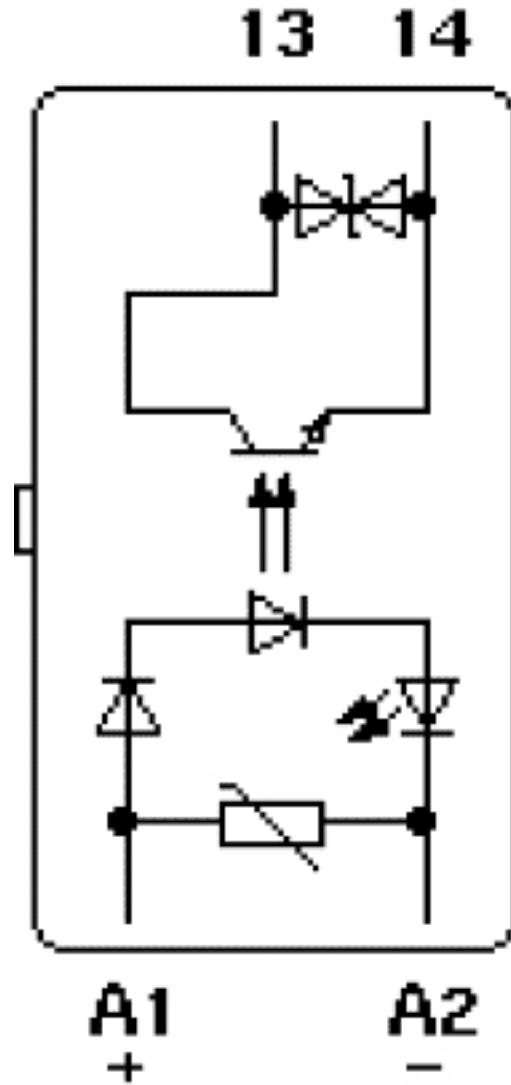

## Solid-state relays - ST-OV3-120AC/ 60DC/3 - 2903613

Circuit diagram

