

Printed-circuit board connector - DMC 1,5/ 5-G1F-3,5-LRP20THRR56 - 1818533

Please be informed that the data shown in this PDF Document is generated from our Online Catalog. Please find the complete data in the user's documentation. Our General Terms of Use for Downloads are valid (<http://phoenixcontact.com/download>)



Header, Nominal current: 8 A, Rated voltage (III/2): 160 V, Number of positions: 5, Pitch: 3.5 mm, Color: black, Contact surface: Tin, Mounting: THR soldering

The figure shows a 10-pos. version with 20 contacts

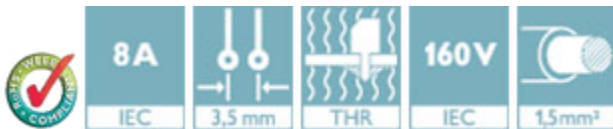

Key Commercial Data

Packing unit	1 pc
Minimum order quantity	180 pc
Custom tariff number	85366990
Country of origin	Germany

Technical data

Dimensions

Length	11.6 mm
Pitch	3.50 mm
Dimension a	14 mm
Constructional height	10.8 mm
Height	12.8 mm
Length of the solder pin	2 mm
Pin dimensions	0,8 x 0,8 mm
Pin spacing	2.50 mm
Hole diameter	1.4 mm

General

Range of articles	DMC 1,5/...G1F-THR
-------------------	--------------------

Printed-circuit board connector - DMC 1,5/ 5-G1F-3,5-LRP20THRR56 - 1818533

Technical data

General

Insulating material group	IIIa
Rated surge voltage (III/3)	2.5 kV
Rated surge voltage (III/2)	2.5 kV
Rated surge voltage (II/2)	2.5 kV
Rated voltage (III/3)	160 V
Rated voltage (III/2)	160 V
Rated voltage (II/2)	250 V
Connection in acc. with standard	EN-VDE
Nominal current I _N	8 A
Maximum load current	8 A
Insulating material	LCP
Flammability rating according to UL 94	V0
Color	black
Number of positions	5

Standards and Regulations

Connection in acc. with standard	EN-VDE
	CUL
Flammability rating according to UL 94	V0

Classifications

eCl@ss

eCl@ss 4.0	272607xx
eCl@ss 4.1	27260701
eCl@ss 5.0	27260701
eCl@ss 5.1	27260701
eCl@ss 6.0	27260704
eCl@ss 7.0	27440402
eCl@ss 8.0	27440402
eCl@ss 9.0	27440402

ETIM

ETIM 3.0	EC001121
ETIM 4.0	EC002637
ETIM 5.0	EC002637

Printed-circuit board connector - DMC 1,5/ 5-G1F-3,5-LRP20THRR56 - 1818533

Classifications

UNSPSC

UNSPSC 6.01	30211810
UNSPSC 7.0901	39121409
UNSPSC 11	39121409
UNSPSC 12.01	39121409
UNSPSC 13.2	39121409

Approvals

Approvals

Approvals

VDE Gutachten mit Fertigungsüberwachung / IECCE CB Scheme / cULus Recognized / EAC

Ex Approvals

Approvals submitted

Approval details

VDE Gutachten mit Fertigungsüberwachung 	
Nominal current IN	8 A
Nominal voltage UN	160 V

IECEE CB Scheme 	
Nominal current IN	8 A
Nominal voltage UN	160 V

Printed-circuit board connector - DMC 1,5/ 5-G1F-3,5-LRP20THRR56 - 1818533

Approvals

cULus Recognized		
	B	C
Nominal current I _N	8 A	8 A
Nominal voltage U _N	150 V	50 V

EAC

Drawings

Schematic diagram

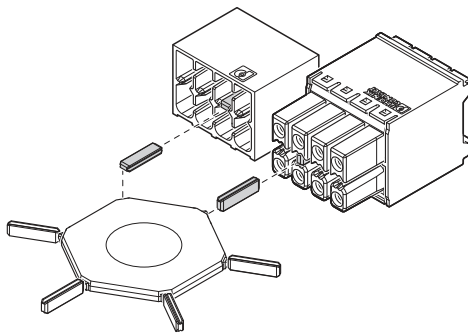

Drilling diagram

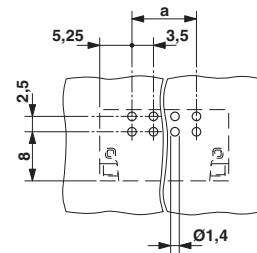

Use of the CP-DMC... coding profile

Diagram

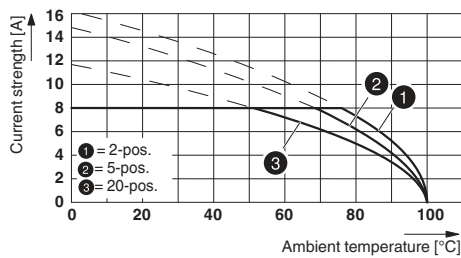

Dimensional drawing

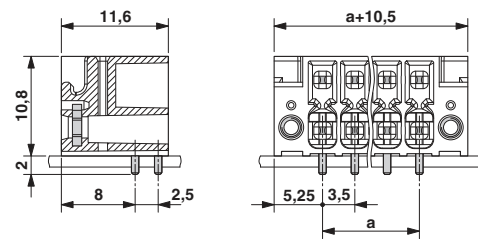

Printed-circuit board connector - DMC 1,5/ 5-G1F-3,5- LRP20THRR56 - 1818533

Schematic diagram

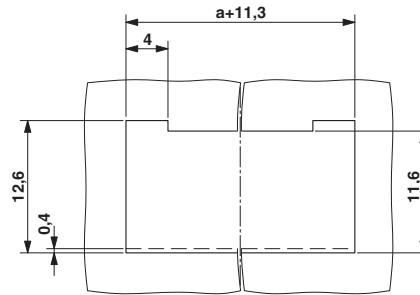

Panel cutout

Phoenix Contact 2016 © - all rights reserved
<http://www.phoenixcontact.com>