

FP7G100US60

Transfer Molded Type IGBT Module

General Description

Fairchild's New IGBT Modules (Transfer Molded Type) provide low conduction and switching losses as well as short circuit ruggedness. They are designed for applications such as Motor control, Uninterrupted Power Supplies (UPS) and general Inverters where short circuit ruggedness is a required feature.

Features

- Short Circuit rated 10us @Tc=100°C, Vge=15V
- High Speed Switching
- Low Saturation Voltage : Vce(sat) =2.2V @Ic=100A
- High Input Impedance
- Fast & Soft Anti-Parallel FWD

Application

- Welders
- AC & DC Motor Controls
- General Purpose Inverters
- Robotics
- Servo Controls
- UPS

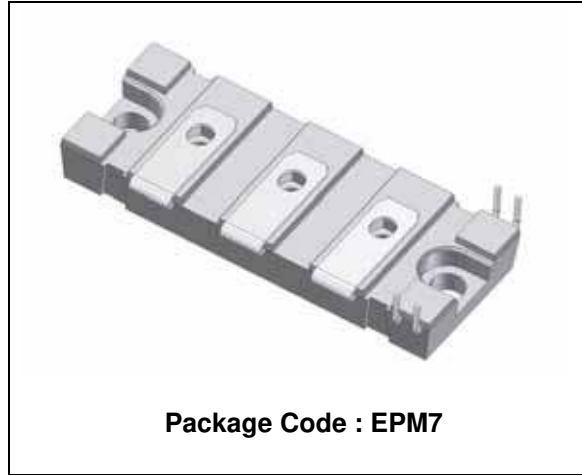

Package Code : EPM7

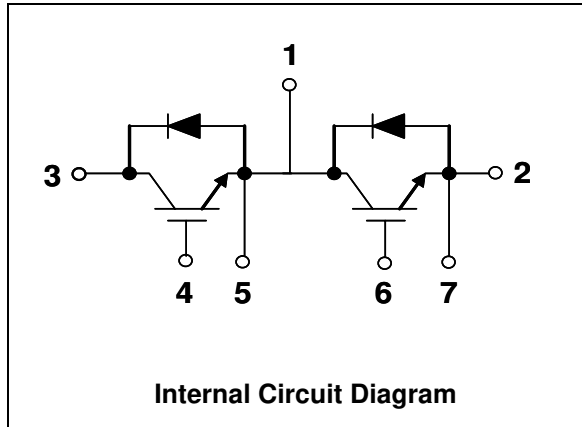

Internal Circuit Diagram

Absolute Maximum Ratings

Symbol	Description	Rating	Units
V _{CES}	Collector-Emitter Voltage	600	V
V _{GES}	Gate-Emitter Voltage	± 20	V
I _C	Collector Current @ T _C = 25°C	100	A
I _{CM(1)}	Pulsed Collector Current	200	A
I _F	Diode Continuous Forward Current @ T _C = 100°C	100	A
I _{FM}	Diode Maximum Forward Current	200	A
T _{SC}	Short Circuit Withstand Time @ T _C = 100°C	10	us
P _D	Maximum Power Dissipation @ T _C = 25°C	400	W
T _J	Operating Junction Temperature	-40 to +125	°C
T _{stg}	Storage Temperature Range	-40 to +125	°C
V _{iso}	Isolation Voltage @ AC 1minute	2500	V
Mounting Torque	Power Terminals Screw : M5	2.0	N.m
	Mounting Screw : M5	2.0	N.m

Pin Configuration and Pin Description

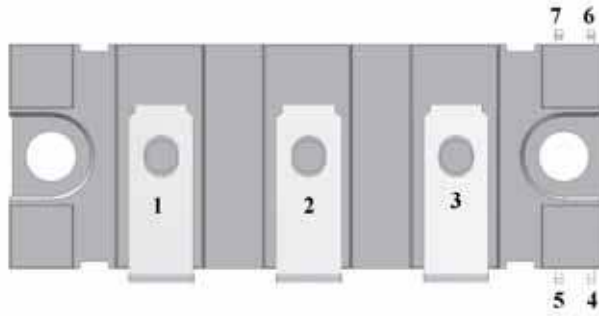

Top View

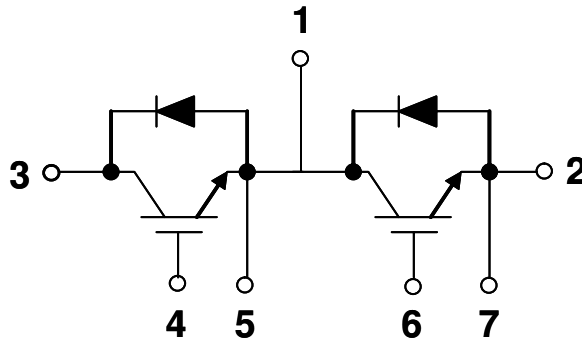

Internal Circuit Diagram

Pin Description

Pin Number	Pin Description
1	Emitter of Q1, IGBT, Collector of Q2, IGBT
2	Emitter of Q2, IGBT
3	Collector of Q1, IGBT
4	Gate of Q1, IGBT
5	Emitter of Q1, IGBT
6	Gate of Q2, IGBT
7	Emitter of Q2, IGBT

Electrical Characteristics ($T_J = 25^\circ\text{C}$, Unless Otherwise Specified)

Symbol	Parameter	Conditions	Min	Typ	Max	Units
--------	-----------	------------	-----	-----	-----	-------

Off Characteristics

BV_{CES}	Collector-Emitter Breakdown Voltage	$V_{GE} = 0V, I_C = 250\mu A$	600	-	-	V
$\frac{\Delta BV_{CES}}{\Delta T_J}$	Temperature Coeff. of Breakdown Voltage	$V_{GE} = 0V, I_C = 1mA$	-	0.6	-	V
I_{CES}	Collector Cut-off Current	$V_{CE} = V_{CES}, V_{GE} = 0V$	-	-	250	μA
I_{GES}	Gate-Emitter Leakage Current	$V_{GE} = V_{GES}, V_{CE} = 0V$	-	-	± 100	nA

On Characteristics

$V_{GE(th)}$	G-E Threshold Voltage	$V_{GE} = 0V, I_C = 100mA$	5.0	6.0	8.5	V
$V_{CE(sat)}$	Collector to Emitter Saturation Voltage	$I_C = 100A, V_{GE} = 15V$	-	2.2	2.8	V

Dynamic Characteristics

C_{ies}	Input Capacitance	$V_{CE} = 30V, V_{GE} = 0V,$ $f = 1MHz$		6085		pF
C_{oes}	Output Capacitance			725		pF
C_{res}	Reverse Capacitance			135		pF

Switching Characteristics

$t_{d(on)}$	Turn-On Delay Time	$V_{CC} = 300V, I_C = 100A,$ $R_G = 2.4\Omega, V_{GE} = 15V$ Inductive Load, $T_C = 25^\circ\text{C}$	-	34	-	ns
t_r	Rise Time		-	24	-	ns
$t_{d(off)}$	Turn-Off Delay Time		-	98	-	ns
t_f	Fall Time		-	45	-	ns
E_{on}	Turn-On Switching Loss		-	0.54	-	mJ
E_{off}	Turn-Off Switching Loss		-	1.26	-	mJ
E_{ts}	Total Switching Loss		-	1.8	-	mJ
$t_{d(on)}$	Turn-On Delay Time	$V_{CC} = 300V, I_C = 100A,$ $R_G = 2.4\Omega, V_{GE} = 15V$ Inductive Load, $T_C = 125^\circ\text{C}$	-	33	-	ns
t_r	Rise Time		-	28	-	ns
$t_{d(off)}$	Turn-Off Delay Time		-	101	-	ns
t_f	Fall Time		-	171	-	ns
E_{on}	Turn-On Switching Loss		-	1.12	-	mJ
E_{off}	Turn-Off Switching Loss		-	3.18	-	mJ
E_{ts}	Total Switching Loss		-	4.3	-	mJ
T_{sc}	Short Circuit Withstand Time	$V_{CC} = 300V, V_{GE} = 15V @ T_C = 100^\circ\text{C}$	10	-	-	μs
Q_g	Total Gate Charge	$V_{CE} = 300V, I_C = 100A, V_{GE} = 15V$	-	283	-	nC
Q_{ge}	Gate-Emitter Charge		-	50	-	nC
Q_{gc}	Gate-Collector Charge		-	155	-	nC

Electrical Characteristics of DIODE ($T_J = 25^\circ\text{C}$, Unless Otherwise Specified)

Symbol	Parameter	Conditions	Min	Typ	Max	Units	
V_{FM}	Diode Forward Voltage	$I_F = 100\text{A}$	$T_C = 25^\circ\text{C}$	-	1.9	2.8	V
			$T_C = 100^\circ\text{C}$	-	1.8	-	
t_{rr}	Diode Reverse Recovery Time		$T_C = 25^\circ\text{C}$	-	85	125	ns
			$T_C = 100^\circ\text{C}$	-	150	-	
I_{rr}	Diode Peak Reverse Recovery Current	$I_F = 100\text{A}$ $di/dt = 200\text{ A/us}$	$T_C = 25^\circ\text{C}$	-	8	11	A
			$T_C = 100^\circ\text{C}$	-	13	-	
Q_{rr}	Diode Reverse Recovery Charge		$T_C = 25^\circ\text{C}$	-	325	635	nC
			$T_C = 100^\circ\text{C}$	-	965	-	

Thermal Characteristics

Symbol	Parameter	Typ.	Max.	Units
$R_{\theta JC}$	Junction-to-Case (IGBT Part, per 1/2 Module)	-	0.25	$^\circ\text{C/W}$
$R_{\theta JC}$	Junction-to-Case (DIODE Part, per 1/2 Module)	-	0.7	$^\circ\text{C/W}$
$R_{\theta CS}$	Case-to-Sink (Conductive grease applied)	0.05	-	$^\circ\text{C/W}$
Weight	Weight of Module	-	90	g

Typical Performance Characteristics

Fig 1. Typical Output Characteristics

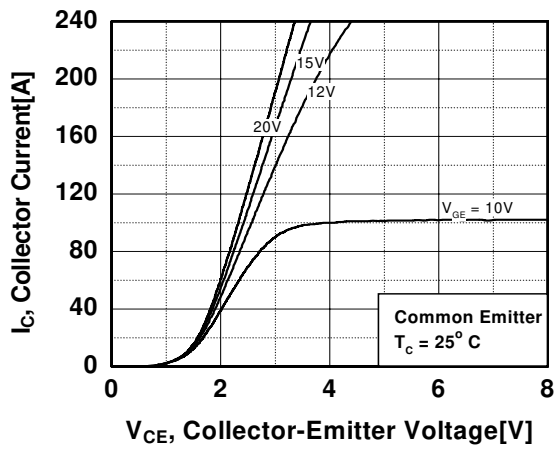

Fig 2. Typical Saturation Voltage Characteristics

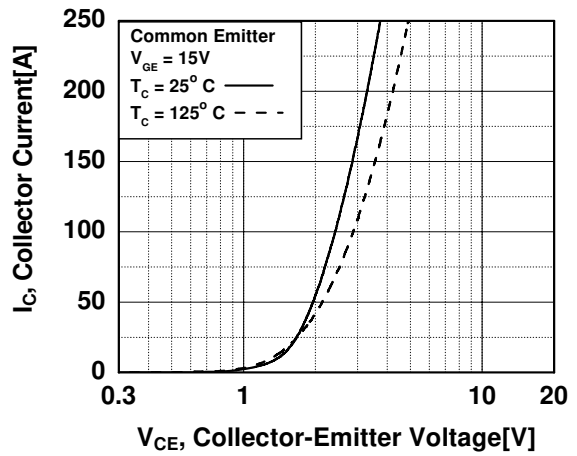

Fig 3. Saturation Voltage vs. Case Temperature at Variant Current Level

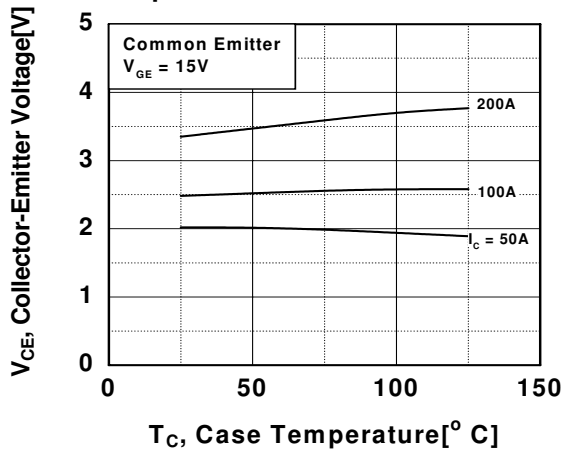

Fig 4. Load Current vs. Frequency

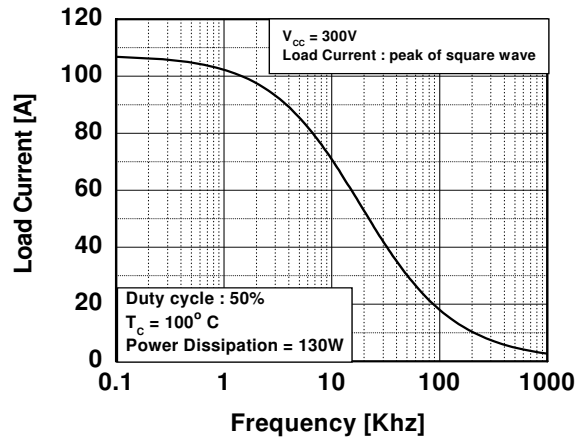

Fig 5. Saturation Voltage vs. V_{GE}

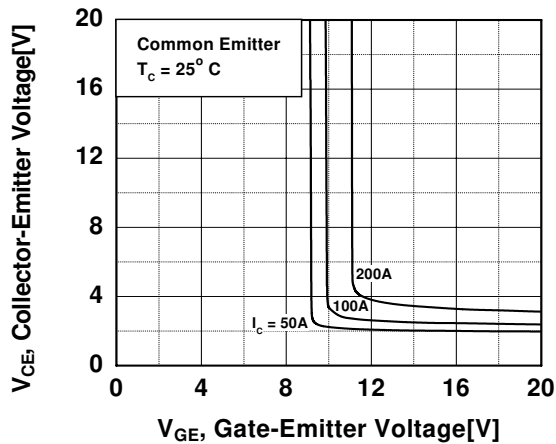

Fig 6. Saturation Voltage vs. V_{GE}

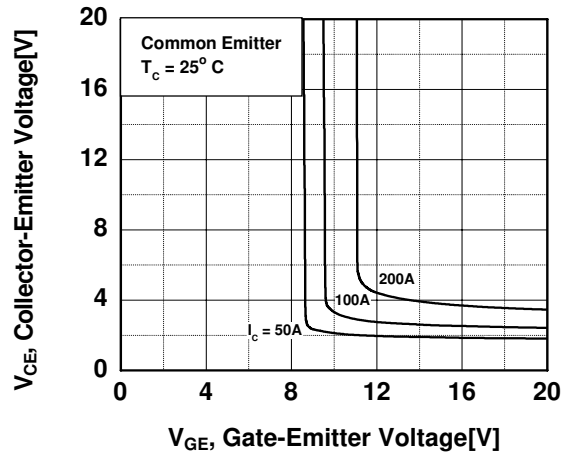

Fig 7. Capacitance Characteristics

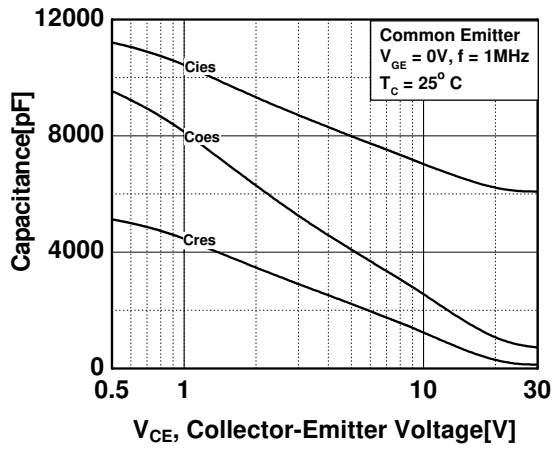

Fig 8. Turn-On Characteristics vs. Gate Resistance

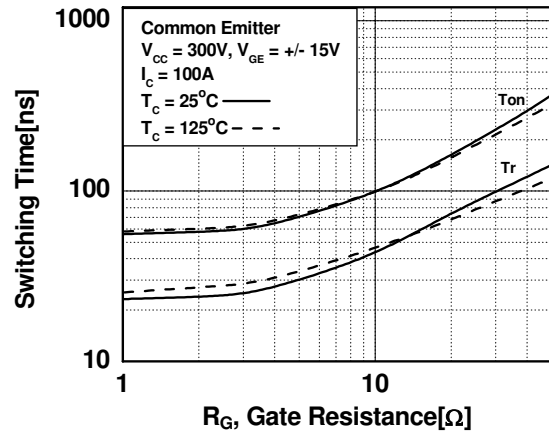

Fig 9. Turn-Off Characteristics vs. Gate Resistance

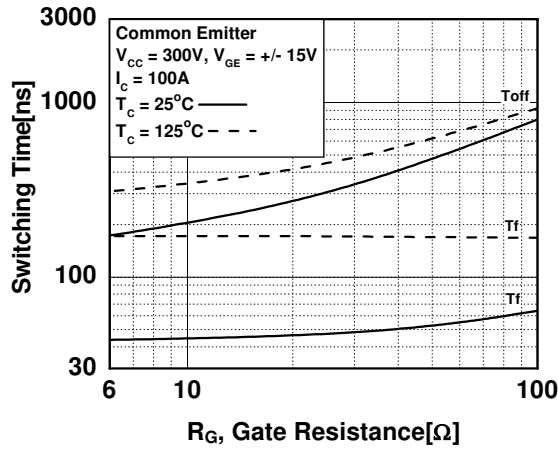

Fig 10. Switching Loss vs. Gate Resistance

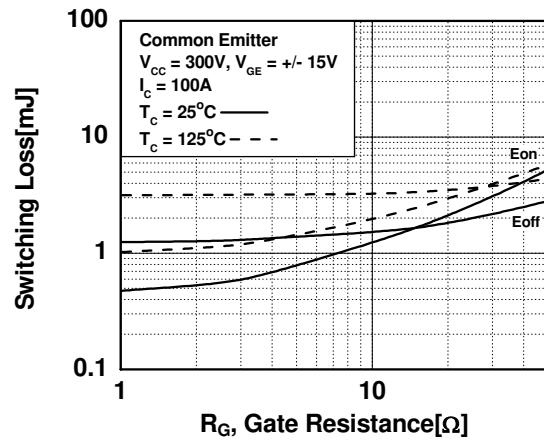

Fig 11. Turn-On Characteristics vs. Collector Current

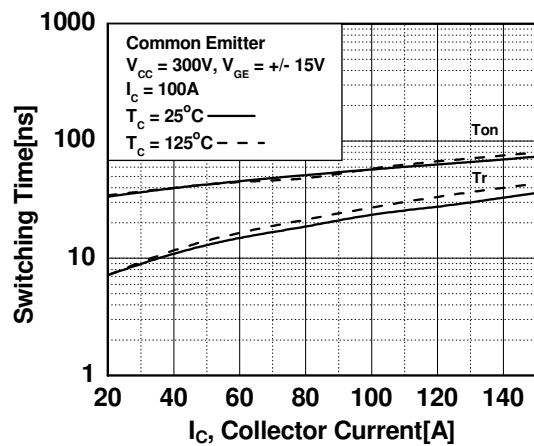

Fig 12. Turn-Off Characteristics vs. Collector Current

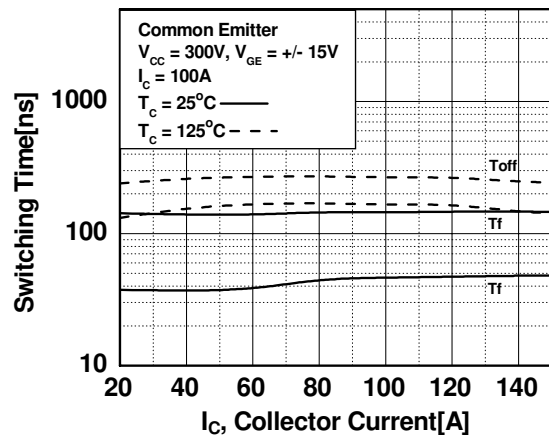

Fig 13. Switching Loss vs. Collector

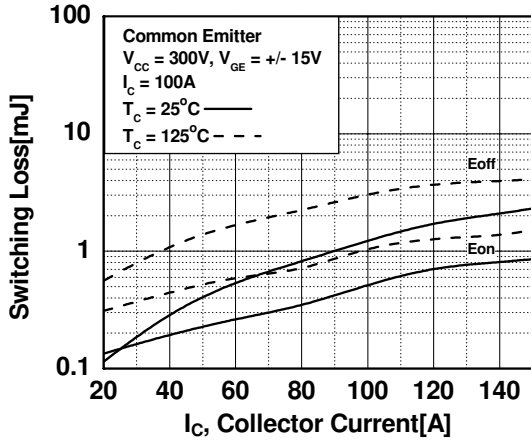

Fig 14. Gate Charge Characteristics

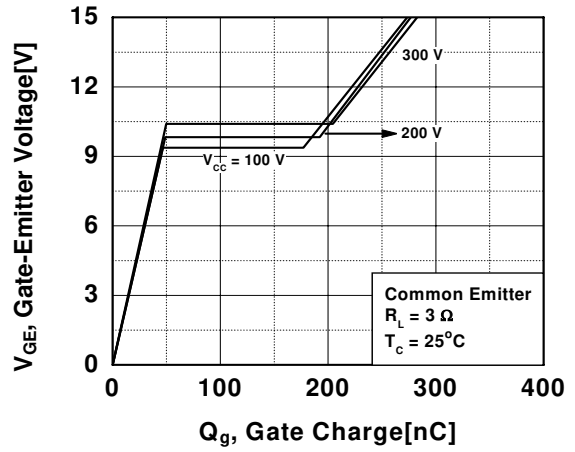

Fig 15. SOA Characteristics

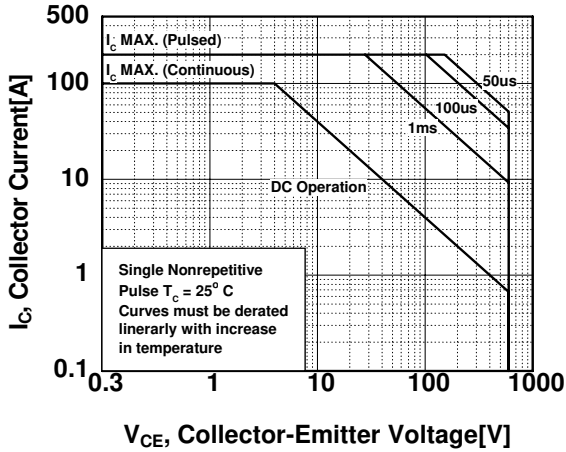

Fig 16. Turn-Off SOA Characteristics

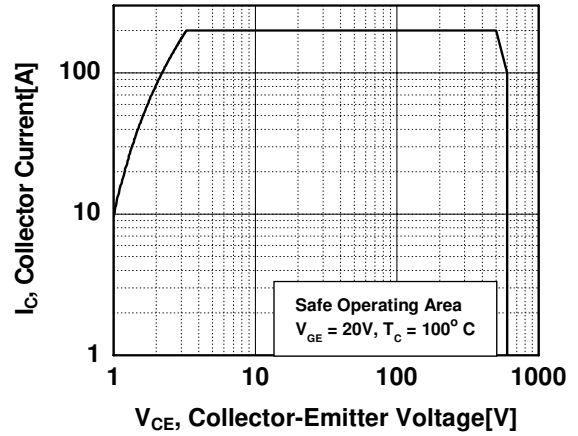

Fig 17. RBSOA Characteristics

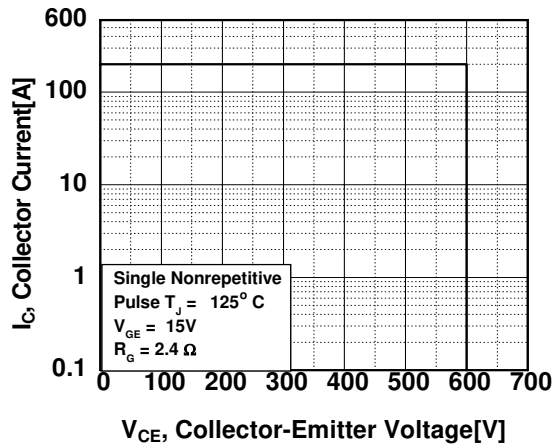

Fig 18. Transient Thermal Impedance

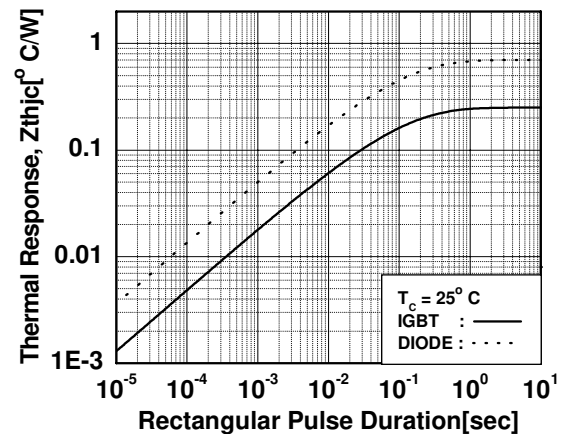

Fig 19. Forward Characteristics

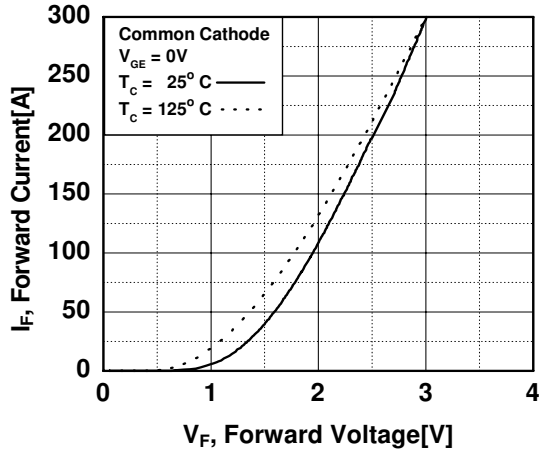
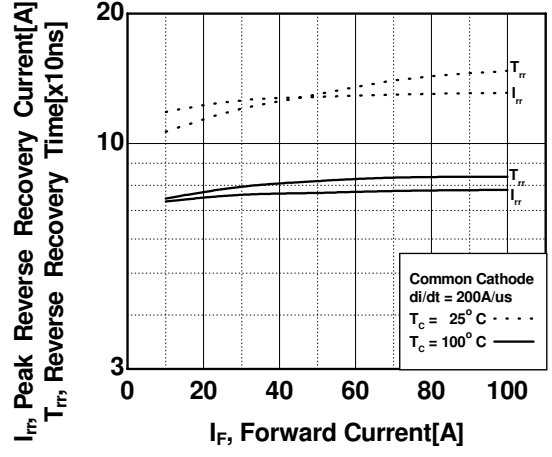
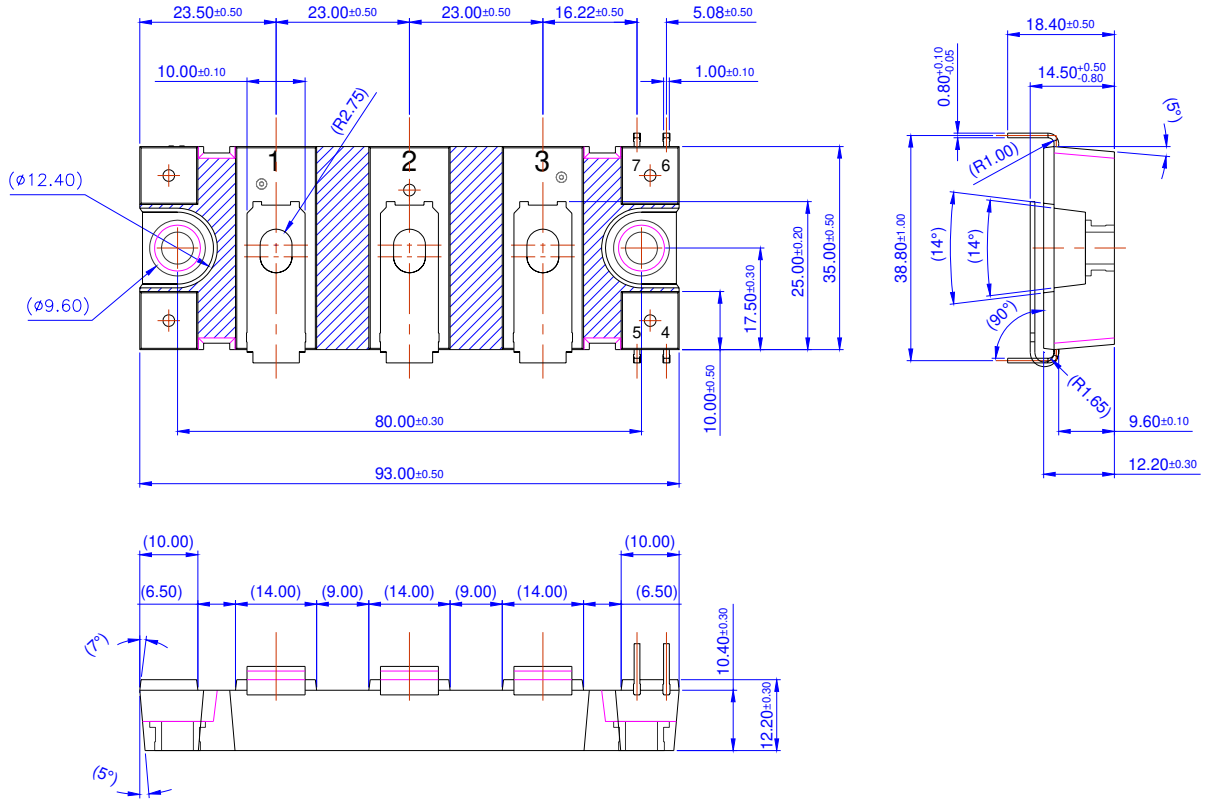

Fig 20. Reverse Recovery Characteristics









Detailed Package Outline Drawings





TRADEMARKS

The following includes registered and unregistered trademarks and service marks, owned by Fairchild Semiconductor and/or its global subsidiaries, and is not intended to be an exhaustive list of all such trademarks.

- | | | | |
|---|---|---|---|
| Build it Now™ | F-PFS™ | PowerTrench® | The Power Franchise® |
| CorePLUS™ | FRFET® | Programmable Active Droop™ | the power franchise |
| CorePOWER™ | Global Power Resource SM | QFET® | TinyBoost™ |
| CROSSVOLT™ | Green FPS™ | QS™ | TinyBuck™ |
| CTL™ | Green FPS™ e-Series™ | Quiet Series™ | TinyLogic® |
| Current Transfer Logic™ | GTO™ | RapidConfigure™ | TINYOPTO™ |
| EcoSPARK® | IntelliMAX™ |  ™ | TinyPower™ |
| EfficientMax™ | ISOPLANAR™ | Saving our world, 1mW/W/kW at a time™ | TinyPWM™ |
| EZSWITCH™ * | MegaBuck™ | SmartMax™ | TinyWire™ |
|  ™ | MICROCOUPLER™ | SMART START™ | μSerDes™ |
|  ® | MicroFET™ | SPM® |  |
| Fairchild® | MicroPak™ | STEALTH™ | UHC® |
| Fairchild Semiconductor® | MillerDrive™ | SuperFET™ | Ultra FRFET™ |
| FACT Quiet Series™ | MotionMax™ | SuperSOT™-3 | UniFET™ |
| FACT® | Motion-SPM™ | SuperSOT™-6 | VCX™ |
| FAST® | OPTOLOGIC® | SuperSOT™-8 | VisualMax™ |
| FastvCore™ | OPTOPLANAR® | SupreMOS™ | |
| FlashWriter® * |  ™ | SyncFET™ | |
| FPS™ | PDP ∩PM™ |  | |
| | Power-SPM™ | | |

* EZSWITCH™ and FlashWriter® are trademarks of System General Corporation, used under license by Fairchild Semiconductor.

DISCLAIMER

FAIRCHILD SEMICONDUCTOR RESERVES THE RIGHT TO MAKE CHANGES WITHOUT FURTHER NOTICE TO ANY PRODUCTS HEREIN TO IMPROVE RELIABILITY, FUNCTION, OR DESIGN. FAIRCHILD DOES NOT ASSUME ANY LIABILITY ARISING OUT OF THE APPLICATION OR USE OF ANY PRODUCT OR CIRCUIT DESCRIBED HEREIN; NEITHER DOES IT CONVEY ANY LICENSE UNDER ITS PATENT RIGHTS, NOR THE RIGHTS OF OTHERS. THESE SPECIFICATIONS DO NOT EXPAND THE TERMS OF FAIRCHILD'S WORLDWIDE TERMS AND CONDITIONS, SPECIFICALLY THE WARRANTY THEREIN, WHICH COVERS THESE PRODUCTS.

LIFE SUPPORT POLICY

FAIRCHILD'S PRODUCTS ARE NOT AUTHORIZED FOR USE AS CRITICAL COMPONENTS IN LIFE SUPPORT DEVICES OR SYSTEMS WITHOUT THE EXPRESS WRITTEN APPROVAL OF FAIRCHILD SEMICONDUCTOR CORPORATION.

As used herein:

1. Life support devices or systems are devices or systems which, (a) are intended for surgical implant into the body or (b) support or sustain life, and (c) whose failure to perform when properly used in accordance with instructions for use provided in the labeling, can be reasonably expected to result in a significant injury of the user.
2. A critical component in any component of a life support, device, or system whose failure to perform can be reasonably expected to cause the failure of the life support device or system, or to affect its safety or effectiveness.

ANTI-COUNTERFEITING POLICY

Fairchild Semiconductor Corporation's Anti-Counterfeiting Policy. Fairchild's Anti-Counterfeiting Policy is also stated on our external website, www.fairchildsemi.com, under Sales Support.

Counterfeiting of semiconductor parts is a growing problem in the industry. All manufacturers of semiconductor products are experiencing counterfeiting of their parts. Customers who inadvertently purchase counterfeit parts experience many problems such as loss of brand reputation, substandard performance, failed applications, and increased cost of production and manufacturing delays. Fairchild is taking strong measures to protect ourselves and our customers from the proliferation of counterfeit parts. Fairchild strongly encourages customers to purchase Fairchild parts either directly from Fairchild or from Authorized Fairchild Distributors who are listed by country on our web page cited above. Products customers buy either from Fairchild directly or from Authorized Fairchild Distributors are genuine parts, have full traceability, meet Fairchild's quality standards for handling and storage and provide access to Fairchild's full range of up-to-date technical and product information. Fairchild and our Authorized Distributors will stand behind all warranties and will appropriately address any warranty issues that may arise. Fairchild will not provide any warranty coverage or other assistance for parts bought from Unauthorized Sources. Fairchild is committed to combat this global problem and encourage our customers to do their part in stopping this practice by buying direct or from authorized distributors.

PRODUCT STATUS DEFINITIONS

Definition of Terms

Datasheet Identification	Product Status	Definition
Advance Information	Formative / In Design	Datasheet contains the design specifications for product development. Specifications may change in any manner without notice.
Preliminary	First Production	Datasheet contains preliminary data; supplementary data will be published at a later date. Fairchild Semiconductor reserves the right to make changes at any time without notice to improve design.
No Identification Needed	Full Production	Datasheet contains final specifications. Fairchild Semiconductor reserves the right to make changes at any time without notice to improve the design.
Obsolete	Not In Production	Datasheet contains specifications on a product that is discontinued by Fairchild Semiconductor. The datasheet is for reference information only.

Rev. I36